

OPERATING INSTRUCTIONS 使用說明書 Air Purifier 空氣清新機

Model No. 型號 **F-PXM35H**

This product is for indoor use only

本產品為室內專用

CONTENTS

SAFETY PRECAUTIONS	2~5
SETTING AND OPERATING REQUIREMENTS	5
MAIN PARTS IDENTIFICATION	8
SETUP	9~10
OPERATION	11~12
• POWER OFF/ON • AIR VOLUME	11
• TURBO TIMER • SLEEP	12
MAINTENANCE	13~15
• CLEANING METHOD	14
• FILTER REPLACEMENT	15
• WHEN IDLE FOR A LONG TIME	15
FURTHER INFORMATION	16~17
FAQ	18
TROUBLESHOOTING	19
SPECIFICATIONS	BACK COVER
OPTIONAL ACCESSORIES	BACK COVER

目錄

安全注意事項	2~5
設置與使用要求	5
主要部件名稱	8
設置	9~10
使用方法	11~12
• 運轉關/開 • 風量	11
• 高速定時器 • 睡眠模式	12
維護保養	13~15
• 清潔方法	14
• 更換過濾網	15
• 長期間置時	15
更多信息	16~17
常見問題解答	18
故障排除	19
規格	末頁
自選配件	末頁

確認與設置
CONFIRMATION
AND SETUP

使用方法
OPERATION
METHOD

維護保養
MAINTENANCE

其他信息
OTHER
INFORMATION

Warranty card attached

附保證書

Thank you very much for purchasing this Panasonic product.
Please read these operating instructions carefully before operation and maintenance.
Also, be sure to read the "SAFETY PRECAUTIONS" section (P.2~5) before use.
Failure to comply with instructions could result in injury or property damage.
Make sure that the correct information is written on the warranty card, including the date of purchase and the name of the distributor. Keep the warranty card in a safe place along with the operating instructions for future reference.

感謝您選購Panasonic產品。

使用和維護產品前，請仔細閱讀本使用說明書。

使用前，請務必先閱讀“安全注意事項”（第2~5頁）。

不遵照本說明書進行操作有可能導致受傷或財產損失。

請確認保證書中已填寫“購買日期、經銷商名稱”等信息後，將其與使用說明書一同進行妥善保管。

SAFETY PRECAUTIONS

安全注意事項

Please strictly follow
請務必遵守

- Disconnect power supply before maintenance.
維護保養前先斷電。
- If the supply cord is damaged, it must be replaced by the manufacturer, its service agent or similarly qualified persons in order to avoid a hazard.
如果電源軟線損壞，為了避免危險，必須由製造商、其維修部或類似部門的專業人員更換。
- This product is not intended for use by persons (including children) with reduced physical, sensory or mental capabilities, or lack of experience and knowledge, unless they have been given supervision or instruction concerning use of the product by a person responsible for the safety.
Children should be supervised to ensure that they do not play with the product.
本產品不適合有殘障、智障或精神障礙的人士，或缺乏經驗、常識者（包括兒童）維護使用，除非在監護人的看護或指導下使用。兒童應該有人進行看護，以防將產品當做玩具。

The safety precautions should be strictly followed in order to prevent injury or damage to properties. 為了避免對您或其他人造成傷害或財物損害，請務必遵守安全注意事項。

- The following symbols differentiate the levels of danger or injury that may result if the product is not used correctly as instructed.
以下標誌是根據不按指示使用產品所產生的危險或受傷程度進行分類。

WARNING 警告

Those things shown in this column indicate that there is possibility of causing death or severe injury.
本標誌所表示的內容為“不遵守的話可能造成人員死亡或重傷”。

CAUTION 注意

Those things shown in this column indicate that there is possibility of causing minor injury or damage to properties.
本標誌所表示的內容為“不遵守的話可能造成人身輕傷或財物損害”。

- The following symbols are used to indicate the type of instructions that need to be followed.
(The symbols given below are examples)
以下標誌為務必遵守的指示種類。（下列標誌為例子。）



This symbol indicates an action that must not be performed.
此標誌表示禁止事項。



This symbol indicates an action that must be performed.
此標誌表示強制事項。

WARNING 警告

-  ■ Do not pull the power cord when carrying or storing the product.
移動或存放時禁止拉扯電源線。
(Otherwise, the power cord may be damaged with the possibility of fire or electric shock.)
(否則電源線可能會損壞，導致火災或觸電。)
- Do not damage the power cord or power plug.
禁止損壞電源線或電源插頭。
 - Do not cut, modify, excessive distort, twist, squeeze the power cord, and do not place it near heat sources, place heavy weight on it, etc.
禁止切割、改裝、過度扭曲、擰絞、擠壓電源線、使電源線靠近熱源以及在電源線上壓放重物等。
(Otherwise, the power cord may be damaged with the possibility of fire or electric shock.)
(否則電源線可能會損壞，導致火災或觸電。)

-  ■ Do not let the product get wet.
禁止弄濕機體。
(Otherwise, the product may short circuit with the possibility of fire or electric shock.)
(否則產品可能會短路，導致火災或觸電。)

- Do not use power other than the rated voltage (220 V~ 50 Hz).
禁止使用額定電壓(220 V~ 50 Hz)以外的電源。
(Otherwise, the power cord may over-heat and induce fire.)
(否則電源線可能會過熱，導致火災。)
- Do not touch the power plug with wet hands.
禁止用濕手接觸電源插頭。
(Otherwise, electric shock may occur.)
(否則可能會導致觸電。)

SAFETY PRECAUTIONS

安全注意事項

Please strictly follow
請務必遵守



WARNING 警告



- Do not insert your fingers, metallic objects or others into the air inlet, air outlet or gaps.
禁止將手指或金屬物等異物放入進風口、出風口或縫隙中。
(Otherwise, you may be hurt by the inner units with the possibility of electric shock or injury.)
(否則可能會接觸到產品內部，導致觸電或受傷。)



- Do not disassemble or modify the product.
禁止擅自拆開或改裝本產品。
(Otherwise, the product may malfunction with the possibility of fire or electric shock.)
(否則產品可能會故障，導致火災或觸電。)
→ Contact the dealer for repair.
需要維修時請聯繫經銷商進行維修。



- Clean the power plug regularly.
請定期清潔電源插頭。
(If dust is found on the power plug, insulation maybe damaged by humidity and fire may occur.)
(如果電源插頭上有灰塵，濕氣可能會破壞電源插頭的絕緣部分，導致火災。)
 - Disconnect the power plug and wipe it with dry cloth.
拔出電源插頭，用乾布擦淨。
 - When the product will not be used for a long period, disconnect the power plug.
長期不使用產品時，應拔出電源插頭。
- Make sure to disconnect the power plug before cleaning the product.
維護保養產品前，請務必拔出電源插頭。
(Otherwise, the product might operate with the possibility of electric shock or injury.)
(否則產品可能會突然運轉，導致觸電或受傷。)
- Insert the power plug completely.
請將電源插頭完全插入電源插座。
(Otherwise, the power cord may over-heating with the possibility of fire or electric shock.)
(否則電源線可能會過熱，導致火災或觸電。)
 - Do not use damaged power plug or loosen power socket.
禁止使用已損壞的電源插頭或鬆動的電源插座。



- In case of any abnormality or malfunction, stop using the product immediately and disconnect the power plug.
當有以下的任何情況出現時，請立即停止使用本產品並拔出電源插頭。
(Otherwise, electric shock, fire or smoke may occur.)
(否則可能會導致觸電、起火或冒煙。)
<Examples of abnormality/malfunction>
<異常·故障的例子>
 - The product stops operating when moving the power cord.
移動電源線時，產品運轉停止。
 - If any switches do not work.
如果任何控制按鈕故障。
 - If the circuit breaker is tripped or when fuse blows.
如果斷路器起作用或保險絲燒毀。
 - If the power cord or power plug becomes abnormally hot.
如果電源線或電源插頭異常發熱。
 - If you notice a burning smell or an abnormal sound or vibration.
如果您發覺有燒焦的異味或異常的聲音或振動。
 - If there is any other abnormalities or malfunction.
如果有其他任何異常現象或故障。
- Please stop using the product immediately and disconnect the power plug, and contact the dealer to check and repair.
立即停止使用，拔出電源插頭，聯繫經銷商進行檢查、維修。

SAFETY PRECAUTIONS

安全注意事項

Please strictly follow
請務必遵守

⚠ CAUTION 注意



■ Do not place the product in the following places.

禁止放置本產品於以下場所。

- Incline and unstable place.
不平穩的場所。
(Otherwise, the product may fall over and injury may occur or damage the product.)
(否則產品可能會翻倒，導致受傷或產品損壞。)
- Where the temperature or humidity is extremely high, or watery area, such as bathroom.
浴室等高溫、高濕或會弄濕產品的場所。
(Otherwise, current may leak with the possibility of fire or electric shock.)
(否則產品可能會漏電，導致火災或觸電。)
- Where oil fume is emitted, such as in kitchens.
廚房等排放油煙的場所。
(Otherwise, the product may crack and injury may occur.)
(否則產品可能會破裂，導致受傷。)
- Where oil or inflammable gas is present and may be leaked.
使用油或可燃性氣體並可能出現洩漏的場所。
(Otherwise, a fire may occur due to ignition in the product.)
(否則產品吸入後可能會起火，導致火災。)
- Where the air outlet faces animals or plants directly.
出風口正對動植物的場所。
(Otherwise, it may cause discomfort to the animals and dry out the plant.)
(否則可能會導致動物不適、植物風乾。)

■ Do not place the product near combustible materials such as lighted cigarette, incense, etc.

禁止將點燃的香煙、香燭等可燃物接近產品。

(Otherwise, these may be absorbed into the product with possibility of fire.)
(否則產品吸入易燃物後可能會起火，導致火災。)



■ When disconnecting the power plug, hold the power plug instead of the power cord.

請手持電源插頭部位拔出電源插頭。

(Otherwise, the power cord may be damaged with the possibility of fire or electric shock.)

(否則電源線可能會損壞，導致火災或觸電。)



■ Do not clean the product with gasoline or other volatile mixture solvents, and avoid contacting with spray insecticides.

禁止使用汽油或其他揮發性混合溶劑擦拭產品，以及把殺蟲劑噴到產品上。

(Otherwise, the product may crack or short circuit with the possibility of injury, fire or electric shock.)

(否則產品可能會破裂或短路，導致受傷、火災或觸電。)

■ Do not operate this product in places where indoor fumigation type insecticides are being used.

使用煙熏型殺蟲劑時禁止使用本產品。

(Chemical residue may build up inside the product and discharge from the air outlet, and cause damage to health.)
(否則化學殘留物可能會在產品內積聚，然後從出風口排出，危害身體健康。)

→ Ventilate the room with fresh air thoroughly after using insecticides before operating the product.

使用殺蟲劑後，應先讓房間徹底通風，然後才可使用本產品。

■ Do not sit on or lean against this product.

禁止坐、靠本產品。

(Otherwise, the product may fall over and injury may occur or damage the product.)

(否則產品可能會翻倒，導致受傷或產品損壞。)

- Families with children should pay more attention.

有小孩的家庭要多加注意。



■ When carrying the product, please hold the left and right handles, but not the front panel.

移動產品時請握住兩側把手，請勿握住前面板。

(Otherwise, the product may fall off, injury may occur.)

(否則產品可能會掉落，導致受傷。)

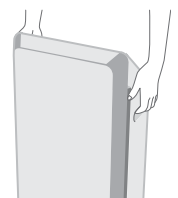

SAFETY PRECAUTIONS

安全注意事項

Please strictly follow
請務必遵守

⚠ CAUTION 注意



■ Keep the room well-ventilated when using the product together with a burner.

與燃燒器具一起使用時，需保持空氣流通。

(Otherwise, carbon monoxide poisoning may occur.)

(否則可能會導致一氧化碳中毒。)

- This product cannot remove carbon monoxide.

本產品不能去除一氧化碳。

SETTING AND OPERATING REQUIREMENTS

設置與使用要求

確認與設置
AND SETUP

Area that can enhance the effectiveness!

在這些場所使用，非常有效！

■ Way to against PM2.5 and indoor dust, etc.

針對PM2.5、室內揚塵等。

We recommend you to place the product on flat floor in the room.

建議將本產品設置在房間平坦的地面上。

■ Way to circulate air more effectively.

使房間裡的空氣有效循環。

Place the product with its left, right and top about 30 cm or more away from walls, furniture or curtains, etc. Otherwise, the pollutants are difficult to be cleared.

To ensure effectiveness of this product, keep its back at least 1 cm away from the wall.

請將本產品設置在其左右與上方距離牆壁、傢俱、窗簾等約30 cm以上的地方，否則污染物難以被吸入機體。

為了更有效地使用本產品，請保持產品背部距離牆壁至少1 cm。



■ If the product is used in the same place for a long period.

在同一場所長時間使用時。

Using the product continuously at the same location may result in dirty surrounding walls or floor. We recommend that you move the product away from where it is placed when maintenance it.

在同一場所長時間使用時，產品周圍的牆壁及地板會髒污。建議進行產品維護保養時，改變設置場所。

■ Do not use the same power socket with TV, radio, etc.

請勿與電視機、收音機等設備使用同一電源插座。

(Otherwise, visual disturbances or noises may be caused.)

(電源插頭插入時有可能會產生影像紊亂以及雜音。)

→ In this case, insert the power plug into another power socket.

請將電源插頭插到其他電源插座上。

■ Do not set the product in the following places.

請勿設置本產品於以下場所。

- Where the product will be exposed directly to sunlight, outlet of air conditioner or heat, etc.

陽光直射、被空調吹到或受熱等場所。

(Otherwise, deformation, degeneration, discolor or malfunction may be occurred.)

(否則可能會造成變形、老化、變色或故障。)

- Near equipment such as TV and radio.

電視機及收音機等設備附近。

(Otherwise, visual disturbances or noises may be caused.)

(否則可能會導致影像紊亂以及雜音。)

→ Keep the product 1 m or above away from such devices.

請距離這些設備1 m以上設置。

“House Dust Catcher” and “nanoe[®]” give you clean and fresh air.

- House Dust Catcher completely cleaning dust from the air near the floor
- Equipped with nanoe[®] technology
- Compact and stylish design

採用“室內微塵捕捉器”和“nanoe[®]”技術，締造清淨家居。

- 室內微塵捕捉器徹底清除靠近地面空氣中的灰塵
- 配備nanoe[®]技術
- 機身設計纖細緊湊

■ About nanoe[®] 關於nanoe[®]

nanoe[®] is a microparticle ion wrapped in water by the latest technology.

nanoe[®]是以最先進的科技創造的水合電離子微粒。

With nanoe[®] technology, the effects of sterilization^{★**1}, allergens inhibition^{**2}, fungi elimination^{**3} and deodorization^{**4} can be achieved, thereby creates a conducive environment for hydrated skin.

依靠nanoe[®]技術，能有效除菌^{★**1}、抑制過敏原^{**2}、殺滅真菌^{**3}、去除附著性氣味^{**4}等，從而打造出美膚空間。



★ <airborne fungi> The result is of a 4-hour test in a closed space of 25 m³, instead of in actual application space.

<浮動真菌>是在25 m³密閉空間下測試4小時後得出的效果，並非實際使用空間效果。

★ <adhered bacteria> The result is of a 8-hour test in a closed space of 23 m³, instead of in actual application space.

<附著細菌>是在23 m³密閉空間下測試8小時後得出的效果，並非實際使用空間效果。

※1 < airborne fungi > <浮動真菌>

● Test organization: Kitasato Research Center of Environmental Sciences

實驗機構：財團法人北里環境科學中心

● Test method: directly expose and measure the fungi count collected in a test space of 25 m³

實驗方法：直接放置在25 m³的實驗空間內，測定所收集的真菌數量

● Sterilization method: release nanoe[®]

除菌方法：釋放nanoe[®]

● Target: airborne fungi

實驗對象：浮動真菌

● Test outcome: eliminated 99% and above in 4 hours (Test number 24_0301_1)

實驗結果：經過4小時後，殺滅99%以上的浮動真菌（北生發24_0301_1號）

< adhered bacteria > <附著細菌>

● Test organization: Japan Food Research Laboratories

實驗機構：財團法人日本食品分析中心

● Test method: measure the bacteria count adhered on the fabric in a test space of 23 m³

實驗方法：測定在23 m³實驗空間內，附在布塊上的細菌數量

● Sterilization method: release nanoe[®]

除菌方法：釋放nanoe[®]

● Target: bacteria adhered on the standard fabric

實驗對象：附在標準布塊上的細菌

● Test outcome: eliminated 99% and above in 8 hours [Test number 13044083003-01]

(With one type in variety of bacteria to test)

實驗結果：經過8小時後，殺滅99%以上的附著細菌（第13044083003-01號）

（採用各種各樣細菌中的一種進行實驗）

- ※2 ● Test organization: Panasonic Corporation Analysis Center
 實驗機構：松下解析中心（株式會社）
 - Test method: measure the allergens adhered on the fabric in a test space of 23 m³ with ELISA method
 實驗方法：採用ELISA法測定在23 m³實驗空間內附在布塊上的過敏原
 - Inhibiting method: release nanoe®
 抑制方法：釋放nanoe®
 - Target: pollen allergens
 實驗對象：花粉過敏原
 - Test outcome: inhibited 88% and above in 8 hours [BAA33-130402-F01]
 實驗結果：經過8小時後，抑制88%以上的過敏原（BAA33-130402-F01）
- ※3 ● Test organization: Japan Food Research Laboratories
 實驗機構：財團法人日本食品分析中心
 - Test method: measure the fungi count adhered on the fabric in a test space of 23 m³
 實驗方法：測定在23 m³實驗空間內，附在布塊上的真菌數量
 - Sterilization method: release nanoe®
 除菌方法：釋放nanoe®
 - Target: adhered fungi
 實驗對象：附著真菌
 - Test outcome: confirmed the effect after 8 hours [Test number 13044083002-01]
 實驗結果：經過8小時後確認效果（第13044083002-01號）
- ※4 ● Test organization: Panasonic Corporation Analysis Center
 實驗機構：松下解析中心（株式會社）
 - Test method: conduct verification by using 6-phase odor intensity in a test space of 23 m³
 實驗方法：在23 m³的實驗空間內，採用6個等級的臭氣強度標記法進行驗證
 - Deodorizing method: release nanoe®
 除臭方法：釋放nanoe®
 - Target: adhered cigarette odor
 實驗對象：附著煙味
 - Test outcome: odor intensity dropped to 1.2 after 2 hours [BAA33-130125-D01]
 實驗結果：經過2小時後，臭氣強度下降至1.2等級（BAA33-130125-D01）

- This is nanoe® device verification result, it is different from the verification of this product.
 此為nanoe®裝置的驗證結果，它與本產品的驗證結果不同。
- The deodorizer effect differs according to the surrounding environment (temperature, humidity), operation time, type of odor or fiber.
 除臭效果會根據周圍環境（溫度、濕度）、運作時間、不同種類的臭氣或纖維而有所不同。
- This product is not a medical equipment.
 本產品不屬於醫療器材。

Note: nanoe® and the nanoe® mark are trademarks of Panasonic Corporation.
 注：nanoe® 和nanoe® 標記為松下電器產業株式會社商標。

MAIN PARTS IDENTIFICATION

主要部件名稱

Front
正面

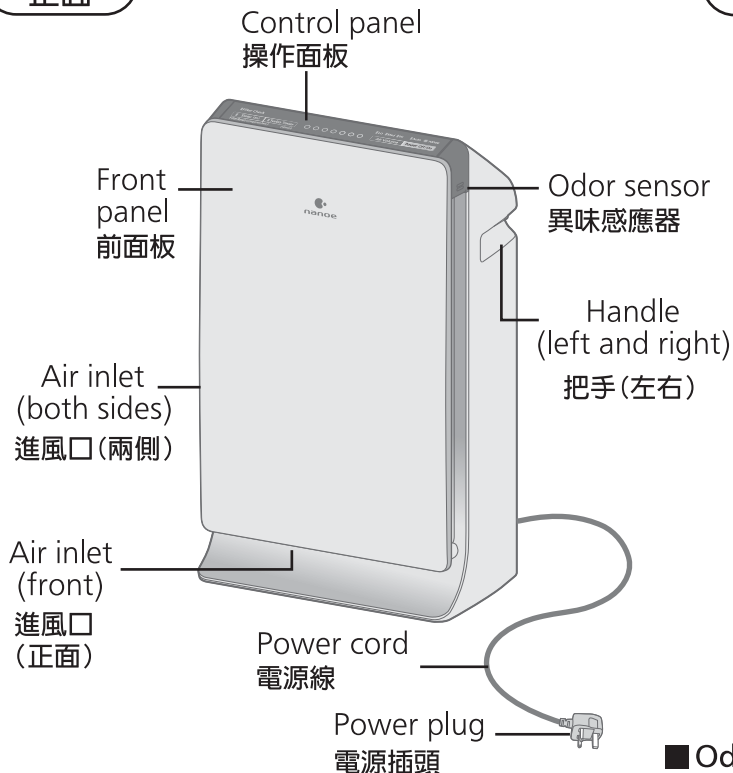

Back
背面

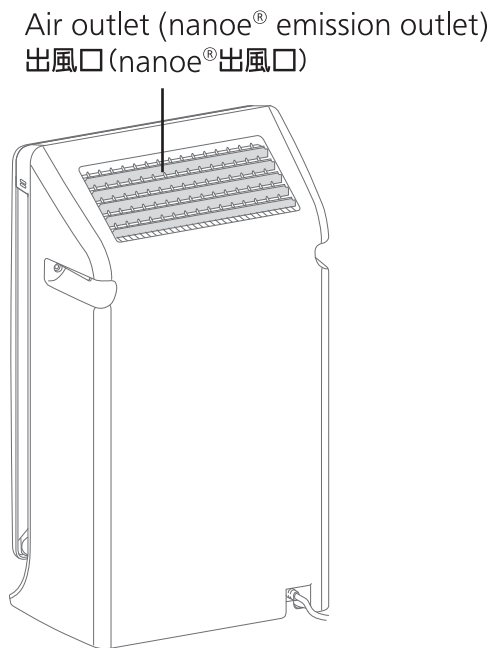

■ Odor sensor

異味感應器

Odor sensor can detect odor such as smoke, etc. The sensitivity of sensor can be adjusted. (P.17)
異味感應器能檢測煙味等異味。感應器靈敏度可調節。(第17頁)

Control panel 操作面板

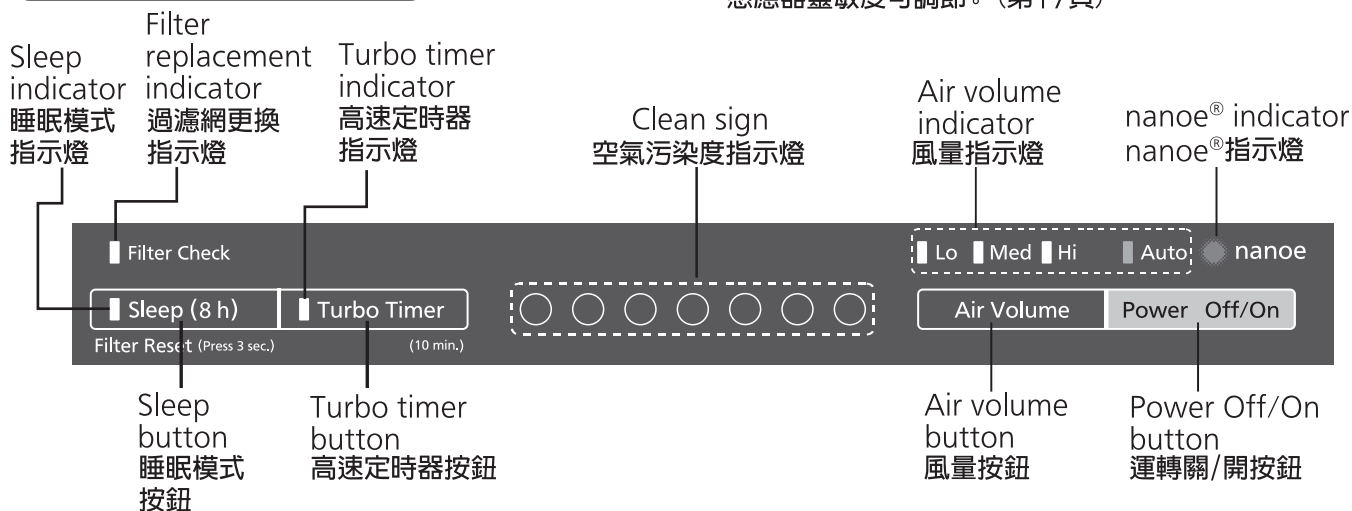

■ nanoe® indicator nanoe®指示燈

The indicator lights on indicates nanoe® is being generated. nanoe® will be generated in all operation modes except you switch off it. (P.16)

指示燈亮起提示正在產生nanoe®。在所有運轉模式下都會產生nanoe®, 除非關閉nanoe®功能。(第16頁)

■ Clean sign 空氣污染度指示燈

Show the air pollution levels detected by odor sensor. The clean sign can be turned off. (P.18)
顯示異味感應器檢測的空氣污染程度。空氣污染度指示燈能關閉。(第18頁)

- ○ ○ ○ ○ ○ ○ ○ ○ ○ ○ Indicates clean 表示乾淨
- ○ ○ ○ ○ ○ ○ ○ ○ ○ ○ Indicates slight dirty 表示有點髒
- ○ ○ ○ ○ ○ ○ ○ ○ ○ ○ Indicates dirty 表示髒

SETUP

設置

Before startup 開機準備

- 1 Fill in the label with the first date of use.
填寫開始使用日期。

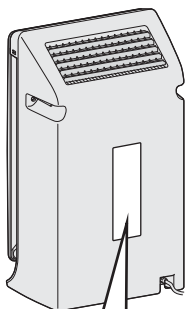

- HEPA composite filter replacement
- About once every 3 years.

Replacement filter
Part No. F-ZXMP35Z

Date installed:

- Deodorizing filter replacement
- Replace a new one when the deodorizing function becomes less effective (About once every 3 years)

Replacement filter
Part No. F-ZXFD35X

Date installed:

Notice 提示事項

Make sure to read page 2~5 before setting up the product.
設置產品前請務必閱讀第2~5頁。

Install filters 安裝過濾網

- 2 Remove the deodorizing filter from the poly bag.
從塑膠袋中取出脫臭過濾網。

- ① Remove the front panel.
拆下前面板。

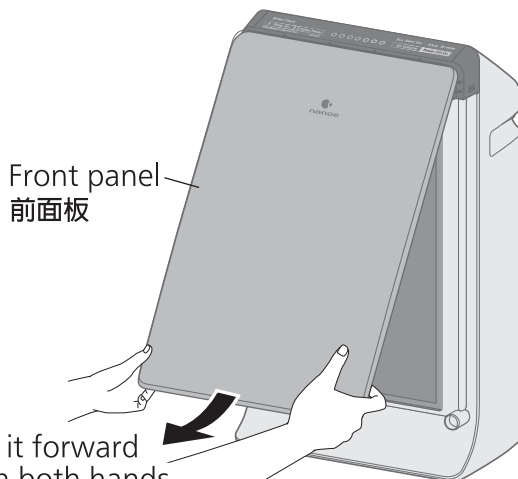

Front panel
前面板

Pull it forward with both hands
雙手向前拉出

- ② Remove the filters (2 types).
拆下過濾網(2種)。

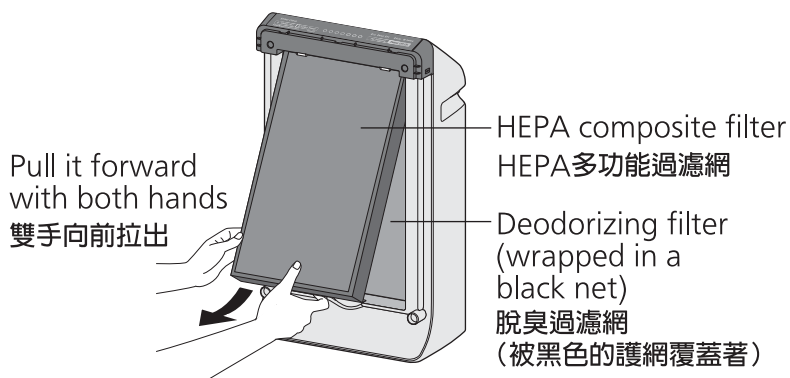

Pull it forward with both hands
雙手向前拉出

HEPA composite filter
HEPA多功能過濾網

Deodorizing filter (wrapped in a black net)
脫臭過濾網 (被黑色的護網覆蓋著)

- ③ Remove the deodorizing filter from the poly bag.
從塑膠袋中取出脫臭過濾網。

Notice 提示事項

Please don't remove the black net of deodorizing filter.
請勿取下脫臭過濾網上黑色的護網。

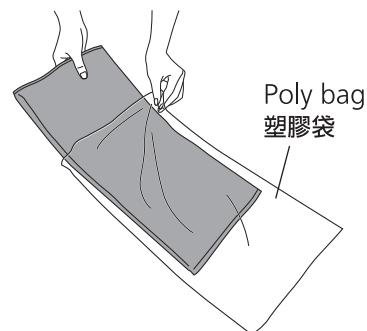

Poly bag
塑膠袋

SETUP

設置

Install filters 安裝過濾網

3 Install the filters (2 types) and front panel. 安裝過濾網(2種)和前面板。

- ① Install deodorizing filter.
(There is no distinction between inside and outside, upper and lower)
安裝脫臭過濾網。(無內外、上下的區分)

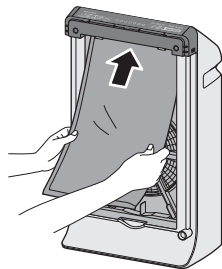

- ② Install HEPA composite filter.
(There is distinction between inside and outside, no distinction between upper and lower)
安裝HEPA多功能過濾網。(有內外的區分、無上下的區分)

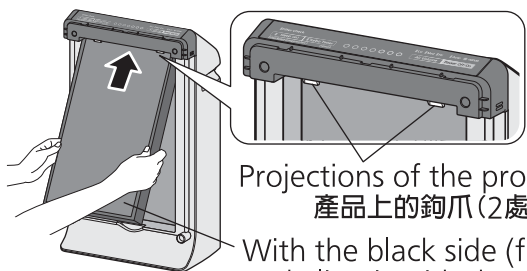

Projections of the product (2 places)
產品上的鉤爪(2處)

With the black side (front side) outside, and align it with the projections of the product.

將黑色面(正面)朝外，使與產品上的鉤爪咬合。

- ③ Install front panel.
安裝前面板。

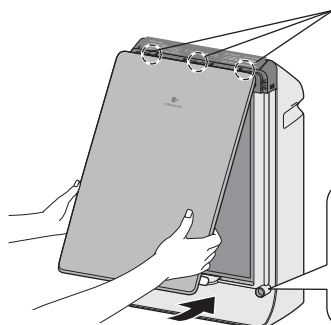

Fit the clutch into the indentation (3 places) of the product.

使產品上的凹槽(3處)與鉤爪咬合。

Push in the protrusion into holes (2 places) of product and press properly.

將前面板的凸起處插入產品上的小孔(2處)，並且向下按到底。

Notice 提示事項

Be sure to install front panel before use.
使用前請務必安裝好前面板。

Power-on 接通電源

4 Connect the power plug. 插入電源插頭。

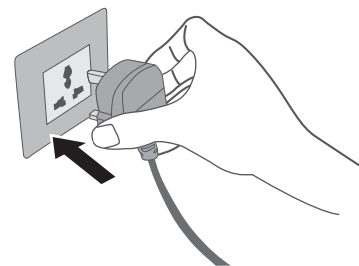

- When inserting the power plug, as the odor sensor uses the degree of cleanliness at this time as the standard, we recommend that you plug it in when the air is fresh (such as when there is no cigarette smoke). (The standard of the odor sensor automatically updates itself according to the degree of the indoor cleanliness.)
因為異味感應器以插入電源插頭時的空氣清潔度作為基準，所以建議當室內空氣清潔時(如沒有煙味時)，插入電源插頭。(異味感應器的基準會根據室內的空氣清潔度自動更新。)

- Press **Power Off/On** button, then the clean sign blinks for about 5 seconds.

按下 **Power Off/On** 按鈕，空氣污染度指示燈閃爍約5秒。

OPERATION

使用方法

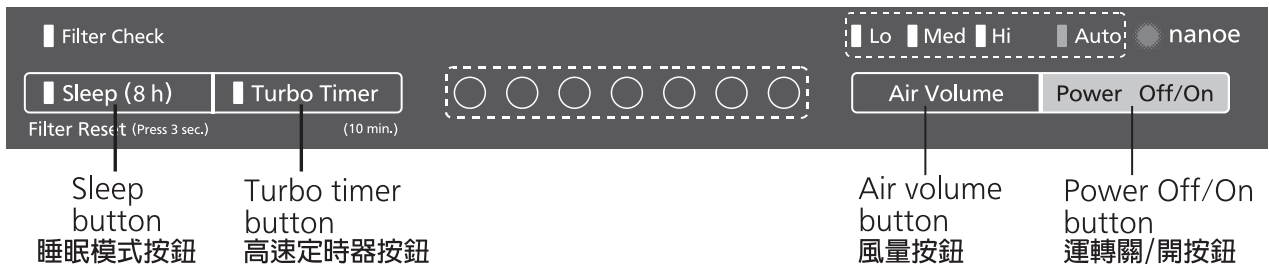

Power Off/On 運轉關/開

Power Off/On



Turn on or off the product.

開始或停止運轉。

Press the button to operate. (Air volume indicator lights on)
按下按鈕產品開始運轉。(風量指示燈亮起)

1. When using for the first time, operation will begin with the air volume under "Auto".
初次運轉時以自動風量模式運轉。
2. Other than the above situations, operation will begin with the air volume from the last time it was stopped.
上述以外的情況下，產品會以上次停止時的風量運轉。
3. Press the button again, the product stops operating.
再次按下此按鈕，產品停止運轉。

■ To operate product within 2 minutes after the power plug is inserted, the indicator of air volume under "Auto" will blink about 2 minutes, what it indicates the odor sensor is in the stanby mode.

插入電源插頭後2分鐘內運轉產品時，風量的 "Auto" 指示燈將閃爍約2分鐘，這提示異味感應器在準備狀態。

Air volume 風量

Air Volume



Select appropriate air volume for purifying air.

選擇合適的風量淨化空氣。

The indicator will be changed sequentially as figure below.
每按一下，指示燈將按下圖順序進行切換。

Automatically adjust the air volume according to the air pollution detected by sensor, and use appropriate air volume to purify air.

根據感應器檢測的空氣污染程度，自動調節風量，利用最佳的風量淨化空氣。

Auto

Purify air quietly in low speed.
低速安靜地淨化空氣。

Lo

Purify air in medium speed.
以中等速度淨化空氣。

Med

Purify air quickly.
快速淨化空氣。

Hi

(Indicator lights on)
(指示燈亮起)

OPERATION

使用方法

Turbo Timer 高速定時器

Turbo Timer

Turbo operation.

高速運轉。

(Indicator lights on)
(指示燈亮起)

Press this button to begin turbo operation.

按下按鈕開始高速運轉。

• During turbo operation, the clean sign will flash in blue and red.
After 10 minutes, the turbo operation ends and will return to the previous operation mode.

高速運轉時，空氣污染度指示燈將閃爍為藍色和紅色。10分鐘後，高速運轉結束並恢復到之前的運轉模式。

■ Press the button again to deactivate turbo operation.
(The indicator turns off.)

再次按下此按鈕，取消高速運轉。（指示燈熄滅）

Sleep 睡眠模式

Sleep (8 h)

Sleeping operation.

睡眠模式運轉。

(Indicator lights on)
(指示燈亮起)

When this button is pressed, the clean sign will turn off and operate with low air volume.

After 8 hours, the sleeping operation ends and the product stops operating.
按下按鈕，空氣污染度指示燈將熄滅並以低速風量運轉。8小時後，睡眠模式運轉結束且產品停止運轉。

■ Press the button again to deactivate sleeping operation.
(The indicator turns off.)

再次按下此按鈕，取消睡眠模式運轉。（指示燈熄滅）

Notice 提示事項

■ If power failure occurs when product is operating, the product will restart automatically when power on again, and operate in the mode when power failure.

如果產品運轉時斷電了，當再次來電時，產品將自動重啟並以斷電時的模式進行運轉。

CARE AND MAINTENANCE

維護保養



WARNING 警告



Make sure to disconnect the power plug before cleaning the product.

維護保養前，請務必拔出電源插頭。
(Otherwise, the product might operate with the possibility of electric shock or injury.)
(否則產品可能會突然運轉，導致觸電或受傷。)

Notice 提示事項

- For installation and removal methods of front panel and filters, please read P.9~10.
前面板及過濾網的拆卸及安裝方法見第9~10頁。
- When cleaning, do not leave the removed parts unattended.
(Otherwise, it may cause tripping or damage.)
進行維護時，請勿隨意擺放拆卸的零件。
(否則可能會絆倒路人或造成零件損壞。)
- Do not operate the product when the HEPA composite filter is removed.
(Dust will be inhaled into product inner parts, and causes the product breakdown. The HEPA composite filter cannot function while it is removed.)
HEPA多功能過濾網未安裝時，請勿使用本產品。
(將失去除塵效果，灰塵進入產品內將造成故障。)
- Do not operate the product when the deodorizing filter is removed.
(The deodorizing filter cannot function while it is removed.)
脫臭過濾網未安裝時，請勿使用本產品。
(將失去脫臭效果。)
- When using chemically treated cloth, be sure to follow the instructions carefully.
使用經過化學處理的抹布時，請務必按說明操作。
- Do not use the detergents shown below.
請勿使用如下所示的洗滌劑。



CARE AND MAINTENANCE

維護保養

Cleaning method 清潔方法

Deodorizing filter

脫臭過濾網

Free from maintenance

無需進行維護保養

- When there is dust around the deodorizing filter, remove the dust with a vacuum cleaner, etc.
周圍附著塵埃時，請用吸塵器等去除。
- Do not wash the filter with water.
請勿水洗。

HEPA composite filter < about once every 2 weeks > HEPA多功能過濾網 <約2周1次>

Clean the black (front) side with a vacuum cleaner, etc.

用吸塵器等去除黑色面(正面)的灰塵

- Please do not punch too much, otherwise the filter may be damaged.
請勿用力按壓，否則過濾網可能會受損。
- Maintenance is unnecessary for the white side (back side).
白色面(背面)無需進行維護保養。
- Do not wash the filter with water.
請勿水洗。

Lay with newspapers, etc to avoid dust messing floor.
墊上報紙等物品，以免灰塵弄髒地面。

Dusting brush nozzle
or gap suction nozzle
毛刷吸嘴或縫隙吸嘴

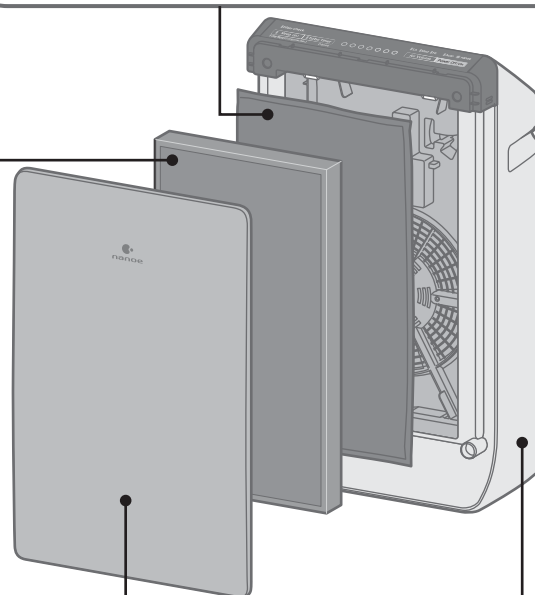
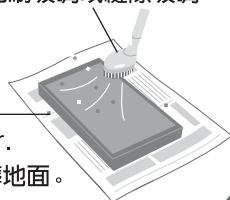

Body and front panel < about once a month > 前面板及機體<約每月1次>

Wipe off any dust and dirt using a well wrung-out cloth
使用充分擰乾的軟布擦拭污垢

- Do not wipe it with a hard cloth or hardly. Otherwise, the surface may be damaged.
請勿使用粗布擦拭或過度用力擦拭，否則會損傷表面。
- Wipe the power plug with a dry cloth.
請使用乾布擦拭電源插頭。

CARE AND MAINTENANCE

維護保養

Filter replacement

更換過濾網

	HEPA composite filter HEPA多功能過濾網	Deodorizing filter 脫臭過濾網
Replacement period 更換週期	When the filter replacement indicator lights on. (About once every 3 years) * 過濾網更換指示燈亮起時(約3年1次)*	
Conditions 條件	When the product inhales the smoke of six cigarettes every day. (Japan Electrical Manufacturers' Association JEM1467) 當產品每天吸入6支香煙時 (日本電機工業協會標準JEM1467)	

(Optional accessories: back cover)
(自選配件: 未頁)

* Filter replacement period may be shortened, depending on the environment (such as where smoking is frequent). Please replace it when ineffective. 根據使用場所等實際情況(如吸煙人數較多的家庭), 過濾網的更換週期可能會縮短, 當過濾效果不好時請及時更換。

- ① After replacement, please connect power plug, then press **Sleep (8 h)** button for about 3 seconds until the filter exchange indicator turns off, then the reset is completed.
更換過濾網後, 請插入電源插頭, 按住 **Sleep (8 h)** 按鈕約3秒, 過濾網更換指示燈熄滅則重置完成。
- ② Fill in installation date on the label attached with filter, then stick it on product to cover the old date. (P.9)
請在過濾網隨附的標籤上記錄開始使用日期, 並粘貼在機體上, 覆蓋舊的使用日期。(第9頁)

Notice 提示事項

- The filter which needs to exchange cannot be used again even is cleaned, please dispose it as non-flammable garbage.
即使清潔乾淨, 達到更換週期的過濾網也不可再被使用, 請將它作為不可燃垃圾處理。
- If the product is used in a room (especially hotel) with strong odor such as aromatic smell, cigarette smoke or barbecue smell, these odors may adhere to the filter, when the adsorption capacity of the filter reaches saturation, odor will also be blown out again with the wind because of excess adsorption. When there is above situation, please clean the HEPA composite filter and deodorizing filter. If the situation persists, please replace the above filters, even if the filter replacement indicator is off. In addition, if often used in a room with strong odor, please open the windows to ventilate the room regularly.
如果在有芳香劑、香煙或烤肉等氣味濃烈的環境下(特別是酒店)使用, 異味有可能會附著在過濾網上; 當過濾網的吸附能力達到飽和後, 氣味也會因吸附過盈而隨風再次被吹出。當發生以上情況時, 請對HEPA多功能過濾網與脫臭過濾網進行維護保養; 若保養後仍有異味吹出, 即使過濾網更換指示燈沒有亮起, 也請對上述過濾網進行更換。另外, 若經常在氣味濃烈的環境下使用, 建議定期針對室內開窗進行通風換氣。

When idle for a long time

長期閒置時

- ① Disconnect power after turning off the product. (The product still consumes power even at rest.)
停止運轉產品並拔出電源插頭。(因為停止運轉時也耗電。)
- ② Maintain the product as usual.
需進行維護保養。
- ③ Cover the product with a poly bag, and keep it in a dry place. (If you overturn it or keep it flat, product malfunctions may occur.)
蓋上塑膠袋並存放於乾爽處。(倒置或平放可能會導致產品發生故障。)

FURTHER INFORMATION

更多信息

About nanoe®

關於nanoe®

- nanoe® can be switched off. nanoe®功能可關閉。
During operation, press **Turbo Timer** and **Sleep (8 h)** buttons at the same time for about 3 seconds (nanoe® indicator lights off). Press the buttons for about 3 seconds again to restart the nanoe®. (nanoe® cannot be set during product stops operating.)
在產品運轉狀態下，同時按下 **Turbo Timer** 和 **Sleep (8 h)** 按鈕約3秒(nanoe®指示燈熄滅)。再次按下約3秒，可重新開啟nanoe®功能。(產品停止運轉狀態下，nanoe®功能不能設置。)
- Conditions for nanoe® generation nanoe®產生的環境條件
nanoe® is generated by using the air in the room. Therefore, due to the differences in temperature and humidity nanoe® may not be generated stably.
Room temperature: about 5 °C~35 °C (dew-point temperature: 2 °C or above)
Relative humidity: about 30%~85%
利用室內空氣產生，根據溫度和濕度的不同，有時可能無法穩定產生。
室內溫度：約5 °C~35 °C (露點溫度：2 °C以上) 相對濕度：約30%~85%
- When nanoe® is generated, small amount of ozone will be released. However, the quantity will be far less than the level in natural environment such as forest, and not be harmful to human beings.
產生nanoe®的同時，也會產生微量臭氧。但其產生量遠遠不及森林等自然界存在的臭氧量，不會對人體造成傷害。

About HEPA composite filter 關於HEPA多功能過濾網

The HEPA composite filter which with the Bio-sterilization and Super Allergy-buster can inhibit allergens (pollen, dead mites and feces), bacteria, mold.

HEPA多功能過濾網中集成了生物除菌、抗過敏原，能夠抑制過敏原（花粉、蟎蟲屍體及糞便）、細菌、霉菌。

- Super Allergy-buster: inhibits the activity of allergic substances (pollen, dead mites and feces).

抗過敏原：抑制過敏原（花粉、蟎蟲屍體及糞便）的活動。

Testing authority: Osaka Municipal Technical Research Institute

檢測機構：大阪市立工業研究所

Test method: check the decrease of refined house dust mite allergen, by using enzyme immune measuring method.

檢測方法：通過酶免疫測定法，確認精製塵蟎過敏原的降低。

Inhibiting method: contact with Super Allergy-buster

去除方法：與抗過敏原接觸

Target: allergens trapped by the filter (mites, pollen)

檢測對象：過濾網收集的過敏原（蟎蟲、花粉）

Test result: inhibited 99% and above. (Daikou research report No. 2127)

檢測結果：抑制99%以上。（大工研報第2127號）

- The HEPA composite filter might emit unique and harmless smell of "Green Tea Catechin", "Bio-sterilization" and "Super Allergy-buster".

HEPA多功能過濾網會散發出“綠茶兒茶素”、“生物除菌”以及“抗過敏原”特有的氣味，此氣味對人體無害。

FURTHER INFORMATION

更多信息

About odor sensor 關於異味感應器

The sensor can detect the pollution of the air, and show the pollution level by indicator. The product can optimize the air volume automatically in auto operation according to the air quality. 檢測空氣污染物，通過指示燈顯示污染程度。在風量為自動時，根據空氣污染狀況自動調節風量淨化空氣。

Sensor 感應器	Sensing scope 感應範圍	May detect 有可能感應
Odor sensor 異味感應器	<ul style="list-style-type: none">• Odor from cigarettes, incense, cooking, pets 香煙、香燭、烹飪、寵物的氣味• Cosmetics, alcohol, sprays, etc. 化妝品、酒精、噴霧劑類等	<ul style="list-style-type: none">• Humidity (water vapor), oil 蒸汽 (水蒸汽)、油煙• The wind generated when a door is opened or closed, or sudden temperature changes 開關門時產生的風或急劇的溫度變化等

■ The sensor's operation may vary depending on the indoor airflow condition if a heater is placed near the product in a room. 在靠近加熱器的場所使用時因室內空氣的流動，感應器的工作狀況有可能會發生變化。

■ The sensor is not designed to detect bacteria and viruses. 不能夠感應細菌以及病毒。

■ The sensitivity of the sensor can be adjusted. (The default setting is "medium sensitivity" .) 感應器的靈敏度可調節。(出廠設置為“中感應度”)

① Stop operating the product, then press **Turbo Timer** and **Air Volume** buttons at the same time for about 3 seconds. The air volume indicator will light on sequentially.

產品停止運轉的狀態下，同時按下 **Turbo Timer** 和 **Air Volume** 按鈕約3秒，風量指示燈依次點亮。

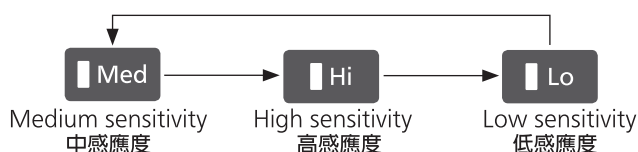

② Please release the buttons, when the sensitivity is set as required.

達到所需設置模式時，請鬆開按鈕。

FAQ

常見問題解答

Please confirm the following before you put questions forward or send the product for repair.
諮詢或送去維修之前，請先確認以下情況。

Q1

Why is a “jee” sound from the emission outlet?

為什麼出風口發出“噠”的聲音？

A

There is a slight sound when nanoe® is being generated. Depends on the environment and operation mode, the sound may be a bit loud or inaudible but it is not abnormal.
產生nanoe®時，將發出些許聲音。根據使用環境、運轉模式不同，聲音的大小有所不同，這並非異常。

Q2

Why does the clean sign remain red even when the operation continues?

即使是持續運轉，空氣污染度指示燈一直為“紅色”

A

The indicator may illuminate red when the product is subject to steam or vapor emitting from sprayers.

受到浴室等熱氣、噴霧產生的氣體影響，指示燈可能會變紅。

Q3

Why does the clean sign remain blue even when the air is dirty?

空氣有污濁，但空氣污染度指示燈顯示仍為“藍色”

A

Is the product placed in area where the dirty air is difficult to be cleared or the room size is too large for the product? (P. 5, back cover)

請確認產品是否在污染物難以吸入機體或面積太大的場所使用？(第5頁、末頁)

Q4

How to turn off the clean sign?

怎麼關閉空氣污染度指示燈？

A

■ Please press **Sleep (8 h)** and **Air Volume** buttons at the same time for about 3 seconds during operation.

在運轉過程中同時按下 **Sleep (8 h)** 和 **Air Volume** 按鈕約3秒鐘。

■ Please press the buttons for about 3 seconds again to relight clean sign.

再次按此按鈕約3秒，可重新點亮空氣污染度指示燈。

TROUBLESHOOTING

故障排除

If a problem is encountered, please investigate it by going through the following items.
If the problem still persists, please disconnect the power and contact the dealer for repair.
首先請確認以下內容，如果仍無法修復，請拔出電源插頭，聯繫經銷商進行維修。

Possible situation 可能發生的狀況	Please confirm the following 請確認以下內容
① Polluted air is difficult to be removed 難以去除空氣中的污物	<p>■ Is the HEPA composite filter dirty? (P.14) → Please clean it. If the situation persists, replace the filter with a new one. HEPA多功能過濾網是否髒污？（第14頁） → 維護保養後仍然無改善時，則更換新的過濾網。</p>
② The air volume is small 出風量少	
③ The odor from the product is unpleasant 產品的氣味讓人感覺不適	<p>■ Is the body, front panel or filter dirty? (P.14) → If the problem persists after the filter is cleaned, please replace it with a new one. (The harmful carbon monoxide generated by cigarette cannot be removed) 機體、前面板、過濾網是否髒污？（第14頁） → 如果清潔後仍無改善，則更換新的過濾網。 (本產品不能去除香煙中的一氧化碳。)</p> <p>■ Has the product ever been used in a room with strong odor? If the product is used in a room with strong odor such as aromatic smell, cigarette smoke or barbecue smell, the filter replacement period may be shortened. → If you use the product in such environments, it is recommended to open the air ventilation system or open the windows to ventilate the room at the same time. 在濃烈氣味的房間內使用過嗎？如果在有芳香劑、香煙、烤肉或濃烈氣味場所中使用，可能會縮短過濾網的使用週期。 → 在這種環境下使用時，建議同時打開房間的換氣系統或適當開窗通風。</p>
④ The sensor sensitivity can not be set up 無法設定感應器的靈敏度	<p>■ Is the product turned on? Sensor sensitivity can not be set up unless the product turned off. 產品是否在運轉？ 靈敏度的設定只能在產品停止運轉的狀態下進行。</p>

If any of the following cases occur, please contact the dealer immediately for repair.
如遇以下情況，請立即聯繫經銷商進行維修。

All the air volume indicators are blinking 風量指示燈全部燈閃爍	<p>■ Product may be out of order. → Please disconnect the power and contact the dealer for repair. 產品可能發生故障。 → 請拔出電源插頭，聯繫經銷商進行維修。</p>
--	---

SPECIFICATIONS

規格

Model number 型號	F-PXM35H		
Power supply 額定電壓・頻率	220 V~ 50 Hz		
Air volume settings 風量模式	Hi	Med	Lo
Power consumption (W) ^{*1} 消耗功率 (W) ^{*1}	24	9	6
Air volume (m ³ /min) 風量 (m ³ /min)	3.5	2.0	1.0
Floor area capacity ^{*2} 適用面積 ^{*2}	Up to 26 m ² in a standard household room 普通家庭，最大適用面積26 m ²		
Power cord length 電源線長度	2.0 m		
Product dimension 產品尺寸	300 mm x 189 mm x 520 mm (WxDxH) 寬度300 mm X 深度189 mm X 高度520 mm		
Product weight 產品重量	4.8 kg		

※1 The power consumption is about 0.8 W when the operation is set to "Off".
(With the power plug inserted).

運轉狀態為“關”時的耗電量為0.8 W。(插上電源插頭的狀態)

※2 Floor area capacity is based on JEM1467, under the condition of Hi speed.
(Japan Electrical Manufacturers' Association)

適用面積依據JEM1467，在高速運轉的狀態下測定。(日本電機工業協會標準)

Note: This product cannot remove hazardous substances such as carbon monoxide from the cigarette smoke.

注：本產品不能去除香煙中的一氧化碳。

OPTIONAL ACCESSORIES

自選配件

● Replacement HEPA composite filter

更換用HEPA多功能過濾網

Part No.:

型號： F-ZXMP35Z



● Replacement deodorizing filter

更換用脫臭過濾網

Part No.:

型號： F-ZXFD35X



Please contact dealer 出現下列情況時，請聯繫經銷商進行維修

- All the air volume indicators are blinking.
Product may be out of order. Please disconnect the power and contact the dealer for repair.
- 風量指示燈閃爍。
產品可能發生故障。請拔出電源插頭，聯繫經銷商進行維修。

Panasonic Corporation

Web Site: <http://www.panasonic.com>

©Panasonic Corporation 2017

Issue date:09/2017

發行日期：09/2017

P0917-0

PXM3H8952 C