

# 台松電風扇-(F-35TMH)

材質：模造紙、12頁、裝訂式

尺寸：寬183mmx高261mm

顏色：PANTONE 293C



負離子釋放設計榮獲台灣  
新型專利第 169399 號

Negative ion design has acquired the  
Taiwan's Utility Model patent No. 169699

# Panasonic®

## 使用說明書

Operating Instructions

## DC直流電風扇

### DC fan

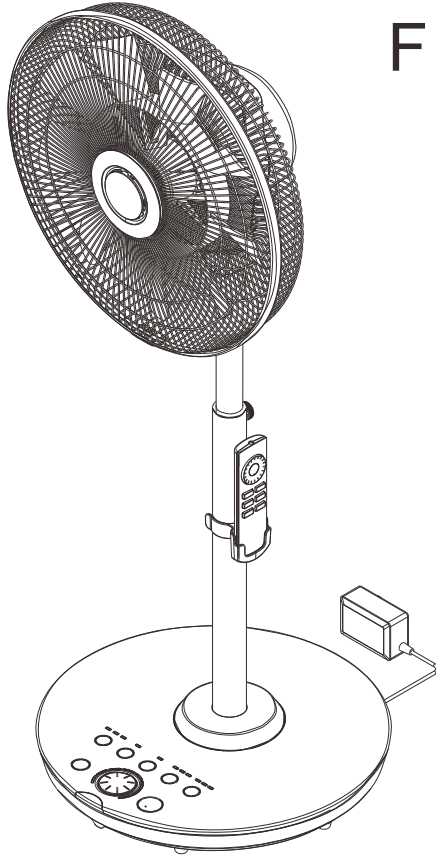

# F-35TMH

正確的使用，將幫助您更省電

另附保證書

Correct use will help to save power

Attached warranty card

在此誠摯地感謝您購買本Panasonic產品。

- 請於使用前，詳細參閱本使用說明書，正確使用，並妥善保存。
- 為確保您的權益，務必請經銷商在保證書上記入購買日期及經銷商名稱等。

Thank you for purchasing Panasonic product.

- Before operating this product, please read the instructions carefully, and save this manual for future use.
- To ensure your rights, be sure to ask the dealer to write the date of purchase and the name of dealer, etc on the warranty card.

目錄 頁號

安全注意事項 (請務必遵守).....	2~5	使用之前
各部名稱及組裝方法.....	6~9	

使用方法.....	10~13	使用方法
保養及收納.....	14	

緊急處理方法.....	15~16	遇到困難時
廢電器處理方法.....	15~16	
規格.....	15~16	
售後服務據點一覽表.....	封底	

Contents Page

Safety precautions (Please always follow these instructions).....	2~5	Before use
Name of parts and how to assemble.....	6~9	

How to use.....	10~13	How to use
Cleaning and storing.....	14	

Emergency handling.....	15~16	Troubleshooting
Recycling.....	15~16	
Specifications.....	15~16	
Service center.....	Back cover	

元山科技工業(股)公司/高雄研發處/說明書資料

客戶	台松	型號	F-35TMH
機型	電風扇	製表	許淮棋
材質	模造紙、16頁、裝訂式	日期	103.09.05
料號	PFH14BND02A	備註	

(2) 研發

# 安全注意事項

請務必遵守

以下說明是為防範使用者或使用時危及他人之性命、財產安全的注意事項，請您務必遵守。

■如果您無視於圖示內容而不當使用所發生的危害或損傷程度，有可能如下列之標示內容。



**警告**

有此標示的內容為「設想可能導致死亡或重傷」。



**注意**

有此標示的內容為「可能引起傷害或導致物品的損傷」。

■請您務必遵守下列圖示內容並區分加以說明。（以下圖示僅是一個例子）。



有此標示，表示為「禁止」的事項。



有此標示為確實請您執行的「強制」事項。

## 警告

■絕對不要私自分解、修理或改造機器。



禁止分解

常會因而引發起火，或因不當使用而引起火災或觸電、受傷。

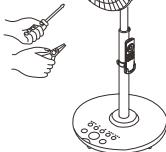

●需要修理時，請洽詢直屬服務站或經銷商。

■請使用專屬的電源供應器，切勿更換其他電源供應器，避免造成機器損壞。



●可能造成火災或觸電。

●（如需更換電源供應器，請洽詢直屬服務站或經銷商。）

■在沒有裝上扇葉及護網時請勿開電風扇。



禁止 易造成傷害。

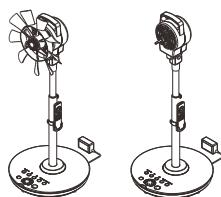

■在組裝上、收藏時如未組裝上扇葉或護網，請勿旋鬆高度調整螺絲。



禁止

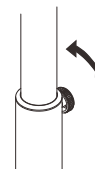

恐馬達部份或伸縮桿飛出來而傷到人。

■確定電源供應器的插頭確實插在插座上。

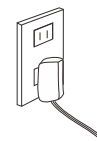

●可能因發熱造成火災或觸電。

●如插頭有損傷或鬆脫，請勿再使用。

■請勿潑到水或浸在水中。



禁止 容易因短路而引起火災或觸電。



# Safety precautions

Please always follow these instructions

To avoid the possibility of causing injury to users or damage to properties, please follow all the explanations written below.

■ The following symbols differentiate the levels of danger and injury that may result if you ignore the illustrated content and improper use.



**WARNING**

This symbol indicates improper handling may cause a risk of death or serious injury.



**CAUTION**

This symbol indicates improper handling may cause a risk of injury or damage to properties.

■ The following symbols indicate type of instructions to be observed. (The symbols given below are examples.)



This symbol denotes an action that is PROHIBITED.



This symbol denotes a COMPULSORY action.

## WARNING

■ **Never try to take apart, repair or modify this product.**



Taking apart is prohibited

Improper use usually cause electric shock, fire and injury.

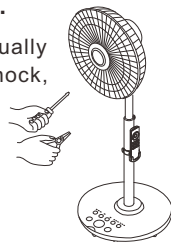

● Contact the service center or dealer for repairing this product.

■ **Always use with the supplied AC adaptor, do not exchange to other AC adaptor in order to avoid damage of the product.**



● May occur and cause fire or electric shock.  
● If need to replace AC adaptor, please contact the service center or dealer.

■ **Please do not turn on the product unless blade and guard are installed properly.**



Prohibit

It's easy to cause injury.

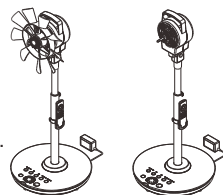

■ **When assembling or storing, do not press the height adjustment screw unless blade and guard are installed properly.**



Prohibit

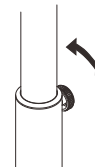

Motor unit and slide pipe may come out rapidly and cause injury.

■ **Make sure the power plug of AC adaptor is fully inserted into socket.**

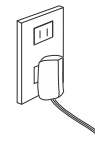

● May cause fire or electric shock due to overheat.  
● Do not use the damage plug or loosen socket.

■ **Do not immerse the product in water, or put water on it.**



Prohibit

It's easy to cause short circuit and occur fire and electric shock.



## 警告

■請勿損壞電源線及插頭。請勿將電源線損傷、加工、接近電熱產品、強加扭曲、折疊、拉扯、以重物壓迫、緊束。



禁止



如受損後仍強加使用的話，常會引起觸電、漏電，恐引起火災。

■請勿以潮濕的手碰觸插頭。



禁止

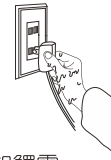

恐引起觸電。

■在保養或收納產品時，請先將插頭拔離。



拔電源插頭

由於不經意的操作可能引發傷害或觸電。



■請定期清除插頭上的塵垢。



插頭可能因為積塵或濕氣等原因而使絕緣性不佳，引發火災。

- 請將插頭拔離，並以乾布擦拭。
- 除了在使用中，否則請將插頭拔離。

## 注意

■請勿在以下場所使用。  
●瓦斯筒或有火的附近，或有引火性瓦斯的場所。



禁止



可能因火苗而引火、爆炸或短路，而引起火災、觸電。

■請勿長時間對著身體吹風。



禁止

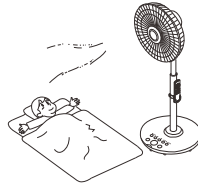

可能對健康有害。

■請勿放置於障礙物的周圍或不安全的場所中使用。



禁止

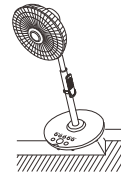

可能使之翻倒或造成傷害。

■請勿將手指伸入護網或可動部位中。



接觸禁止

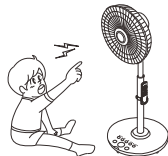

可能造成傷害。

■拔除插頭時，請手握住插頭請勿拉扯電線。



可能使電線短路或斷線，而造成火災或觸電。



### 注意

- 若電源線損壞時，請諮詢直屬服務站或經銷商，由專業人員更換，以避免危險。
- 請勿連接電壓調節器(調光器)來使用本產品，以免造成危險。
- 此機不適合傷殘人士、知覺障礙人士、智力障礙人士或缺乏機械操作經驗及知識之人士(包括兒童)自行操作，如有安全負責人在場監督及提供指導下協助操作此機，則屬例外。
- 請勿讓兒童擅自操作此電風扇。

4 (提醒) 請勿噴灑殺蟲劑等物品，或在有使用油或藥品的場所使用之。(恐造成產品的變質或損傷)。

## ! WARNING

- Do not cut, modify. Do not forcefully bend, twist or pull. Do not put near heating appliances, or put anything heavy on. Do not bundle.



Prohibit

If damaged power cord or plug is used, it's easy to cause electric leakage, electric shock and occur fire.

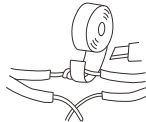

- Do not touch the plug with wet hands.



Prohibit

It may cause electric shock.

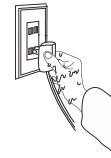

- Make sure to disconnect the plug when cleaning and storing away the product.



Disconnect the power plug

Improper operating may cause injury or electric shock.

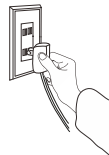

- Wipe off dust on the power plug periodically.



If the plug is used with dust accumulated on it, humid air etc. may cause poor insulation and fire.

- Disconnect the plug and wipe it with a dry cloth.
- Disconnect the plug unless the product is been using.



Before use

## ! CAUTION

- Do not use the product at the following locations.

- Where it maybe exposed to flammable gas or near sources of flame such as gas ranges.



Prohibit

Flame failure, catching fire, explosion, short circuit, etc. may occur and cause electric shock of fire.



Prohibit

It may cause health related issue.

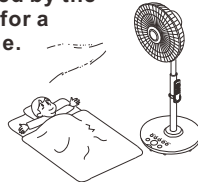

- Do not use the product near the obstacles or unsafe place.



Prohibit

The product may fall down and cause injury.

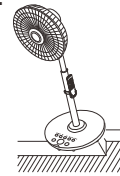

- Do not put your fingers into the guard or any moving part of the product.



Do not touch

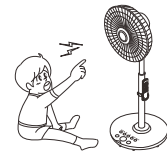

It may cause injury.

- When disconnecting the plug, please grasp and pull the plug, not the cord.



It may cause short circuit or damage the power cord, and occur fire or electric shock.



### ! CAUTION

- If the power cord damaged, please contact the service center or dealer. Exchange by professional in order to avoid danger.
- When using the product, do not connect with voltage regulator in order to avoid danger.
- This appliance is not intended for use by persons (including children) with reduced physical, sensory or mental capabilities, or lack of experiences and knowledge, unless they have been given supervision or instruction concerning use of the appliance by a person responsible for their safety.
- Do not operate this product by children.

**Reminder** : Do not place the product near insecticide, oil corrosive solvent.  
(It may cause bad effects on quality, or damage the product.)

# 各部名稱

## Name of parts

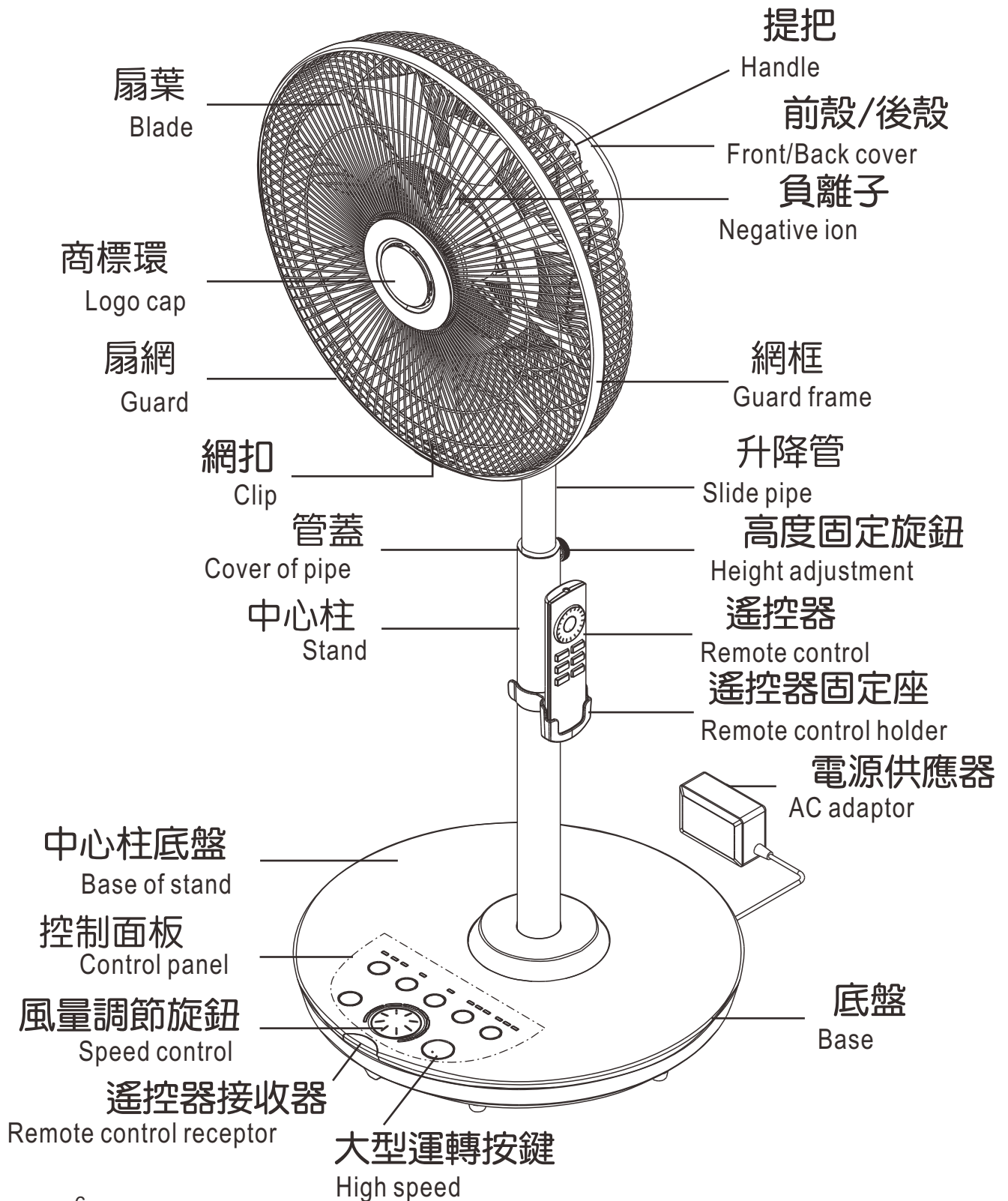

# 組裝方法

## 底盤組裝

1. 將中心柱螺帽自中心柱取下後，將機體之中心柱裝入底盤。
2. 再以中心柱螺帽自底盤底部鎖付旋緊。
3. 插入電源供應器接頭，調整線長再將電線放入整線溝槽，蓋上電源盒蓋即完成底盤組裝。

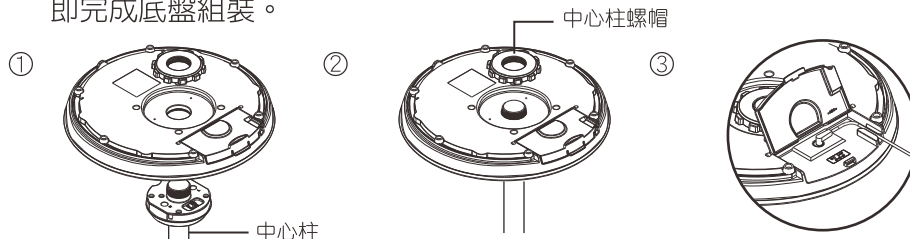

提醒：為避免使用中鬆脫，請確實將中心柱螺帽旋緊。

## 扇葉組裝

請依下列順序正確組合後再使用

### 1 將葉束、馬達轉軸塑膠套、網束取出

請將塑膠套保存起來，以方便日後收藏時之用。

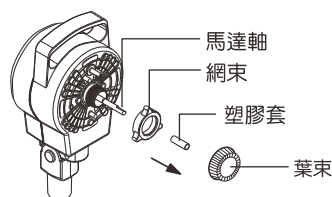

### 2 套上後網用網束旋緊

後網3個缺口對準馬達前蓋凸出3個小柱將後網緊貼馬達後，以網束套上並向右鎖緊（順時針方向）。（後網箭頭朝上）



**警告**  
組裝時請勿觸碰負離子放電針，以免尖銳傷人。

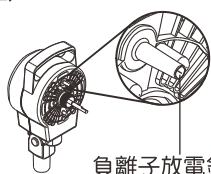

### 3 裝上扇葉

將扇葉插入馬達轉軸後緊貼，再以葉束旋緊（逆時針方向）。

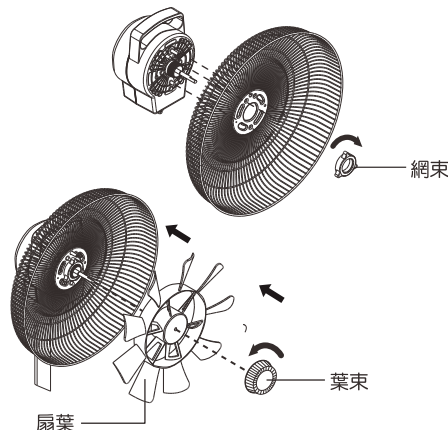

### 4 前網安裝

- 將前護網之網框箭頭指示處對準後護網紅色記號。
- 前、後護網相互嵌合，確實密合夾好。
- 將網扣確實向後壓入。
- 本機台屬於雙重絕緣，為了確保您的安全，請務必將網扣確實組裝定位。

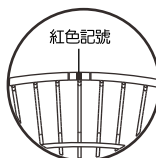

後護網壓扣位置

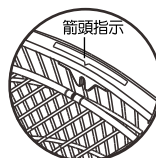

前護網箭頭指示處確實嵌入紅色記號



- 提醒：
- 各部份鎖付位置請確實旋緊，組裝完成，以免馬達轉動造成扇葉飛出的危險。
  - 本機台屬於雙重絕緣，為了確保您的安全，請務必將護網組裝完成，網扣確實壓入，才可操作。
  - 若前、後網未確實依指示方式嵌合，可能產生電荷蓄積現象，導致負離子無法正常釋放，請務必確實將前、後網嵌合固定。

# How to assemble

## Installing the base

1. Remove the nut from the stand, and insert the stand into the base.
2. Tighten the nut from the bottom of base to secure the stand to the base.
3. Insert the connection plug of the AC adaptor, fix the power cord into the clip, and then close the cover to finish the assemble.

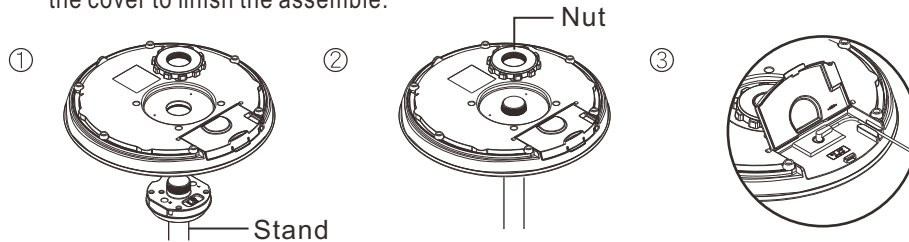

Reminder: Tighten the nut securely, not to be loosened.

## Installing the blade

Please follow the step order and install correctly before use

### 1 Remove the spinner, cap and guard stopper nut.

Please keep the plastic bag for future store.

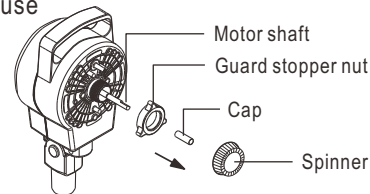

### 2 Fix the rear guard to the motor and then tighten the guard stopper nut securely

Align each of 3 holes and 3 projections, then fix the rear guard to the motor, tighten the guard stopper nut securely (clockwise direction). (marks the arrowhead of the rear guard points up)

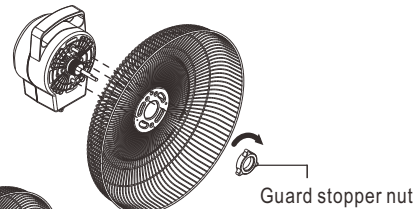

#### ⚠ Warning

Do not touch the negative ion emission device when installing to avoid injury.

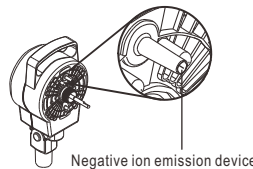

### 3 Installing blade

Insert the blade into the motor shaft closely, then tighten with spinner securely. (counter clockwise direction)

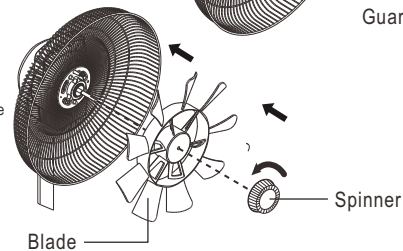

### 4 Installing the front guard

- Align the arrowhead of the front guard and the red mark of the rear guard, and insert the hook to the wire rod fully.
- Engage the clip to fix the front and rear guard.
- Engage the clip press backward.
- This product belongs to double insulation, in order to ensure your safety, please assemble the clip completely.

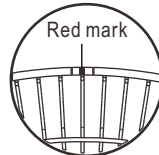

Rear guard clip press place



Front guard arrowhead mark, make sure to insert into red mark

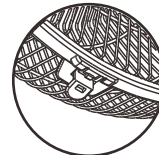

Make sure the clip presses backward

Reminder: • Tighten every part securely to avoid the blade from coming out during the operation.

- This product belongs to double insulation, in order to ensure your safety, please assemble the guard completely, make sure the clip presses in, then can start the operation.
- If the front guard and the rear guard are not assembled as instruction, it may cause electric charge accumulating phenomena and stop the negative ion from releasing normally. Please make sure the front guard and the rear guard are assembled correctly.



### 高度升降調整 Height adjustment

旋鬆升降管調整螺絲，將升降管作高度之適當調節至合適位置，再將升降管調整螺絲旋緊即可。

Loose the adjustment nut of slide pipe, adjust the height of slide pipe to an appropriate position, then tight the adjustment nut of slide pipe.

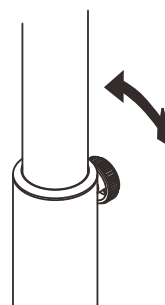

### 遙控器收納 Remote control holder

將遙控器座固定於中心柱。

Fix the remote control holder on the stand.

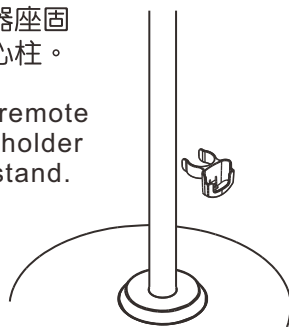

遙控器可收納於遙控器座。

Remote control can be stored in the remote control holder.

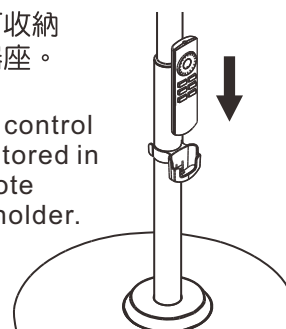

### 風向調節 Swing (Oscillation)

於自動擺頭或朝單一方向吹送時，均可作手動調整吹送方向至需要之方向，以改變其吹送風方向。

Whether during the Auto swing mode or not, the wind direction can be adjusted by hand.

左右調整  
Horizontal swing

可左右調整所需風向角度  
Adjust the desired angle by oscillating to left and right

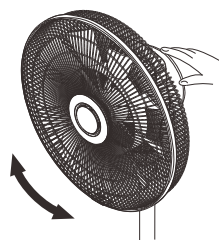

上下調整  
Vertical swing

可上下調整所需風向角度  
Adjust the desired angle by oscillating to up and down.

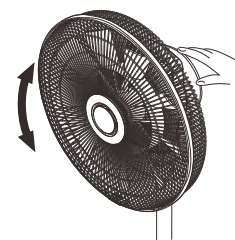

# 使用方法

## 遙控器的準備

- ① 電池蓋開啟：請輕壓後下推到底，在將其往上取出。

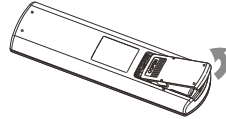
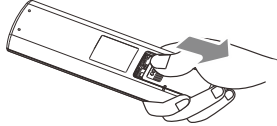

- ② 將電池裝上。  
2個R03單四型乾電池。

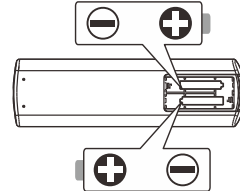

- ③ 電池蓋安裝：請單邊對準本體的○記號後，由上往下輕壓，嵌合後，前推到底。

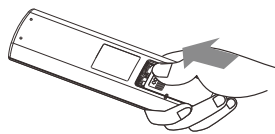
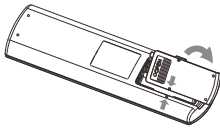

## 控制面板

### 「模式」控制鍵

每按一次「模式」鍵，則依下圖之順序切換模式。  
正常風 → 自然風 → 睡眠風

- 正常風：可轉動風量調節旋鈕，設定風量（正常風顯示燈亮）。
- 自然風：自動變換風量（自然風顯示燈亮）。
- 睡眠風：每小時遞減風量，直到最小風量（睡眠風顯示燈亮）。

### 「節能」控制鍵

每按一次「節能」鍵可切換ECO溫控功能的啟用或關閉。節能功能啟用後，風量與模式指示燈熄滅。

- ECO溫控：可偵測環境溫度，自動調整風量（ECO溫控顯示燈亮）。

正常風 自然風 睡眠風  
模式



ECO溫控  
節能



### 「擺頭」控制鍵

每按一次「擺頭」鍵可切換左右擺頭或擺頭停止。



Panasonic

10N清淨  
負離子



1 2 4 小時  
定時關機

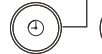

4 6 8 小時  
預約開機



### 「預約開機」控制鍵

每按一次「預約開機」鍵，則依下圖之順序設定開機時間，並亮該燈。  
4 → 6 → 8(小時) → 燈滅

可預設模式與風量，到達預約時間自動開機。

- 在開機狀態下，選擇所需模式、風量後，設定預約開機鍵，約5秒後進入預約開機模式，此時風扇停止運轉，並進入倒數計時；至所設定時間終了時，風扇開始運轉。

### 「風量調節」旋鈕

- 轉動旋鈕，順時鐘方向可增強風量，逆時鐘方向可減弱風量。
- 八段風量指示燈，顯示風量大小。
- 在(自然風)模式，調節風量會自動切換到(正常風)模式。

### 「運轉 關/開」鍵

- 按下此鍵可切換運轉或是停止。
- 插頭接電之後，按下電源鍵時，其最初的運轉將會是「正常」風(第四段)。
- 記憶功能：
- 停止運轉後再次按下電源鍵時，會以停止前的運轉模式啟動。但定時功能的时间無法記憶。
  - 一旦拔除電源後所有的記憶將會消除。

**提醒** 如尚未按下「運轉 關/開」鍵，是無法使用其他按鍵的。

# How to use

## Remote control

- ① Open the battery lid: press down and take it out.

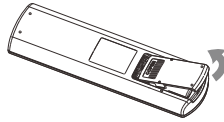
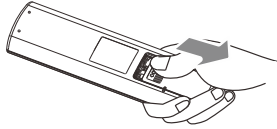

- ② Insert the battery.  
2pcs of AAA dry cell.

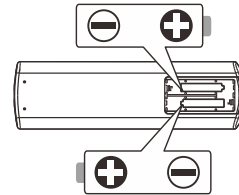

- ③ Close battery lid : Align the single side with mark O on the body, press and push to all the way in.

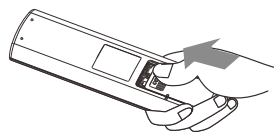
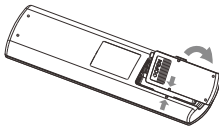

## Control Panel

### Mode button

Each press of the button will switch to next mode setting.

Normal mode → Nature mode → Sleep mode

- Normal mode: Speed could be adjusted by turning the adjustment. (Normal mode lamp would turn on)
- Nature mode: Speed will be switched to Auto mode. (Nature mode lamp would turn on)
- Sleep mode: Speed will be moderate in every one hour, until to the minimum speed. (Sleep mode lamp would turn on)

### ECO button

Each press of the button will switch to ECO Off / On setting. During ECO mode, the speed and mode instruction lamp would turn dim.

- ECO control: Speed will be adjusted according to the ambient temperature detected. (ECO lamp would be bright)

### Negative ion button

Each press of the button will switch to cleaning function Off / On.

- ION: release negative ion to clean the air (ION lamp would turn on.)

### Off timer button

Each press of the button will set the turn off time by following step and the lamp would turn on.

1 → 2 → 4 Hour → Lamp turn off

The fan stops operation when the preset hours has passed.

- You can set Off and On timer simultaneously.  
When setting Off timer 1 hour and On timer 4 hours, the fan stops operation after 1 hour and resumes after stop operation 3 hours.

### On timer button

Each press of the button will set the turn on time by following chart and the lamp would turn on.

4 → 6 → 8 Hour → Lamp turn off

It could preset the mode and speed, the fan starts operation when the preset hours has passed.

- Under the operation On situation, choose mode and speed, then setting on timer, it would enter on timer mode after 5sec., the fans would stop the operation and count down until the setting time finished, then the fan resumes operation.

### Swing button

Each press of the button will switch to next angle setting.



### Speed adjustment button

- Turn the adjustment in the clockwise direction could strengthen the speed, counter clockwise of direction could moderate the speed.
- Eight level speed instruction lamp shows the level of speed.
- On (Nature) mode, adjust the speed adjustment would switch to (Normal) mode automatically.

### Power On/Off button

Each press of the button will switch to On / Off.

- When plug in and turn on, the fan starts operation at "Normal" speed. (the fourth level)
- Memory function:
  - When fan stops and press the on/off button, the fan starts operation at previous setting of mode, but timer setting will not be retained in memory.
  - When unplugged, memory will be deleted.

**Reminder** If the fan is not turn on, all of the buttons without function.

## 遙控器的準備

### 遙控器各部名稱

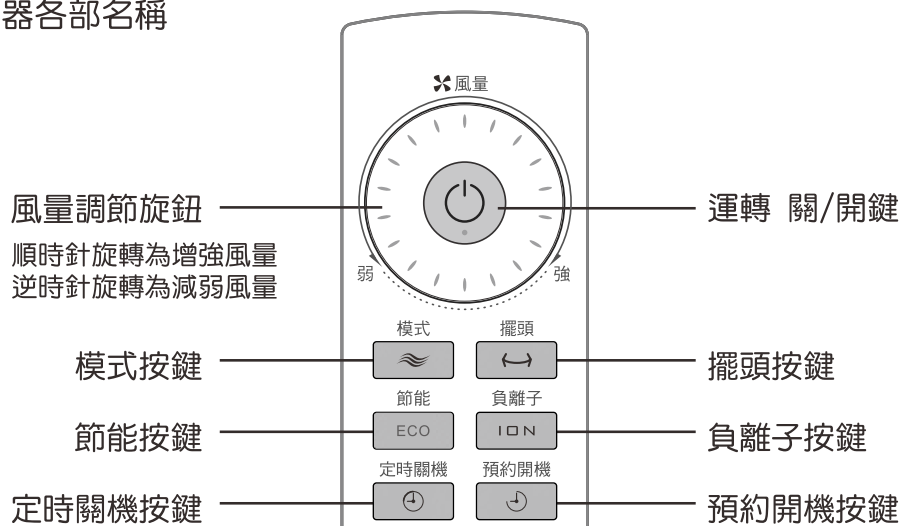

### ■ 遙控器的使用方法

1. 遙控器發信部須朝接收器（機體）。  
操作可能距離約4.5m，左右兩邊在25度以內的範圍
2. 注意避免有物品擋住信號發射。

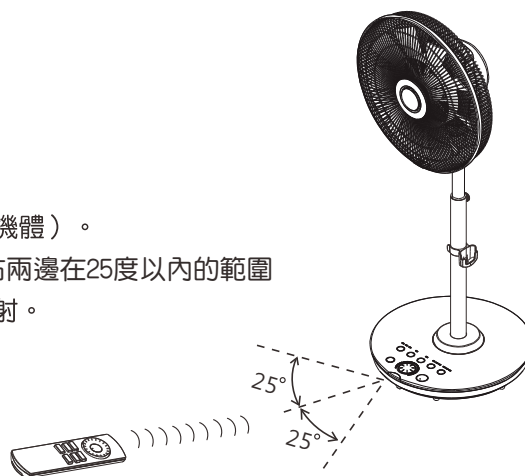

### 提醒

- 本產品設計逆插防止裝置，若發現電池無法完全置入盒內或電池蓋無法順利推入，即是電池⊕⊖極錯誤，請重新安裝電池。
- 若操作遙控器時控制面板上之操作指示燈沒亮，請重新裝新電池。

備註：  廢電池請回收

### 遵守事項

- 有關遙控器使用：
  - 請避免遙控器的扔投、掉落或浸水。
  - 不要在會妨礙信號傳送的地方使用，如窗簾、屏風等。
  - 於使用前務必事先瞭解操作方式，請詳細讀後再使用。
  - 太陽不會直接照射到的地方。
  - 遠離火爐的地方。

## Preparation of remote control

Name of parts for remote control

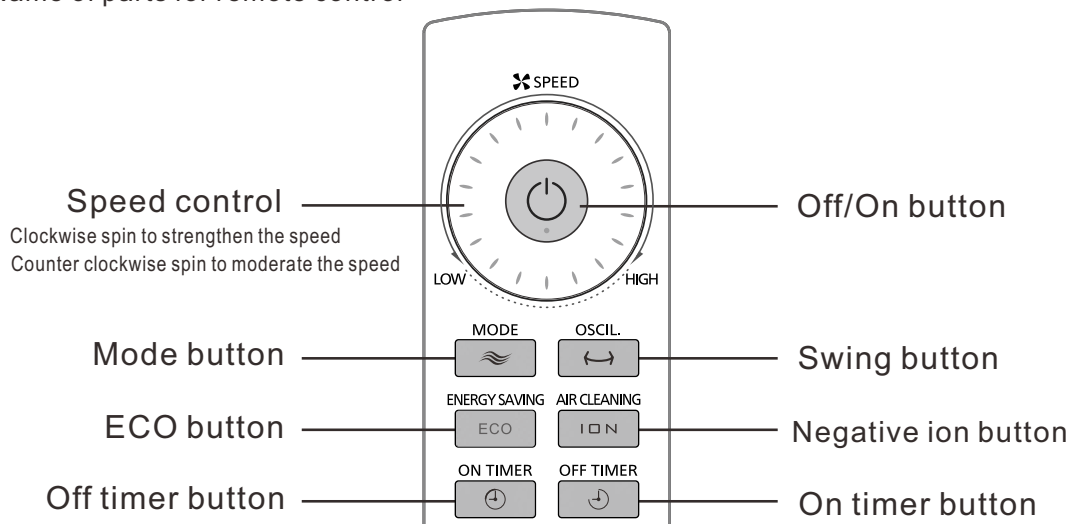

### How to use the remote control

1. Point the remote control transmitter in the direction of the receptor.  
The controllable distance is about 4.5m from the receptor and 25 degree angle to the right and left.
2. Do not cover up the receptor.  
It prevents the remote control from functioning.

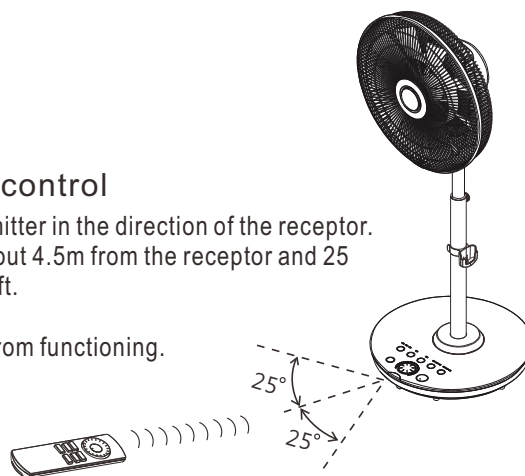

#### Reminder

- The remote control was designed to prevent reverse battery, when the batteries were inserted in the reverse direction (⊕⊖), the battery will not fit into the remote control and battery lid can not be closed, thus check and place the battery in the correct direction.
- When operate the remote control, if the operation lamp on the control panel is not bright, please replace the batteries.

Remarks: Please recycle the waste batteries.

#### Follow items

- **Remote control use:**
  - Do not use in where could block the signal release, such as window curtains, screen.
  - Do not exposure to sun directly.
  - Keep away from stove.
- Do not throw, fall or dip in water the remote control.
- Before use the remote control, please read the instruction carefully and clear the operation measures.

# 保養及收納

## Cleaning and storing



**警告**

在保養本機器時，請先關機、並拔掉插頭。

由於不經意的操作可能引發傷害或觸電。

擦拭時請勿潑水

容易因短路而引起火災或觸電。



**WARNING**

Make sure to disconnect the plug when assembling, cleaning and storing away the product. The product may start operating unexpectedly and cause injury or electric shock.

Do not immerse the product in water or put water on it when wiping.

Short circuit may occur and cause electric shock and fire.

### 提醒

- 在購買本商品超過3年以上，電源供應器可能會有損傷或積塵等引起各種無法預測的損害。為了延長機械的使用年限，請定期將機器送至直屬服務站或經銷商檢查。

### Reminder

- Purchasing this product over 3 years, the AC adaptor may have damages or dust etc. and cause any kinds of unexpected injury. In order to extend the product life time, please regularly check the product to the service center or dealer.

- 為防止觸電危險，保養時請先將插頭拔起。
1. Make sure to disconnect the plug when assembling, cleaning and storing away the product.

- 為了增加機器效率及安全，請定期保養清潔後殼散熱孔。（約一月一回）
2. Please clean regularly the ventilation hole at the rear case in order to maintain the efficiency and safety of the product. (about once a month)

- 前網、扇葉、後網拆裝保養或清潔時，請依組立時反順序拆下。
3. To maintain or clean front guard, blade and rear guard, please disassembling in the reverse step order.

- 扇葉、本體等保養，請使用軟布沾溫水或中性清潔劑擦拭乾淨後然後再用乾布擦乾。

- 絕對禁止使用揮發性溶劑（汽油、香蕉水...）、鹼性肥皂水、熱水等來擦拭機體以免造成塑膠或塗裝部品受損、變質。
4. To clean the blade, body, etc., please use soft cloth soaked in warm water with or without detergent. Wipe with dry cloth. Do not use thinner, benzine, alcohol cleaning powder, alkaline detergent, etc.

- 馬達軸擦拭乾淨後，為防止生鏽，請使用潤滑油塗在上面並套上塑膠套，且儲存於濕氣少的地方。
5. To prevent motor shaft from rusting, please wipe clean, apply lubricant, put the cap back in, and store in dry area.

- 收納
- 不使用時，請按原組裝步驟，反方向拆卸收好，放回原包裝箱，置於乾燥陰涼處。

- Storing away
- To store away, please disassemble the fan in the reverse step order instruction, place inside the original package, and stored in the dry area.

- 警告** 收納時請勿觸碰負離子放電針，以免尖銳傷人。

- WARNING** Do not touch the negative ion emission device, in order to avoid the injury cause by sharp pin.

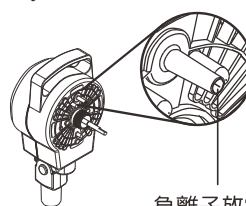
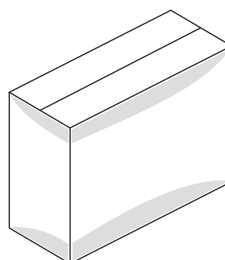
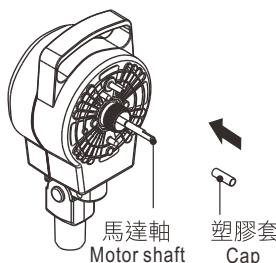
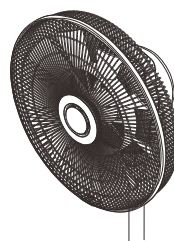
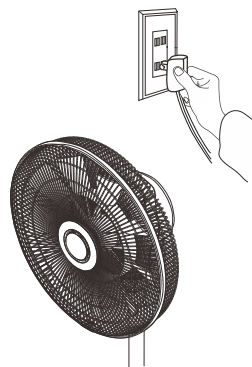

負離子放電針  
Negative ion emission device

# 緊急處理方法

## 警告

- 發生異常時（燒焦味等）須停止運轉功能，拔掉電源插頭。  
在異常狀態下繼續運轉，會因發熱引起火災，或觸電情況產生。  
請洽詢直屬服務站或經銷商。
- 請勿自行進行修理工作或更換電源線。  
修理不善是引起火災及觸電發生的原因。  
請洽詢直屬服務站或經銷商。
- 若電源線損壞時，請洽詢直屬服務站或經銷商，由專業人員更換，以避免危險。

## 規格

額定消耗功率為「強」時的數值。

型號	額定電壓 (V)	額定頻率 (Hz)	額定消耗功率 (W)	重量 (kg)	外型尺寸 (mm)
F-35TMH	220~240	50	22	5.6	長400x寬420x高900~1100

電源插頭未拔除，風扇未運轉時約耗電1 W以下！

### 愛情點檢

請為長年累月使用的電風扇檢查檢查吧！

有無這樣的現象呢？

- 有時已按下開關，卻無法運轉。
- 扇葉轉動緩慢，或轉動不規則。
- 馬達部份異常發熱。

如有這些狀況，為避免發生意外，請先關掉開關、將電源插頭拔離插座，並請洽詢直屬服務站或經銷商。

# Emergency Handling



- When a failure or malfunction occurs, stop using the product immediately and disconnect AC adaptor. Heat generation etc. may occur and cause electric shock or fire. (Examples of failure/malfunction)
    - Although connecting to power supply and turning on, the fan does not operate.
    - Abnormal noise is observed during operation.
    - Moving the power cord stops operation.
    - Blade rotates slowly, or irregularly.
    - Burning smell is observed.
    - Motor unit, AC adaptor or power cord becomes abnormally hot.
- Contact the dealer immediately for maintenance/repairing.

- Do not repair or replace the power cord. Improper repair usually cause fire and electric shock. Please contact the service center or dealer.
- If the power cord damaged, it must be replaced by the manufacturer, its service agent or similarly qualified persons in order to avoid a hazard.

# Specifications

The value under the rated power in strong status.

Model	Rated Voltage (V)	Rated Frequency (Hz)	Rated Power (W)	Weight (kg)	Dimension (mm)
F-35TMH	220~240	50	22	5.6	L400xW420x H900~1100

When power plug is unconnected and the product does not operate, the consumption power is below 1W!

## Diagnosis

Please check the fan which used over many years!

Does it have these situation?

- sometimes press the operation on button, but not working.
- The blade move slowly, or move irregularly.
- Motor shaft heating unusual.

If the product has these situation, in order to avoid the accident, please turn off and disconnect the power plug, contact the service center and dealer.