

Operating Instructions

IH Electronic Warm Jar Household Use

1.0 L model
Model No. **SR-FC108**

1.8 L model
Model No. **SR-FC188**



Illustrations of the SR-FC108 are used throughout this Operating Instructions.

- Thank you for purchasing this Panasonic product.
- This product is intended for household use only.
 - Please read the operating instructions carefully to ensure safe and correct operation before use.
 - Before use, be sure to read “Safety Precautions” (Pages 2–5).
 - Keep the operating instructions and the warranty for future use.

Warranty appended

Contents

Checks and Precautions	Safety Precautions	2
	Notes on Use	6
	Part Names/Accessories	7
Everyday Use	Cooking Rice	8
	Using the Programs Correctly	10
	Using Different Programs	11
	Cooking	12
	Keeping Warm	13
	● Keep Warm/Reheat	
	Using the Timer	14
	● When the current time is incorrect	
Recipes	● Congee/Casserole	15
	● Brown Rice/Grains	16
	● Cake/Steam	17
	Cleaning	18
Further Information	● When using for the first time & on every use	
	● Regular checks	
	● When the cleanliness of the Warm Jar is a concern	
	Does my Warm Jar have a fault?	20
	What does this mean?	21
	What to do when...	22
	Specifications	26

Safety Precautions

Please make sure to follow these instructions

In order to prevent accidents or injuries to the user, other people, and damage to property, please follow the instructions below.

■ The following charts indicate the degree of damage caused by wrong operation.

 **WARNING:** Indicates serious injury or death.

 **CAUTION:** Indicates risk of injury or property damage.

■ The symbols are classified and explained as follows:

 This symbol indicates prohibition.

 This symbol indicates requirement that must be followed.

WARNING

 ● Do not use the appliance if the power cord or power plug is damaged or the power plug is loosely connected to the power outlet.
(It may cause an electric shock, or fire caused by short circuit.)
→ If the supply cord is damaged, it must be replaced by a special cord or assembly available from the manufacturer or its service agent.

● Do not damage the power cord or power plug.
• The following actions are strictly prohibited.
Damaging, modifying, touching on or placing near heating elements, forcefully bending, twisting, pulling, pulled over sharp edges, putting heavy objects on top, bundling, pinching the power cord and carrying the appliance by the power cord.
(It may cause a fire or electric shock due to damage to the power cord or power plug.)

● Do not plug or unplug the power plug with wet hands.
• Always ensure that hands are dry before handling the power plug or switching on the appliance.
(It may cause an electric shock or injury.)

● Do not insert any object in the Intake Vent, Exhaust Vent or gaps.
• Especially metal objects such as pins or wires.
(It may cause an electric shock, or injury caused by malfunction.)

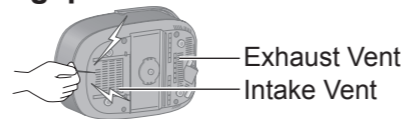

● Do not wash the main body with water, immerse the appliance in water or splash it with water.
(It may cause an electric shock, or fire caused by short circuit.)
→ Please contact an authorised dealer if water gets inside the appliance.



● Do not modify, disassemble, or repair the appliance.
(It may cause a fire, electric shock or injury.)
→ Please contact an authorised dealer for a repair.

WARNING

 ● Do not use the appliance for any purpose other than those described in these instructions.
(It may cause a fire, burn, injury or electric shock.)
• Panasonic will not accept any liability if the appliance is subject to improper use, or failure to comply with these instructions.

● Do not expose your face close to the Steam Vent or the Steam Cap or touch them with your hand while cooking or immediately after cooking.
• Pay extra attention to infants.
(It may cause a burn.)

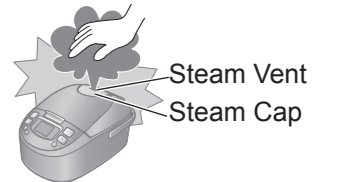

● Do not put anything in the Inner Pan to block the hole in the Inner Lid.
(Steam may leak or cooking contents may jet out, causing a burn or injury.)
<Examples of prohibited cooking methods>
• Cooking with the ingredients or seasoning in a plastic bag.
• Cooking by using aluminium foil etc. to cover the ingredients directly.

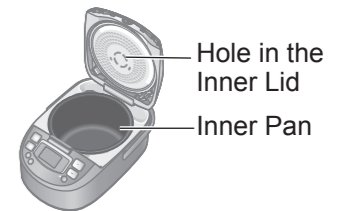

● Do not open the Outer Lid or carry the appliance while cooking.
(Steam may leak or cooking contents may jet out, causing a burn or injury.)

● Do not spill water or other liquid on the connector such as the instrument plug.
(It may cause an electric shock, or fire caused by short circuit.)

● Do not let anyone lick the instrument plug.
• Pay extra attention to infants.
(It may cause an electric shock or injury.)

 ● This appliance is not intended for use by persons (including children) with reduced physical, sensory or mental capabilities, or lack of experience and knowledge, unless they have been given supervision or instruction concerning use of the appliance by a person responsible for their safety. Children should be supervised to ensure that they do not play with the appliance.
(It may cause a burn, injury or electric shock.)

● Use only a power outlet rated at 10 Amperes and alternating electric current at 220 Volts.
(Plugging other devices into the same outlet may cause electric overheating, which may cause a fire.)
• Use only an extended cord rated at 10 amperes at least.

● Insert the instrument plug and the power plug completely.
(It may cause smoking, a fire or electric shock.)

● Clean the power plug regularly.
(A soiled power plug may cause insufficient insulation due to the moisture, and lint build-up, which may cause a fire.)
→ Unplug the power plug, and wipe with the dry cloth.

Safety Precautions

Please make sure to follow these instructions

⚠ WARNING

❗ Stop using the appliance immediately and unplug when abnormality or breaking down occurs.

(It may cause smoking, a fire or electric shock.)

e.g. for abnormality or breaking down:

- The power plug and the power cord become abnormally hot.
 - The power cord is damaged or power failure happens when the power cord is touched.
 - The main body is deformed or is abnormally hot.
 - Smoke emanates from the main body or a burning odour is detected.
 - The main body is cracked, is loose or rattles.
 - The fan in the bottom does not rotate while cooking.
- Please contact an authorised dealer for inspection or repair immediately.

● Close the Outer Lid slowly and firmly until it clicks.

(To prevent a burn or injury by steam leaking or the opening of the Outer Lid.)

- To ensure that the Outer Lid can be closed, remove foreign objects such as rice grains on the Clear Frame, Packing of the Inner Lid, Packing of the Outer Lid, the edge of the Inner Pan or around the Hook Button.

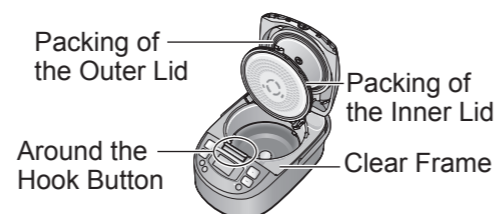

● Keep the power cord out of reach of children.

- Do not let the power cord hang over the edge of the table or countertop.

(Pulling on the power cord may result in the appliance falling from the table or countertop, causing an injury.)

● Always keep children away from the appliance.

(It may cause a burn, injury or electric shock.)

- Children do not realize dangers that are likely to occur because of improper use of electrical appliances.



● Be careful not to trip over or become entangled with the power cord while in use.

(Otherwise it may result in an injury, or the damaged power cord causing a fire or electric shock.)

● Use a power outlet which you are sure includes an earth.

- The power plug of this appliance is designed for a power outlet with an earth.

(Use of a power outlet without an earth may result in a malfunction or electric shock due to electrical leakage.)

⚠ CAUTION

❗ Do not expose the power plug to steam.

- Do not expose the power plug to steam when it is plugged in.

(It may cause an electric shock, or fire caused by short circuit.)
→ When using a cabinet with sliding table, use the appliance where the power plug cannot be exposed to steam.

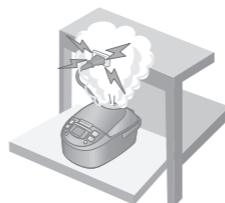

● Do not use a deformed Inner Pan or an unspecified pan.

(It may cause a burn or injury due to overheat or malfunction.)

● Do not touch heating elements while the appliance is in use or after cooking.

- The Steam Cap, Inner Lid, metal parts, such as the Clear Frame, and Inner Pan.

(It may cause a burn.)

→ Use a dry cloth or oven mitts when removing the Inner Pan while it is hot.



⚠ CAUTION

❗ Do not touch the Hook Button while moving the appliance.

(It may cause the Outer Lid to open, resulting in a burn.)

Hook Button



● Do not use the appliance on following places.

- Places where it may be splashed with water or near a heat source. (It may cause an electric shock, electrical leakage or fire.)
- On an uneven surface or on non-heat-resistant carpet. (It may cause an injury, burn or fire.)
- Near a wall or furniture. (It may cause discolouration, deformation or damage.)
→ Open the Outer Lid in an area away from surrounding objects such as the wall or furniture.
- On aluminium sheet or electronic carpet. (Aluminium materials may generate heat and cause smoking or a fire.)

● Do not turn on the appliance without rice and water inside.

(It may cause a burn.)

● Do not use the cord set (for an instrument plug and power plug) that is not specified for use with this appliance. Also do not transfer it.

(It may cause an electric shock, electrical leakage or fire.)

❗ Be sure to hold the power plug or the instrument plug when unplugging the power plug or the instrument plug.

(Otherwise it may cause an electric shock, or fire caused by short circuit.)

● Always switch off and unplug the appliance from the power outlet when it is not in use or before removing the Inner Pan.

(Otherwise it may cause a burn, injury, or electric shock or fire caused by short circuit due to the insulation deterioration.)

● Unplug and allow the appliance to cool down fully before cleaning and storing it.

- Do not move the appliance while it is hot. (Touching hot elements may cause a burn.)

● If using the appliance on a kitchen shelf etc., ensure that the steam is not confined within a closed space.

(It may cause discolouration or deformation.)

- If using a slide-out shelf, pull the shelf out fully to ensure that the shelf above is not exposed to steam.

● If using the appliance on a slide-out table etc., ensure that the shelf is capable of supporting 10 kg or more for the 1.0 L model, or 13 kg or more for the 1.8 L model.

(It may cause a burn or injury due to the appliance falling.)

● Hold the Handle when moving the appliance.

(Otherwise it may cause a burn or injury.)



● Please consult a doctor if you are using an implanted pacemaker.

- The operation of this appliance may affect your pacemaker.

If the power stops during use

Includes if the power plug is removed, or the power circuit breaker is tripped during use.

- If power is interrupted, the Warm Jar will return to the state it was in before interruption.

- If the power stops for a long period of time, the Warm Jar will return to the following state when power resumes.

Cooking: Continues cooking.

Keeping warm: Continues keeping the rice warm.

The rice may be cooked in an unsatisfactory way.

*It will start cooking immediately if the set time of the timer has elapsed. The rice may not be cooked by the set time. For further details on "Timer Setting Restriction", see P. 26.

Notes on Use

To keep the product in good condition over the long term, please observe the following.

About the Warm Jar

- **Do not use the Warm Jar on an IH hob.**
(Doing so may damage the Warm Jar or hob.)
- **Do not use in a location subject to direct sunlight.**
(Doing so may result in discolouration.)
- **Do not use in a location (on a carpet, plastic bag, aluminium foil, fabric etc.) where the bottom of the Warm Jar (the Intake and Exhaust Vents) is restricted.**
(Doing so may damage the Warm Jar.)
- **Periodically check the Intake and Exhaust Vents at the bottom of the Warm Jar and then remove any dust etc.** (P. 19)
- **Do not use the Warm Jar outdoors.**
(An unstable power supply may cause the Warm Jar to develop a fault.)
- **Do not cover the top of the Warm Jar when it is in use.**
 - Dishcloths etc.
 - (Steam may be confined near the Warm Jar and cause the Outer Lid or buttons to deform or stop operating.)



- **Do not use the Warm Jar with foreign objects such as rice grains or other dirt stuck to it.**
 - Doing so may result in an error message being displayed, and the rice being burnt or otherwise cooked in an unsatisfactory way.
 - This may cause steam to leak during cooking, and cause damage to the appliance.
- **Do not place the Warm Jar near devices vulnerable to magnetic fields.**
 - Radios, televisions, hearing aids etc.
(Noise may be heard or volume levels reduced.)
 - IC cards/bank cards etc.
(Records held on the card may be lost or damaged.)
- **Do not bring magnets close to the Warm Jar.**
(Doing so may result in faulty operation.)

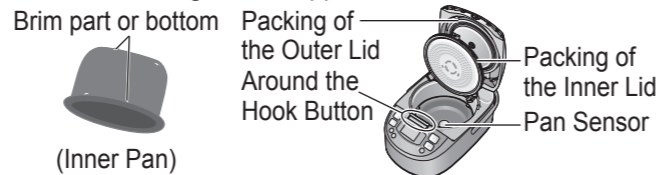

About the Inner Pan

- **Do not use the Inner Pan except in the Warm Jar.**
 - Do not use on a gas hob or IH hob, or in a microwave.
- **Do not strike against hard objects.**
(Doing so may scratch or dent the outer surface.)



■ Observe the following to prevent peeling or scratching of the inner coating.

During preparation

- **Do not use a whisk or other tool when washing the rice.**
- **Do not allow a metal strainer etc. to contact the inner coating.**

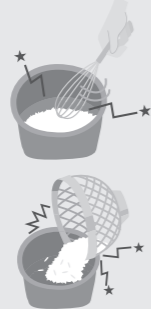

When rice is cooked

- **Do not mix salt or sprinkle etc. with the rice while it is in the Inner Pan.**
- **Do not mix vinegar with the rice while it is in the Inner Pan (for sushi etc.).**
- **Do not use a metal ladle (for congee etc.).**
- **Do not tap or hit the Inner Pan (when serving etc.).**



When cleaning (P. 18-19)

- **Do not use as a washing-up bowl.**
Do not put spoons or other cutlery into the Inner Pan.
- **After cooking with seasoning, do not leave the food in the Inner Pan.**
→ After cooking casserole rice etc., remove it from the Inner Pan as soon as possible and wash the Inner Pan.
- **Do not use a dish dryer or dishwasher/dryer.**
- **After washing, do not leave on other crockery to dry.**
- **Do not wash or scrub with an abrasive, a metal scourer, a nylon scourer impregnated with polish etc..**
→ Wash using a soft sponge.
Do not wash using the scouring pad.

Note ● The following do not affect performance or human health.
[Outer surface] Shallow scratches, small dents or bumps.
[Inner surface] Peeling of inner coating.
→ A new Inner Pan can be purchased if the Inner Pan has changed shape or you are concerned about the condition of the Inner Pan.

Part Names/Accessories

■ Before using the Warm Jar for the first time, please wash the accessories, Inner Pan, Inner Lid and Steam Cap. (P. 18-19)

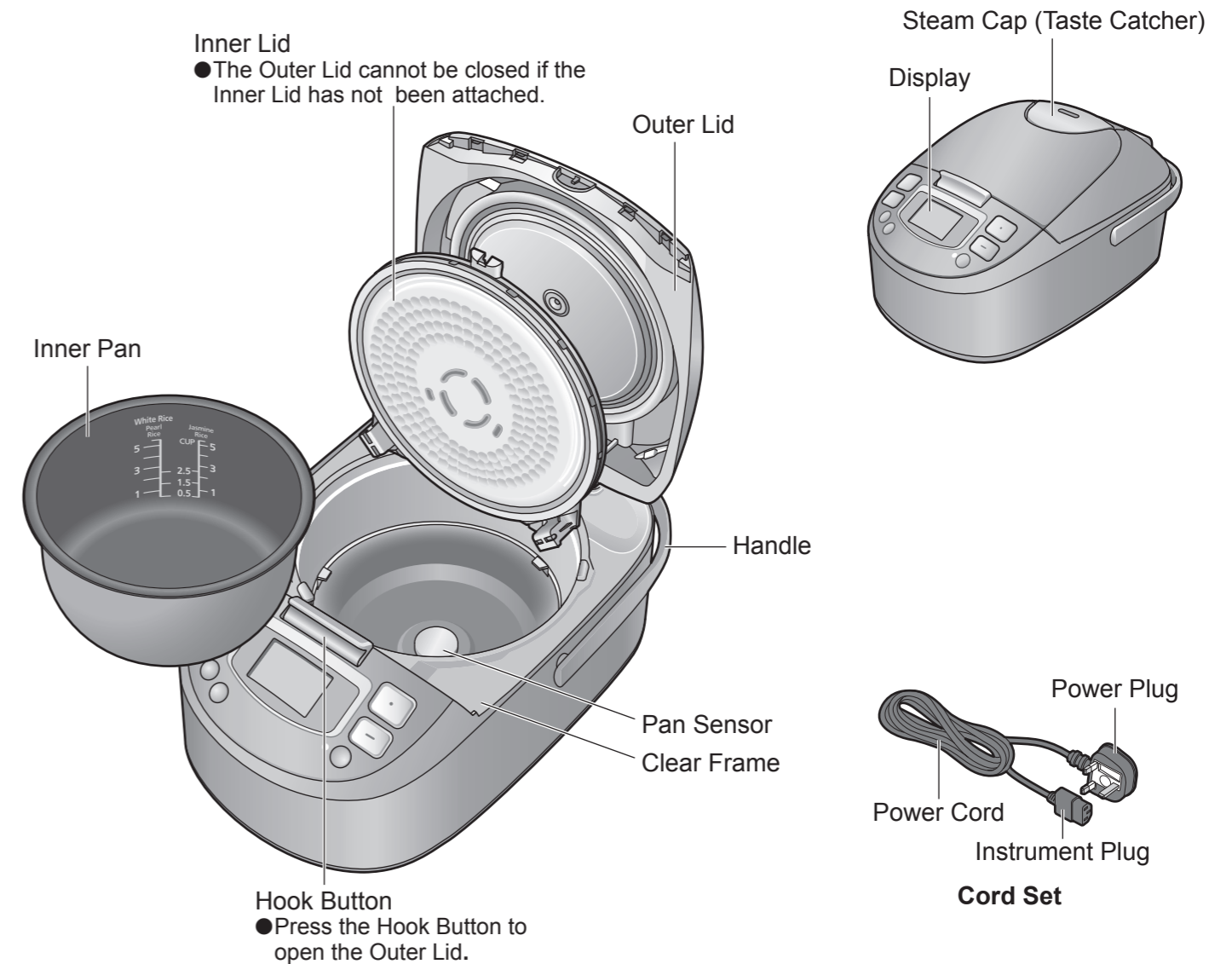

Accessories

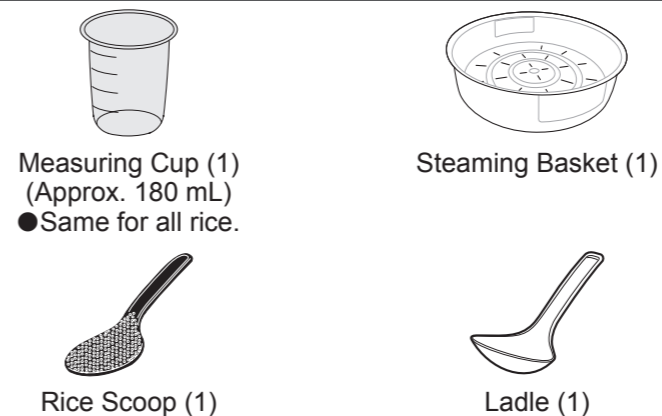

Note ● As an aid for the visually impaired, the "Start" and "Cancel/Off" buttons have raised parts "●" and "■".

Cooking Rice

Washing the rice and adding water

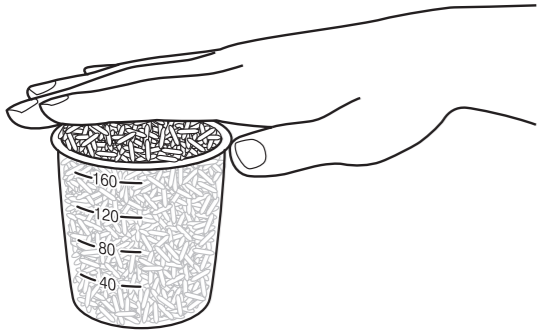

1 Measure the rice

- Measure by levelling off in the supplied measuring cup. (Approx. 180 mL/cup)

2 Wash the rice

- ① First, add plenty of water, stir, and quickly throw away the water.
- ② Repeat this process 2 to 5 times, stirring gently to wash the rice each time. (It is acceptable if the cooking water is slightly cloudy.)
- ③ Put the washed rice in the Inner Pan. (The rice can be washed in the Inner Pan.)

Precaution

- Do not leave the rice in a strainer for any length of time. (The rice grains may break, causing the rice to stick or burn when cooked.)

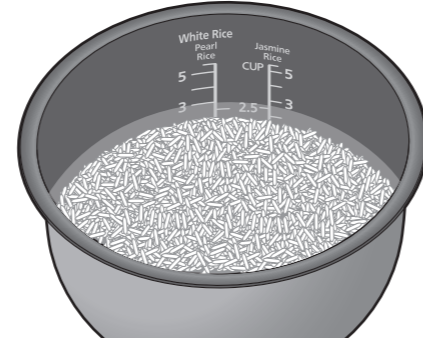

3 Add water

- Add water up to the mark (Water Level) for the desired cooking program. (P. 10) (Ensure that the Inner Pan is on a level surface and check the marks on both sides.)
- Add the correct amount of water for the number of cups of rice. Adjust water by approximately 1 to 2 mm from the Water Level according to your preference. (Adding too much water may cause liquid to spill out, increase the cooking time or adversely affect the flavour of the rice.)
 - Use a little less water than indicated for new-crop rice.
 - Use a little less water than indicated for harder rice and a little more than indicated for softer rice.
- Ensure the rice is level.
- Soaking the rice is not required. (When the "Start" button is pressed, the water will be absorbed automatically.)

Using the "Jasmine Rice/Delicious" program with 3 cups of rice

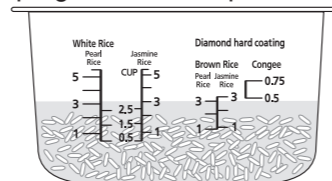

The Inner Pan in the illustration is the 1.0 L model.

Setting up

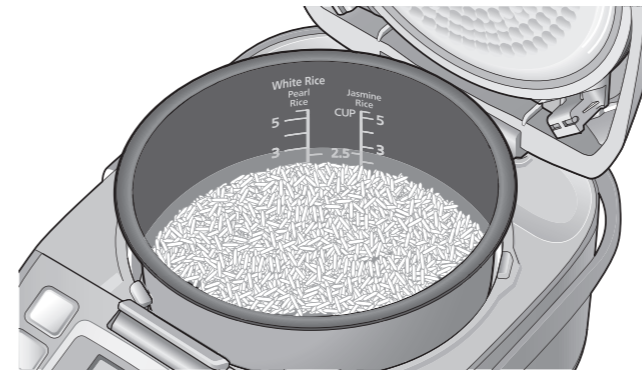

4 Place the Inner Pan in the Warm Jar

- Wipe away any water etc. on the outside of the Inner Pan.

5 Close the Outer Lid

- Check that the Inner Lid and Steam Cap are set in place. (P. 18–19)

Cooking

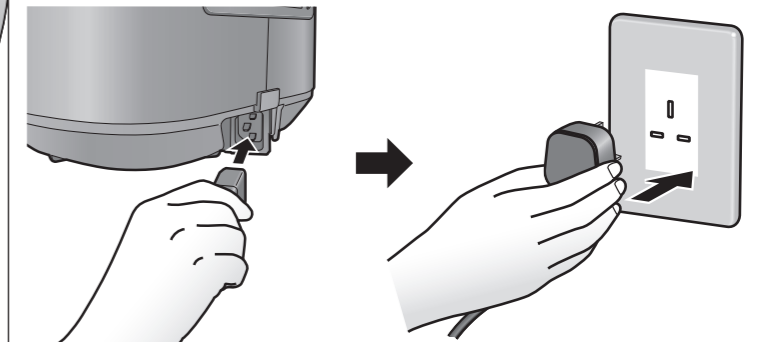

6 Insert the Power Plug

- Please connect the Instrument Plug to the body first and then connect the Power Plug. Make sure that both plugs are firmly connected.

7 Check the program and press the "Start" button.

By default, the program is set as "Jasmine Rice/Delicious" at the time of purchase. When changing it. (P. 11)

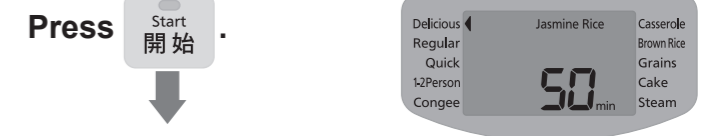

Cooking starts.

- When the buzzer sounds after cooking, the steaming stage has finished. Mix the rice immediately. (This is to allow excess moisture to evaporate.)
- Automatically switches to the keep warm function. (P. 13)

Three rules for delicious rice



Measure out the water and rice correctly.



Wash the rice gently.

Heavy-handed washing of the rice can result in the grains splitting, causing the rice to stick or burn.



Use suitable water.

We recommend the use of tap water or filtered tap water.

- Use of alkaline water (with a pH higher than 9) may result in sticky or yellow-coloured rice.
- Use of hard mineral water (with hardness of 100 or above) may result in dry or hard rice.



Things to look out!



- Where possible, choose recently processed rice.
- After opening a bag of rice, use it promptly.
- Keep rice in the fridge.

Using the Programs Correctly

	Program	Water Level of Inner Pan	Cooking time (approx.)	
Best flavour	Pearl Rice Jasmine Rice	Delicious This is the default setting. White Rice Pearl Rice/ Jasmine Rice	50 min	
Regular cooking		Regular White Rice Pearl Rice/ Jasmine Rice	37 min	
Quick cooking		Quick Rice will be slightly harder. You can soften the rice by soaking it before cooking. White Rice Pearl Rice/ Jasmine Rice	19 min–33 min	
Cook small amount		1-2Person 1.0 L model (0.5 to 1.5 cups) 1.8 L model (1 to 2.5 cups) White Rice Pearl Rice/ Jasmine Rice	50 min	
Cook congee		Congee 1.0 L model (0.5 to 0.75 cup) 1.8 L model (0.5 to 1.5 cups) Congee	Setting time 1 h–4 h	
Cook casserole rice		Casserole White Rice Pearl Rice/ Jasmine Rice	50 min	
Cook brown rice		Brown Rice Brown Rice Pearl Rice/ Jasmine Rice	1 h 35 min– 1 h 55 min	
Cook rice of various grains		Grains White Rice* Pearl Rice/ Jasmine Rice	45 min–55 min	
Bake a cake		Cake	—	Setting time 40 min–60 min
Steam		Steam	—	Setting time 1 min–60 min

*Adjust the amount of water to suit kinds of grains or your taste.

- There are two water levels for White Rice or Brown Rice: “Pearl Rice” and “Jasmine Rice.” Select the correct water level to suit the type of rice being cooked.
- The actual cooking time will vary according to the amount of rice, amount of water, voltage, temperature, water temperature and rice quality.
- The cooking time for “Casserole”, “Grains” will vary according to the ingredients used.

● Do not mix brown and white rice. (Rice will not cook properly.)

Using Different Programs

● For “Cake” and “Steam” programs (P. 12)

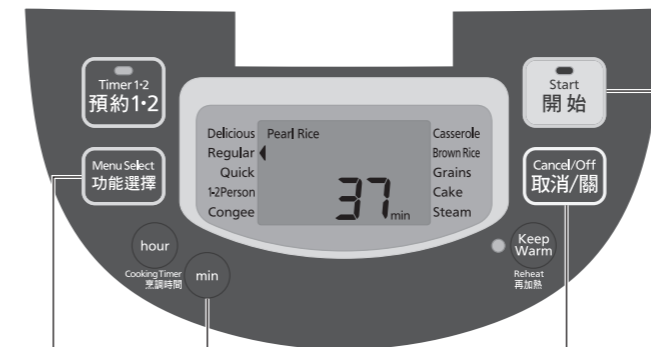

1,2

● To set the cooking time when selecting the “Congee” program in step 2

3

● To cancel an operation

Do I have to select a program every time?

● The “Delicious” and “Regular” settings under “Pearl Rice” or “Jasmine Rice” are stored. For other programs, the following operation allows you to call up the most recently used program. (The “Cake” and “Steam” programs cannot be called up.)

1 Press and hold down **Menu Select** (功能選擇)

(for approximately 2 seconds)

- You will hear a “beep” as soon as you press the button, but continue to hold it down. You will hear a second “beep” and the most recently used program will appear.

2 Press **Start** (開始) **Flashing**

1 Select a type of rice

Press **Menu Select** (功能選擇)

- The “◀” position moves each time the “Menu Select” button is pressed, and changes between “Jasmine Rice” and “Pearl Rice” after “◀” goes through one cycle.

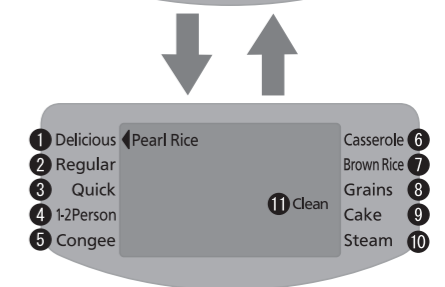

2 Select a menu

Press **Menu Select** (功能選擇) and set “◀” to a menu.

- When the “Congee” program is selected, set the cooking time.

Press **min**.

Allowable timer setting	Unit
1 h–4 h	30 min

3 Press the “Start” button

Flashing

Press **Start** (開始)

Cooking starts.

- When the buzzer sounds after cooking, the steaming stage has finished. Mix the rice immediately. (This is to allow excess moisture to evaporate.)
- Automatically switches to the keep warm function. (P. 13)
- To cook congee continuously, leave the Outer Lid opened and allow to cool the Warm Jar without the Inner Pan for 5 minutes or more.

Notes

- “Clean” is displayed when it is selected.
- To make it easier to distinguish between decision points (for instance, the “Menu Select” button being at “Jasmine Rice/Delicious”), the beeping sound has been changed to “beep-beep”.
- The display changes according to the selected cooking program. For the “Quick”, “Brown Rice” and “Grains” settings, the Warm Jar will display the current time until approximately 10 minutes before the rice is ready. It will then switch to show the time until the rice is ready.

Cooking



Cook

- 1 Select a cooking menu**
Press **Menu Select 功能選擇**, set "▶" to a cooking menu.

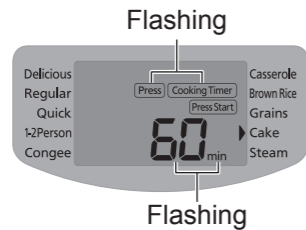

Bake a cake : "Cake"
Steam : "Steam"

- 2 Set the cooking time**
Press **min**.

Menu	Allowable timer setting	Unit
Cake	40 min–60 min	1 min
Steam	1 min–60 min	1 min

* Countdown of the steam setting time begins when the Warm Jar starts releasing steam.

- 3 Press the "Start" button**

Press **Start 開始**.



Cooking starts.

- When cooking finishes, the Warm Jar automatically switches to the keep warm function, so please turn off the Warm Jar.

Press **Cancel/Off 取消/關**.

- 1**
- 2**
- 3**

Note

Available capacity

Menu	1.0 L	1.8 L
Cake	Dough Max 600 g	Dough Max 900 g
Steam	Quantity of water 500 mL	Quantity of water 600 mL

How to use the Steaming Basket

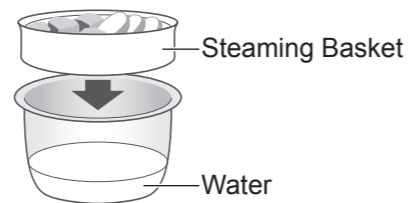

Precautions

When steaming...

- Please do not block the hole in the Inner Lid with ingredients.

After cooking...

- Do not use the keep warm function. (It may cause odours, rot or rusting the Inner Lid.)
- The inside of the Outer Lid and the vicinity of the Inner Pan will be hot after cooking, so please be careful when removing cooked food.
- When the Outer Lid is opened after cooking, water droplets may drop from the Inner Lid onto the Clear Frame.
→ Wipe these away with a well-wrung cloth.
- Always wash the Inner Lid and the Steam Cap. Wipe the inner surface of the Outer Lid, the attaching portion of the Steam Cap and the Packing. When cooking recipes with a high meat content, the fats and proteins of the meat can contaminate the Inner Lid and inner surface of the Outer Lid. (It may cause odour, rot or rusting the Inner Lid.)

Keeping Warm

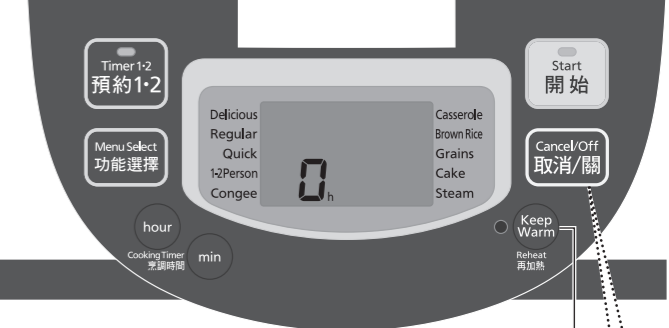

Keep Warm (Automatic)

- Once the rice is cooked, all programs switch automatically to the keep warm function. (Please mix the rice immediately after cooking ends.)

- To reheat from the keep warm state
- To return to the keep warm state

● To turn off the keep warm function
Press **Cancel/Off 取消/關** and then remove the Power Plug.

	<ul style="list-style-type: none"> ● Delicious ● 1-2Person 	<ul style="list-style-type: none"> ● Regular 	<ul style="list-style-type: none"> ● Quick
<p>The Warm Jar will switch automatically to the keep warm function, but we do not recommend this.</p>	<ul style="list-style-type: none"> ● Congee If congee is kept warm, it may become very sticky. 	<ul style="list-style-type: none"> ● Casserole Use of the keep warm function can also cause the Inner Lid to rust, adversely affect the flavour of the rice. 	
	<ul style="list-style-type: none"> ● Brown Rice ● Cake 	<ul style="list-style-type: none"> ● Grains ● Steam 	<ul style="list-style-type: none"> ● Flavour can be adversely affected. It may cause odour, rot or rusting the Inner Lid.

Precautions

- Do not use the keep warm function for more than 12 hours. (To prevent odour or rice becoming yellow or dry.)
- Do not cancel the keep warm function or remove the Power Plug while leaving the rice in the Warm Jar. (To prevent odour and condensation.)
- Do not use the keep warm function with the Rice Scoop still in the Warm Jar. (To prevent odour.)

Notes

- A keep warm time of up to 23 hours is displayed in 1 hour units ("0" is displayed for times of less than 1 hour). The keep warm function will continue for more than 24 hours, however the display will switch to the current time.
- Removing the Power Plug without pressing the "Cancel/Off" button will return to the keep warm function when the Power Plug is connected next.

Reheat (manual)

- Rice to be heated to high temperature from the keep warm state.

- 1 In the keep warm state Mix the rice**
- 2 Press the "Keep Warm" (Reheat) button**

Press **Keep Warm**.

Flashing (Approx. 5 min–7 min)
Reheat starts.

Notes

- Reheat cannot be used in the following situations.
 - When the rice is cold (buzzer beeps 4 times).
 - When the keep warm function is not in use.
- Reheating two or more times will adversely affect the flavour of the rice.

- When the buzzer sounds, mix the rice immediately. The rice is now ready to be eaten.

Using the Timer

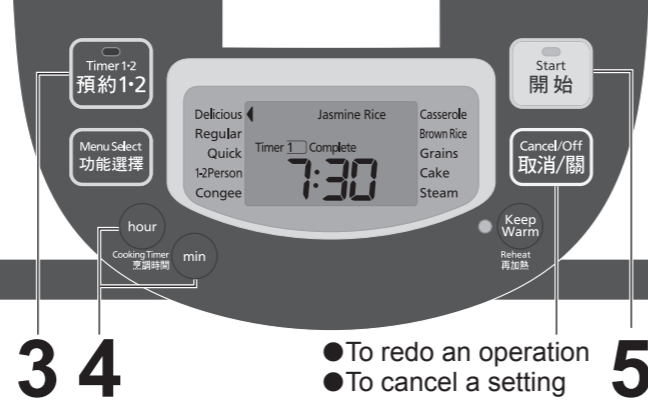

Timer

● **Two timers can be set.** (These are stored until changed.) You may find it convenient to store often used times, using, for example, "Timer 1" for breakfast and "Timer 2" for your evening meal.

For example: Setting to 7:30 am

1 Check that the current time is correct

● If the time is incorrect, set it by following the procedure on the right.

2 Check the program

(Set to desired program. Step 1–2 on P. 11)

● When using the timer for the "Congee" program, first set the cooking time and then press "Timer 1•2" button. Under timer mode, press "min" button to check the set cooking time.

3 Select "Timer 1" or "Timer 2"

Press **Timer 1-2 預約1•2**



● Each press of the button changes the selection.

Timer 1 ↔ Timer 2

4 Set the time at which the rice is to be ready

hour Forward (units of 1 hour)

min Forward (units of 10 min)

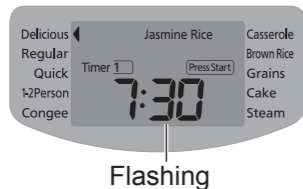

● Hold down to cycle through time faster.

5 Press the "Start" button

Flashing

Press **Start 開始**



Setting ends.

● When the buzzer sounds after cooking, the steaming stage has finished. Mix the rice immediately. (This is to allow excess moisture to evaporate.)
● Automatically switches to the keep warm function. (P. 13)

Precaution ● Do not set the timer to 13 hours or longer (8 hours or longer when the water temperature is high). (Doing so may cause the rice to ferment and generate undesirable odours.)

Notes ● If there is insufficient time for the timer setting, the timer will not allow the setting, and cooking will start immediately. (See "Timer Setting Restriction" on P. 26.)
● The timer cannot be used with the "Quick", "Casserole", "Cake" or "Steam" program.
● When cooking with the timer, the time until the rice is ready is not displayed.
● When cooking with the timer, the rice may absorb excess water. This can result in the rice becoming soft or burnt.
→ Reduce the amount of water slightly if the rice is soft. (Reduce water by approximately 1 to 2 mm from the Water Level.)

When the current time is incorrect

● The time is displayed in 24-hour clock format.

1 Insert the Power Plug

2 Hold down **hour** or **min** for 1 second or more

● Release your finger when you hear a "beep".



Flashing

3 Set the time

hour Forward (units of 1 hour)

min Forward (units of 1 min)



When the flashing stops, the time is set.

● Hold down to cycle through time faster.

● The time cannot be set in use such as cooking/the keep warm state/the timer and cleaning function settings.

● When the lithium battery runs down, removing the Power Plug will result in the loss of stored data such as the current time and timer settings. (P. 20)

● The lithium battery is fixed inside the main body and cannot be replaced by the user. For a replacement of lithium battery, please consult the dealer where you purchased the Warm Jar or a service centre.

To see the current time after setting the timer.

Lighting

Press **Timer 1-2 預約1•2**

● Press and hold to display.

Congee/Casserole

Pork and Century Egg Congee



Ingredients (Serves 2 to 3):

White rice ½ cup
Meat broth (cooled) 5 cups
Century egg 1 pc
Cooked lean pork 125 g

Seasoning:

Salt 1 tsp
Pepper To taste
Sesame oil To taste

Method:

① Marinate the cooked lean pork with the salt for 1 hour and then cut into thin strips. Dice the century egg and put aside for later use.
② Wash the white rice and then pour into the Inner Pan together with the meat broth and close the Outer Lid.

③ Select the program and set cooking time to **1 hour and 30 minutes**.

Menu Select	Pearl Rice/ Jasmine Rice
	Congee

④ Press the "Start" button.

⑤ When the buzzer sounds, press the "Cancel/Off" button, open the Outer Lid*, add the lean pork and century egg to the Inner Pan and close the Outer Lid.

* When open the Outer Lid, please note that the cooked food gets hot.

⑥ Select the program and set cooking time to **1 hour**.

Menu Select	Pearl Rice/ Jasmine Rice
	Congee

⑦ Press the "Start" button.

⑧ When the buzzer sounds, the congee may be served after it has been seasoned.

Chicken and Taro Casserole Rice



Ingredients (Serves 4 to 6):

White rice 3 cups
Chicken meat (diced) 200 g
Dried mushrooms (soaked & sliced) 5 pcs
Taro (diced) 100 g
Dried shrimps (soaked) 40 g
Chinese black fungus (soaked & chopped) Few pcs

Marinade:

A Light soy 1 tsp
Dark soy ½ tsp
Sugar 1 tsp
Salt ½ tsp
Starch 1½ tsp

Sauce:

B Light soy 1 tbs
Dark soy 1 tbs
Sugar ½ tbs
Sesame oil ½ tbs

Important Information:

● When placing ingredients they cannot go above the maximum water level of White Rice.
● Do not open the Outer Lid while cooking. (Cooking result may not be satisfactory.)

Model	Amount of rice (Cup*)
1.0 L	1–3
1.8 L	2–6

* Measuring Cup provided as an accessory.

Method:

① Season diced chicken meat with A.
② Deep fry diced taro root until golden brown, drain and set aside.
③ Wash the white rice and place it in the Inner Pan with water up to "Water Level: **White Rice (Pearl Rice/Jasmine Rice) 3**". Then place ①, ② and other ingredients evenly on the rice and close the Outer Lid. (Do not mix.)

④ Select the program.

Menu Select	Pearl Rice/ Jasmine Rice
	Casserole

⑤ Press the "Start" button.

⑥ When the buzzer sounds, add B and stir the rice immediately to loosen it.

Brown Rice/Grains

Brown Rice



Ingredients (Serves 4 to 6):
 Brown rice 3 cups
 White sesame Small amount
 Black sesame Small amount

Method:
 ① Gently wash the brown rice and remove debris and loose husk.
 ② Add water up to "Water Level: **Brown Rice (Pearl Rice/Jasmine Rice) 3**" and close the Outer Lid.
 ③ Select the program.

Menu Select	Pearl Rice/ Jasmine Rice
	Brown Rice

④ Press the "Start" button.
 ⑤ When the buzzer sounds, turn it over and mix to fluff.
 ⑥ Put on a plate and sprinkle on some white and black sesame.

When cooking with other ingredients (meat, vegetables etc.)

- Measure the water level before adding the other ingredients.
- The rice takes a long time to cook so we recommend that you add firm ingredients such as beans etc. If you wish to add dried ingredients, be sure to rehydrate them first.
- The quantity of other ingredients should not exceed 75 g per cup of rice.
- Cut the ingredients into small pieces and lay them on the rice without mixing. If you mix the ingredients with the rice, the rice will not be cooked properly.

Multigrain Rice



Ingredients (Serves 4 to 6):
 White rice 3 cups
 Multigrain 30 g

Method:
 ① Wash the white rice and add water up to "Water Level: **White Rice (Pearl Rice/Jasmine Rice) 3**".
 ② Gently wash the multigrain and place on ①.
 ③ Add another 30 mL of water* and close the Outer Lid.
 * Adjust the amount of water depending on the type of multigrain and preferences.
 ④ Select the program.

Menu Select	Pearl Rice/ Jasmine Rice
	Grains

⑤ Press the "Start" button.
 ⑥ When the buzzer sounds, turn it over and mix to fluff.
 ⑦ Arrange in a dish.

To cook multigrain rice...

- If you wish to add beans or dried ingredients such as cloud ear mushrooms, be sure to rehydrate them first.
- The proportion of the other grain in the rice is 10% or below. (If too much other grain is added, the rice will not be cooked properly.)
- If you wish to cook multigrain rice softer, you add some more water or soak it in water in advance.

Cake/Steam

Soy Milk Cake



Ingredients (Serves 4 to 6):
 Butter or salad oil. . . . Small amount
 Pancake mixture 200 g
 Eggs 2 pcs
 Soy milk 100 mL
 Salad oil 3 tbs
 Raisins 70 g
 (May be substituted for other dry fruit.)

Method:

① Lightly smear the inside of the Inner Pan with butter or salad oil.
 ② Mix the ingredients until texture is smooth. (Do not mix in the Inner Pan.)

③ Pour ② into the Inner Pan and close the Outer Lid.
 ④ Select the program and set the cooking time to **40 minutes**.

Menu Select	Cake
-------------	------

⑤ Press the "Start" button.
 ⑥ When the buzzer sounds, remove the Inner Pan from the Warm Jar and turn it upside down to remove the cake. Then allow to cool on plate or mesh.

* When using the 1.8 L model, increasing the quantity of ingredients 1.5-fold and setting the cooking time to 60 minutes is recommended for a nice, fluffy cake.

Salted Meat Steamed with Chinese Cabbage



Ingredients (Serves 4 to 6):
 Chinese cabbage 100 g
 Salted meat (Chinese ham) 35 g

Method:

① Break the chinese cabbage into individual pieces and wash these pieces. Slice the salted meat and place aside.
 ② Arrange the individual pieces of cabbage in layers on the plate and layer the sliced salted meat at the very top (try to use the fatty parts of the meat).
 ③ Pour 2.5 cups of water in the Inner Pan.

④ Set the attached Steaming Basket, put "②" on it and close the Outer Lid.
 ⑤ Select the program and set the cooking time to **13 minutes**.

Menu Select	Steam
-------------	-------

⑥ Press the "Start" button.

Note:

When chinese cabbage is unavailable, the heart of the bok choy may be used instead.

Precaution

- Please do not block the hole in the Inner Lid with ingredients.

Cleaning

- For cleaning, remove the Power Plug and ensure that the main body has cooled down.
- The Packing attached to both the main body and the Inner Lid cannot be removed. Do not pull by using excessive force or puncture with sharp-pointed objects. (This may cause defects, delamination and damage.)
- After washing, wipe with a dry cloth.

When using for the first time & on every use



- After removing, wash with a soft sponge.
*When using a washing-up liquid, check the precautions of it.



- After using seasoning, such as casserole rice, wash promptly.
(Since these can cause odours, rot, or rust.)

<Do not use any of the following>

Metal scourers, nylon scourers impregnated with an abrasive etc.

Do not wash using the scouring pad.

Benzine, thinner, polish, bleach, antibacterial alcohol etc.

Dishwasher/dryer or dish dryer



Inner Pan (P. 6) • Rice Scoop • Ladle • Steaming Basket

Wash with a mild washing-up liquid.

Precaution

- Do not use the Inner Pan as a washing-up bowl.
(Since this may result in peeling of the inner coating.)



Inner Surface of Outer Lid • Packing

Wipe with a well-wrung cloth.

- Remove the Steam Cap and wipe the inner surface of the Outer Lid, the attaching portion of the Steam Cap and the Packing.

Note

- May become dirty easily when increasing the amount of water or cooking brown rice etc.

Inner Lid

Remove and wash with a mild washing-up liquid.

- Remove any dirt such as rice from the packing.

Removing

Hold both Inner Lid knobs and pull forward to remove the fixture.

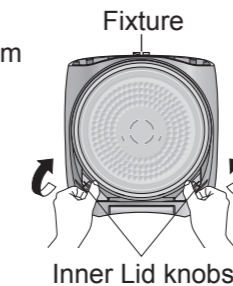

Attaching

- ① Insert the Fixture into the groove at the top.
- ② Press on both Inner Lid knobs into the Outer Lid until you hear a "click".

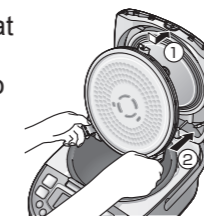

Precaution

- After cooking with seasoning (for casserole rice etc.) or baking a cake, please wash promptly.
(Since this may cause odours, rot, or rust.)

Pan Sensor

Wipe with a well-wrung cloth.

- If the dirt is hard to remove, dab a mild washing-up liquid on a nylon scourer and wipe gently.

Note

- Using the Pan Sensor while they are dirty may result in the rice being burnt or cooked in an unsatisfactory way.

Regular checks

- Check around once a month and clean if dirty!

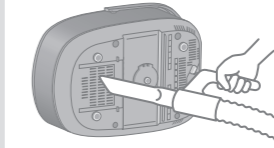

Bottom of Warm Jar
(Intake/Exhaust Vents)

Remove dust and foreign objects using a vacuum cleaner etc..

When the cleanliness of the Warm Jar is a concern

Cleaning function

If odour is hard to remove or the dirt does not come off the Inner Lid or Steam Vent....

Preparation

- ① Pour water into the Inner Pan.
(1.0 L model, "Pearl Rice/Jasmine Rice" Water Level: 3-4)
(1.8 L model, "Pearl Rice/Jasmine Rice" Water Level: 6-8)
- ② Put the Inner Pan in the main body and close the Outer Lid.

1 Display "Clean"

Press **Menu Select** 功能選擇 .

- "Clean" will be displayed when selected.



2 Press the "Start" button

Flashing
Press **Start** 開始 .

Cleaning function starts.

3 When the buzzer sounds after approximately 45 minutes, press the "Cancel/off" button

Press **Cancel/Off** 取消/關 .

- After the water in the Inner Pan has cooled, wash the Inner Pan, Inner Lid and Steam Cap.

Note

- It may not be possible to completely remove odour or dirt.

Steam Cap

Remove and rinse.

- Dew and dirt tend to remain in the Steam Cap, so please wash it after each use.
(This may cause odours or rot.)

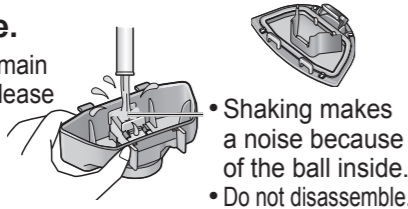

- Shaking makes a noise because of the ball inside.
- Do not disassemble.

Removing

- ① Pull up to remove.
- ② Remove the lever in the "←" direction to open.

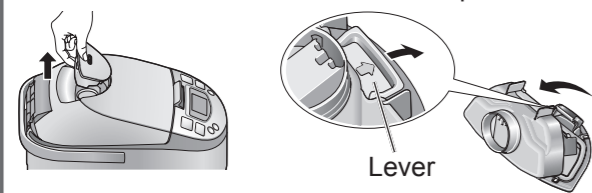

Lever

Attaching (In the reverse order to removing.)

- ① Insert the shaft and close the lever securely until you hear a "click".
- ② Attach on the Outer Lid.
(Ensure that it has been attached firmly.)

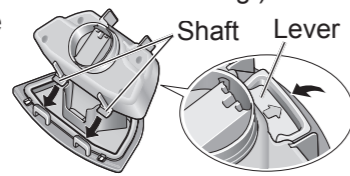

Shaft Lever

Precautions

- Do not remove the Packing.
(This may cause steam to leak.)
- If the Packing came off, please reattach along the groove.



Packing inserts along groove.

Clear Frame

Wipe with a well-wrung cloth.

- Remove any dirt such as rice from the around the Hook Button.

Precaution

- Do not wash by pouring in water etc.

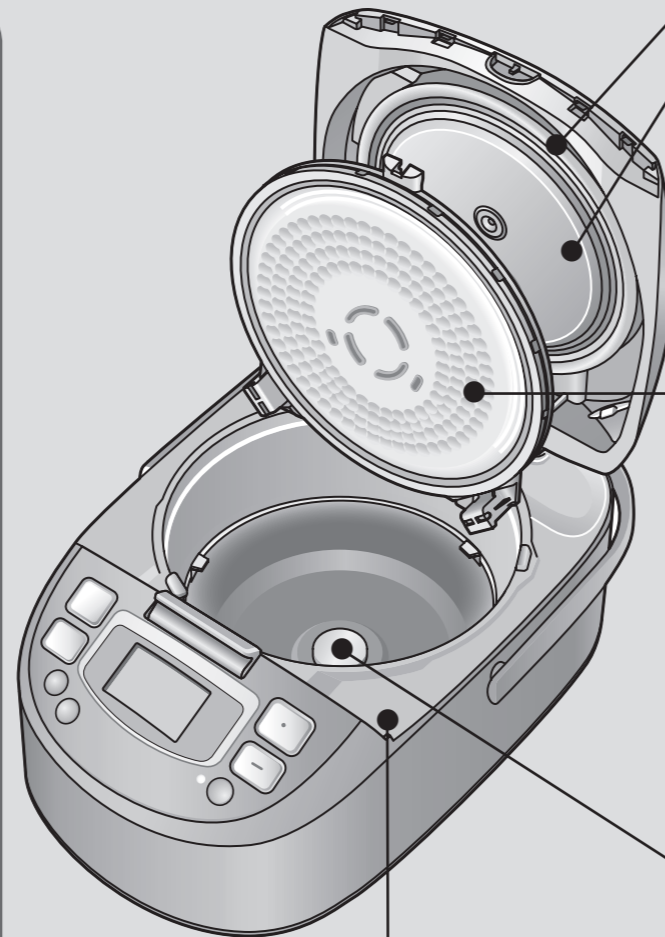

Does my Warm Jar have a fault?

Check the following before asking for a service.

	Symptom	Check here!	Page
Cooking	<ul style="list-style-type: none"> ● The remaining cooking time displayed stops. ● The cooking time is longer than expected. 	<ul style="list-style-type: none"> ● If rice is cooked one after the other, the cooking time may lengthen (by up to around 45 minutes). ● Is the quantity of water in the Inner Pan too much? If the quantity of water is increased, the cooking time may lengthen (by up to around 15 minutes). 	—
	Steam is emitted from a section other than the Steam Vent.	<ul style="list-style-type: none"> ● Is there rice stuck to the the Packing of the Inner Lid, Packing of the Outer Lid or the edge of the Inner Pan? ● Have you washed the Inner Lid each time and attached it correctly? ● Is the Inner Pan deformed in some way? → A new Inner Pan can be purchased if the Inner Pan has changed shape. ● Is the Packing of the Inner Lid, Packing of the Outer Lid deformed, peeling, or torn? → If steam leaks out, please contact the dealer where you purchased the Warm Jar. ● Did you close the Outer Lid slowly and firmly until it clicked? 	19
Cooking/Keep Warm State	The Warm Jar is making a noise.	<ul style="list-style-type: none"> ● Whirring noise...Sound of fan that allows heat to escape operating. ● High-pitched noise...Sound of IH (induction heating). You may sometimes hear this when keeping warm. ● Hissing noise...Sound of steam jetting out. <p>When opening/closing the Outer Lid</p> <ul style="list-style-type: none"> ● Clacking noise...Sound of the ball in the Steam Cap rolling. 	—
Timer	Cooking begins immediately despite use of timer.	<ul style="list-style-type: none"> ● Is the current time correct? (The time is displayed in 24-hour clock format.) ● Has the timer been set to a time outside the "Timer Setting Restriction"? 	14 26
	I have set the timer but cooking doesn't start.	<ul style="list-style-type: none"> ● When using the timer, the rice is soaked before cooking starts, and so the soaking time after cooking starts is shorter. Consequently, cooking starts slightly later than might be expected. 	—
	The rice is not ready at the time set on the timer.	<ul style="list-style-type: none"> ● Is the current time correct? (The time is displayed in 24-hour clock format.) ● Have you pressed the "Start" button? ● Has the timer been set to a time outside the "Timer Setting Restriction"? 	14 14 26
Other	A button operation is not working.	<ul style="list-style-type: none"> ● Button operations will not work when e.g. cooking/the keep warm state/the timer and cleaning function settings are in use. → Press the "Cancel/Off" button. 	—
	The "Keep Warm" (Reheat) button does not respond.	<ul style="list-style-type: none"> ● Is the keep warm function switched off? ● Is the rice cold? (Buzzer will sound 4 times.) Reheating is not possible if the temperature is 50 °C or lower. 	—
	"7:30" always appears when inserting the Power Plug.	<ul style="list-style-type: none"> ● The lithium battery has run down. The current time or set time cannot be stored, however you can cook rice or use the keep warm function. The current time must be set on each occasion that you use the timer. The lithium battery is fixed inside the main body and cannot be replaced by the user. → For a replacement of lithium battery, consult the dealer where you purchased the Warm Jar or a service centre. 	—
	Sparks were visible at the Power Plug.	<ul style="list-style-type: none"> ● Sometimes small sparks can be seen when inserting or removing the Power Plug. This is a phenomenon particular to IH (induction heating) techniques and not indicative of a fault. 	—

■ If you mistakenly add water or rice to the main body, please unplug and contact your dealer.

What does this mean?

Error message	Check here!
U 10	<ul style="list-style-type: none"> ● Is the Inner Pan set properly? ① Set the provided Inner Pan. ② Turn off the error message by pressing the "Cancel/Off" button. (After a while, the message turns off even without pressing the button.) ③ Operate it again.
U 12	<ul style="list-style-type: none"> ● Is the foreign object or dirt attached to the bottom part of the Inner Pan, Inner Lid or Pan Sensor? (P. 18–19) → Remove the foreign object or dirt and press the "Cancel/Off" button. ● Is there too much water in the Inner Pan? → Press the "Cancel/Off" button. (Upon next cooking, reduce the amount of water slightly.)
U 14	<ul style="list-style-type: none"> ● Has the keep warm function been in use for more than 96 hours? → Press the "Cancel/Off" button.
U 15	<ul style="list-style-type: none"> ● Is the Outer Lid open? ● Is the Steam Cap (Taste Catcher) fitted? (P. 18) → If the Steam Cap has been lost, please purchase another one from your dealer. Rice can be cooked or kept warm without the Steam Cap fitted, however <ul style="list-style-type: none"> • The rice may not taste good. (The rice will become dry if it is being kept warm.) • Congee may not cook properly. • Liquid may spill out. • "U15" may be displayed again after the rice has been cooked. ● Is the foreign object or dirt attached to the inside of the Steam Cap? → Remove the foreign object or dirt. (P. 18)
U25	<ul style="list-style-type: none"> ● Is the Intake or Exhaust Vent on the bottom of the Warm Jar blocked by dust etc.? → Remove the dust using the following procedure. <ol style="list-style-type: none"> ① Press the "Cancel/Off" button and then remove the Power Plug. ② Once the body has cooled down, remove the Inner Pan. ③ Remove the dust from the Intake/Exhaust Vents on the bottom of the Warm Jar. (P. 19) ● Is the Warm Jar being used on a carpet etc.? (P. 6) → Do not use the Warm Jar in a location where the bottom of the Warm Jar is restricted.
If none of the methods described above brings an improvement, please consult your dealer for a repair.	
H 00	<ul style="list-style-type: none"> ● Try removing the Power Plug and reinserting it. If "H00" appears again, this is a malfunction. → Please consult your dealer and inform them of the error message (the two-digit number after the "H").

Does my Warm Jar have a fault? / What does this mean?

What to do when...

●The Warm Jar does not have a fault.
Check the following before asking for a service.

Rice is too sticky (soft)

- Have you measured the quantities of rice and water correctly? (P. 8)
- Are there many broken grains in the rice?
- Have you been soaking the rice for long periods? (When using the timer, for example.)
 - When using the timer, try reducing the amount of water slightly.
(Reduce water by approximately 1 to 2 mm from the Water Level.)
- Are you using hot water to wash the rice?
- Are you using more than the specified amount of rice with the “1-2Person” program for small amounts? (1.0 L model: 0.5 to 1.5 cups, 1.8 L model: 1 to 2.5 cups)
- Are you using too much force to wash the rice?
(It may cause the rice grains to break, and the rice may be sticky when cooked.)
- When the rice is cooked, are you mixing it immediately? (To allow excess moisture to evaporate.)
- When cooking new-crop rice, are you using less water than normal?
(Reduce water by approximately 1 to 2 mm from the Water Level.)
- Are you leaving the rice in the strainer after washing?
(P. 8 This may cause the rice grains to break, and the rice may be sticky when cooked.)
- Do you prefer harder rice?
 - Reduce the amount of water slightly.
(Reduce water by approximately 1 to 2 mm from the Water Level.)



Rice is too hard (dry)

- Have you measured the quantities of rice and water correctly? (P. 8)
- Are you using the “Quick” program?
- Do you prefer softer rice?
 - Increase the amount of water slightly.
(Increase water by approximately 1 to 2 mm from the Water Level.)
 - Try soaking the rice (for 30 minutes to 2 hours) before cooking.



Rice is burnt

- Has the rice been processed and washed properly?
 - Is there dirt or foreign object stuck to the Pan Sensor, bottom of the Inner Pan or inside the main body?
 - Are you using the timer? (Have you been soaking the rice for long periods?)
 - Are you using too much force to wash the rice?
(It may cause the rice grains to break, and the rice may burn when cooked.)
 - Are there many broken grains in the rice?
 - Are you leaving the rice in the strainer after washing?
(P. 8 This may cause the rice grains to break, and the rice may burn when cooked.)
 - Cooking rice with seasoning such as casserole rice may be easily burnt.
 - A golden brown colour on the rice at the bottom of the Inner Pan is not indicative of a fault.
- If there is no improvement after following the above-described steps, see “If burning is a concern”. (P. 25)



Symptom

Check here!

Condensation appears.

- When the rice is cooked, are you mixing it immediately? (To allow excess moisture to evaporate.)
- During the keep warm state, did you turn the keep warm function off with rice still in the Warm Jar, or remove the Power Plug and leave the rice in the Warm Jar?
- A layer of mist may form depending on the cooking method.

Rice smells odour.

- During the keep warm state, did you turn the keep warm function off with rice still in the Warm Jar, or remove the Power Plug and leave the rice in the Warm Jar?
 - Has the keep warm function been in operation for 12 hours or more?
 - After cooking rice with seasoning such as casserole rice, an odour may remain.
 - Did you add cold rice during the keep warm state?
 - Has the rice been processed and washed properly?
 - Are you using the keep warm function with the Rice Scoop still in the Warm Jar?
 - Are you cleaning and maintaining your Warm Jar correctly each time you use it? Failure to correctly clean and maintain your Warm Jar may spoil the aroma and flavour of your meals.
Continuing to use your Warm Jar without cleaning it correctly will spoil your meals.
 - After baking a cake, an odour may remain.
- **When the smell becomes noticeable,**
- ①Carefully wash the Inner Pan, Inner Lid and Steam Cap. (P. 18–19)
 - ②If this does not remove the odour, use the Cleaning function. (P. 19)

Rice has a yellow colour.

- Has the keep warm function been in operation for 12 hours or more?
- Have you reheated repeatedly?
- Has the rice been processed and washed properly?
- With certain types of rice, a yellow colour will be left on the rice after cooking.

Rice is dry.

- Has the keep warm function been in operation for 12 hours or more?
- Have you reheated repeatedly?
- Is the Steam Cap attached correctly?
- Is there rice stuck to the the Packing of the Inner Lid, Packing of the Outer Lid or edge of the Inner Pan?
- Is the Inner Pan deformed in some way?
→ A new Inner Pan can be purchased if the Inner Pan has changed shape.

Congee is sticky.

- Have you been soaking the rice for long periods?
(When using the timer, for example.)
- Have you used the keep warm function on the congee?

A thin film is formed.

- Are you washing the rice too much, causing the rice grains to break?
- Has the rice been washed properly?
(Starch in the rice dissolves and reforms as a thin film on the surface. It is not harmful.)

Rice sticks to the Inner Pan.

- Depending on the type of rice, soft rice or sticky rice may stick easily.

The surface of the cooked rice has a concave shape.

- Was the rice spread evenly before cooking?
- This may be caused by the strong heating power that is characteristic of IH (Induction Heating). This is not a malfunction.

What to do when...



- If the suggestions on P. 22–23 do not bring about any improvement, you can change the settings.
- Steps 2, 3 and 4 must each be completed within 16 seconds. When no operation is performed for 16 seconds, the display returns to the current time. (Setting cannot be made.) → Please restart the procedure.
- After the setting is completed, the display returns to the current time.
- To go back to the previous setting, follow the procedure again.

If you want to change the keep warm temperature. (74→76→72)

1 Press **Menu Select** and set “◀” to “Quick”.



- Select “Quick” under “Pearl Rice” or “Jasmine Rice”.

2 Press **Keep Warm**. You will not hear a beep.

Press **Timer 1-2**. You will not hear a beep.

Press **Keep Warm**.

3 Press **Start**.

- The default setting is “74”.

4 When it smells

Press **Menu Select**.

Set to “76”.



After 10 seconds
(Setting ends automatically.)



When colour has changed or it is dry

Press **Menu Select**.

Set to “72”.



After 10 seconds
(Setting ends automatically.)

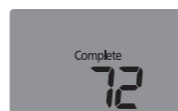

If burning is a concern.

1 Press **Menu Select** and set “◀” to “Quick”.



- Select “Quick” under “Pearl Rice” or “Jasmine Rice”.

2 Press **Keep Warm**. You will not hear a beep.

Press **Timer 1-2**. You will not hear a beep.

Press **Keep Warm**.

3 Press **Menu Select**.
Select “02”.



Press **Start**.

4 Press **Menu Select**.
Set to “So:Lo”.



After 10 seconds
(Setting ends automatically.)



To stop the buzzer sounding (end sound) during cooking, reheating and cleaning.

1 Press **Menu Select** and set “◀” to “Quick”.



- Select “Quick” under “Pearl Rice” or “Jasmine Rice”.

2 Press and hold down **Keep Warm**.
(for approximately 5 seconds)



- This change does not switch off the button sounds.

Specifications

Program		Approximate cooking time	Keep Warm Function*	Timer Setting Restriction	Cooking Capacity (Cup) () is for when other ingredients are added.	
					SR-FC108	SR-FC188
Pearl Rice Jasmine Rice	Delicious	50 min	○	From 60 min before done	0.5–5.5	1–10
	Regular	37 min	○	From 50 min before done	0.5–5.5	1–10
	Quick	19 min–33 min	○	—	0.5–5.5	1–10
	1-2Person	50 min	○	From 60 min before done	0.5–1.5	1–2.5
	Congee	Setting time 1 h–4 h	×	Cooking time + 1 min or more before done	0.5–0.75	0.5–1.5
	Casserole	50 min	×	—	1–3	2–6
	Brown Rice	1 h 35 min– 1 h 55 min	×	From 130 min before done	1–3 (1–2)	1–7 (1–5)
	Grains	45 min–55 min	×	From 60 min before done	0.5–4	1–8
Cake		Setting time 40 min–60 min	×	—	Dough Max 600 g	Dough Max 900 g
Steam		Setting time 1 min–60 min	×	—	Quantity of water 500 mL	Quantity of water 600 mL

* With “x”, the Warm Jar will switch automatically to the keep warm function, but we do not recommend this. (P. 13)

		SR-FC108	SR-FC188
Power source		220 V ~ 50 Hz	
Power consumption (Approx.)	Cooking	1100 W	1300 W
	Keeping warm	710 W (27.6 Wh* ¹)	650 W (32.8 Wh* ¹)
Rated capacity of the Inner Pan		3.0 L	5.0 L
Length of the Power Cord (Approx.)		1.0 m	
Weight (Approx.)		4.6 kg	5.7 kg
Size (Width × Depth × Height) (Approx.)		25.5 cm × 36.6 cm × 21.0 cm (40.2 cm* ²)	28.4 cm × 39.2 cm × 24.3 cm (45.6 cm* ²)

*¹ the power consumed per hour during the keep warm state. (Room temperature 20 °C, maximum amount of rice.)

*² the height with the Outer Lid open.

- Power consumption is the maximum instantaneous electric capacity.
- When the power is “Off”, the Warm Jar consumes approximately 1.6 W (plugged in state).
- This product was designed for Hong Kong.
It is not suitable for use in countries or regions of differing mains frequency or voltage. Moreover, after sales service is not available.

Checks	Check your well-used IH Electronic Warm Jar!	
	Have you noticed any of the following? <ul style="list-style-type: none"> ● The power plug and the power cord become abnormally hot. ● The power cord is damaged or power failure happens when the power cord is touched. ● The main body is deformed or is abnormally hot. ● Smoke emanates from the main body or a burning odour is detected. ● The main body is cracked, is loose or rattles. ● The fan in the bottom does not rotate while cooking. 	Stop using the Warm Jar <p>To prevent accidents, stop using the Warm Jar, remove the power plug, and ask your dealer to perform inspection.</p>

Panasonic Corporation

Web Site: <http://www.panasonic.com.hk>

© Panasonic Corporation 2018

使用說明書

IH 微型電腦飯煲 家用

1.0 L 型號 SR-FC108

1.8 L 型號 SR-FC188



本使用說明書全篇使用 SR-FC108 的圖解。

多謝購買 Panasonic 產品。

- 此產品的用途只限家庭使用。
- 使用產品前請仔細閱讀使用說明書以確保安全及正確使用。
- 請確保閱讀「安全注意事項」再使用(第2-5頁)。
- 請將保用證與使用說明書保存在一處安全地方。

附加保用證

目錄

檢查及預防措施

	頁
安全注意事項	2
使用注意事項	6
零件名稱/附件	7

日常使用

煮飯	8
正確使用程序	10
使用不同程序	11
烹調	12
保溫	13
●保溫/再加熱	
使用預約功能	14
●當目前時間有誤	

食譜

●粥/煲仔飯	15
●糙米飯/什穀米	16
●蛋糕/蒸	17

清洗

	清洗	18
●首次使用時及每次使用後		
●定期檢查		
●當微型電腦飯煲的潔淨有問題時		

詳細資料

我的微型電腦飯煲有故障嗎?	20
這是什麼意思?	21
下一步應該怎樣...	22
規格	26

安全注意事項

請確保按照以下說明

為防止使用者及他人造成意外或受傷，以及財產受損，請按照以下說明。

■ 以下圖表顯示錯誤操作可導致的損壞程度。

 **警告：** 表示嚴重傷亡。

 **注意：** 表示受傷風險或財產損壞。

■ 符號已分類並解釋如下。

 此符號表示禁止使用。

 此符號表示必須達到要符合的需求。

警告

-  ● 如電源線或電源插頭已損壞或電源插座與電源插頭的接口鬆脫，請勿使用產品。
(否則可能會導致觸電或因短路導致火災。)
→ 如供應電源線已損壞，必須用製造商或其服務代理商提供的特別電源線或配件更換。
- 請勿損壞電源線或電源插頭。
 - 嚴格禁止進行以下操作。
損毀、更改、觸摸或放置靠近加熱元件、強行彎曲、扭曲、拖曳、在尖銳物件拖曳、將重型物件放置在上、將電源線束成一紮、抓住電源線及拉扯電源線以移動產品。
(否則可能會因電源線和電源插頭破損而導致火災和觸電。)
- 請勿以濕手插入或拔掉電源插頭。
 - 處理電源插頭或開啟產品前請永遠確保手是乾燥的。
(否則可能會導致觸電或受傷。)
- 請勿在吸氣孔、排氣孔或隙縫間插入任何物件。
 - 特別是金屬物件例如引線或電線。
(否則可能會導致觸電或因操作故障導致受傷。)
- 請勿用水清洗本體、將產品浸入水中或讓水濺濕。
(否則可能會導致觸電或因短路導致火災。)
→ 如水濺入產品內請聯絡授權經銷商。
- 請勿自行更改、拆解或修理產品。
(否則可能會導致火災、觸電或受傷。)
→ 請聯絡授權經銷商查詢維修事宜。

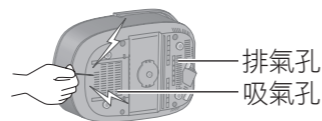

警告

-  ● 請勿使用產品於使用說明書記載以外的任何用途。
(否則可能會導致火災、燒傷、受傷或觸電。)
● 對於不當使用產品或未能遵守使用說明書，Panasonic 將不承擔任何責任。

- 請勿在使用中或剛使用後將臉靠近或用手觸摸蒸氣口和美味感應裝置。
 - 對兒童加強注意。
(否則可能會導致燒傷。)

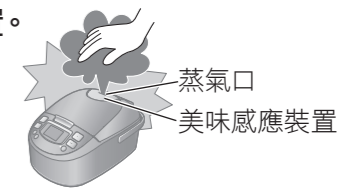

- 請勿放置任何東西在內鍋以阻擋蓋加熱板的孔。
(否則可能會蒸氣洩漏或食材噴出，導致燒傷或受傷。)

<嚴禁進行的烹調例子>

- 烹調盛載於膠袋內的材料或調味料。
- 使用鋁箔等直接蓋在食材上進行烹調。

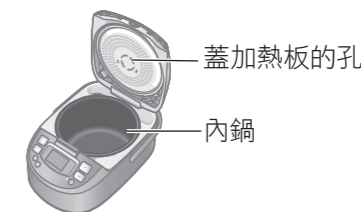

- 請勿在烹調時開啟外蓋或移動產品。
(否則可能會蒸氣洩漏或食材噴出，導致燒傷或受傷。)

- 請勿將水或其他液體潑灑在連接器 (如本體插頭) 上。
(否則可能會導致觸電或因短路導致火警。)

- 請勿讓任何人舔本體插頭。
 - 對兒童加強注意。
(否則可能會導致觸電或受傷。)

-  ● 本產品不適合供下列人士 (包括小孩) 使用：身體官能或心智能力退化者，或是經驗與使用知識缺乏者，除非有負責他們安全的人員在旁監督，或指示產品的使用方法，方可使用。請看管好兒童以免讓他們將產品當成玩具。
(否則可能會導致燒傷、受傷或觸電。)

- 只限使用規格為 10 安培及 220 伏特交流電的電源插座。
(將其他裝置插入相同的電源插座可能導致電力過熱而引起火災。)
● 只限使用規格至少為 10 安培的延長電線。

- 將本體插頭及電源插頭穩固地插入。
(否則可能會導致冒煙、火災或觸電。)

- 定期清潔電源插頭。
(弄髒的電源插頭可能會因濕氣及外物積聚而導致絕緣不足引起火災。)
→ 拔掉電源插頭，然後使用乾布擦拭。

安全注意事項

請確保按照以下說明

警告

- 如發生異常情況或故障請立即停止使用，並將電源插頭拔掉。
(否則可能會導致冒煙、火災或觸電。)
例如：發生異常情況或故障
 - 電源插頭及電源線異常發熱。
 - 電源線損毀或碰到電源線後發生間歇性斷電。
 - 本體變形或異常發熱。
 - 本體冒煙或發出焦味。
 - 本體破裂、鬆動或發出異常聲響。
 - 烹調時底部風扇不旋轉。→ 請即時聯絡授權經銷商進行檢查或維修。

- 慢慢合上外蓋直至喀噠一聲。
(為預防由蒸氣洩出或開啟外蓋而導致的燙傷或傷害。)
 - 為確保外蓋合上、請清除在上框、蓋加熱板的密封墊或外蓋的密封墊、內鍋的邊緣、開蓋按鈕周邊的外物例如米飯等。

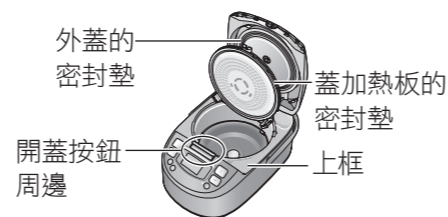

- 請將電源線遠離兒童。
 - 請勿讓電源線懸掛在放置產品的餐桌或工作檯邊緣。
(拖拽電源線可能導致產品從餐桌或工作桌上掉下而導致受傷。)

- 請將產品遠離兒童。
(否則可能會導致燒傷、受傷或觸電。)
 - 兒童對不正確使用電子產品而引發的危險是沒有意識的。



- 使用產品時請小心放置電源線以免絆倒。
(否則可能會導致受傷，或損壞電源線而引起火災或觸電。)

- 確保您使用接地電源插座。
 - 產品的電源插頭是為接地電源插座而設。
(使用無接地的電源插座可能因漏電導致故障或觸電。)

注意

- 請勿將電源插頭暴露在蒸氣中。
 - 電源插頭接上電源後，請勿將電源插頭暴露在蒸氣中。
(否則可能會導致觸電或因短路導致火災。)
 - 使用有拉桌的櫥櫃時，請在不會將電源插頭暴露在蒸氣中的情況使用產品。

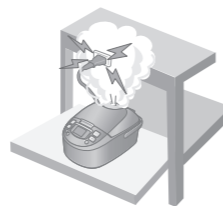

- 請勿使用非指定的內鍋及變形的內鍋。
(否則可能會因過熱或故障導致燙傷或受傷。)

- 使用中或使用後請勿觸摸加熱元件。
 - 美味感應裝置、蓋加熱板、內鍋及內鍋附近的金屬零件，例如上框等。
(否則可能會導致燒傷。)
 - 請用乾布或隔熱手套取出熱內鍋。



注意

- 移動產品時請勿觸摸開蓋按鈕。
(否則可能導致外蓋開啟而導致燙傷。)
- 請勿在以下地方使用產品。
 - 可讓水濺濕或靠近熱源的地方。
(否則可能會導致觸電、漏電或火災。)
 - 不平坦的表面或非耐熱的地毯上。
(否則可能會導致受傷、燙傷或火災。)
 - 靠近牆壁或傢俱。
(否則可能會導致變色、變形或損壞。)
 - 外蓋開啟的地方不能碰觸到周圍的物體，如牆壁或家具。
 - 鋁板或電子墊子上。
(鋁材料可能會產生熱力及引致冒煙或火災。)



- 內鍋沒有米或水的情況下請勿開啟電源。
(否則可能會導致燒傷。)
- 請勿使用此產品沒有指定可使用的電源線配件 (即指本體插頭及電源插頭)。
並且切勿將它轉換。
(否則可能會導致觸電、漏電或火災。)

- 拔掉電源插頭或本體插頭時請確保握住電源插頭或本體插頭。
(否則可能會導致觸電或短路引致火災。)

- 取出內鍋前或不使用產品時切記關掉電源，然後將電源插頭從電源插座拔掉。
(否則可能會導致燒傷、受傷、因絕緣退化而導致的觸電或短路引起火災。)

- 拔掉電源插頭然後允許產品完全冷卻才進行清洗及保存。
 - 產品未冷卻前請勿將它移動。
(觸摸加熱元件可能會導致燙傷。)

- 如在廚房架上等地方使用產品時，請確保蒸氣在封閉空間內可以向外散發。
(否則可能會導致變色或變形。)
 - 使用有拉桌的櫥櫃時，請確保拉桌全部拉出以防止上層架子暴露在蒸氣下。

- 欲使用滑動台時，使用台架的耐重強度為 10 kg 以上 (1.0 L 時) 或 13 kg 以上 (1.8 L 時) 的產品。
(這可能因產品掉下而導致燒傷或受傷。)

- 搬運產品時請提握手柄。
(否則可能會導致燒傷或受傷。)

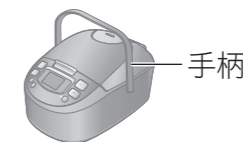

- 如您使用植入起搏器請向醫生查詢。
 - 此產品的操作可能影響您的起搏器。

使用期間電源中斷

- 包括電源插頭已拔掉，或使用電源斷路器時絆倒。
- 如遇瞬間電力中斷，產品將返回電源停止前的狀態。
- 如電源中斷了很長時間，電源恢復後產品可能返回以下狀態。
 - 烹調狀態：繼續烹調。
 - 保溫狀態：繼續將米飯保溫。
 - 米飯可能以不理想的方式烹調。

* 如預約設定時間已過，煮飯便會即時開始。米飯可能未在設定時間內完成烹調。若要瞭解「預約設定限制」的進一步詳情，請參考第 26 頁。

使用注意事項

若要長時間保持產品在良好情況，請留意以下事項。

關於微型電腦飯煲

- 請勿在電磁爐上使用微型電腦飯煲。
(否則會損壞電磁爐或微型電腦飯煲。)
- 請勿在直接暴曬陽光的地方下使用微型電腦飯煲。
(否則可能會導致變色。)
- 請勿在微型電腦飯煲底部(吸氣孔及排氣孔)受到阻塞的地方(例如地毯、膠袋、鋁箔及布料等)下使用微型電腦飯煲。
(否則會損壞微型電腦飯煲。)
- 定期檢查微型電腦飯煲底部的吸氣孔及排氣孔，並且清除所有灰塵。(第19頁)
- 請勿在戶外使用微型電腦飯煲。
(不穩定電源供應可能會導致微型電腦飯煲發生故障。)
- 使用微型電腦飯煲時請勿覆蓋其頂部。
●洗碗布等。
(否則可能會因蒸氣悶住，使外蓋和按鈕變形而無法操作。)

- 有異物如米飯或污垢阻塞的情況下，請勿使用微型電腦飯煲。
(否則可能會顯示錯誤訊息，米被煮焦或烹調出現問題。)
(否則烹調時可能會出現蒸氣外漏而損傷本體。)

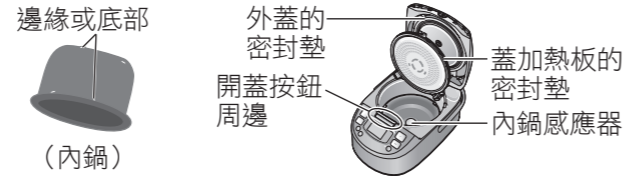

- 請勿將微型電腦飯煲放置在容易受電磁場影響的裝置附近。
●無線電、電視、助聽器等。
(有可能聽到噪音或減低音量。)
●IC卡/銀行卡等。
(儲存在卡上的記錄可能會遺失或損壞。)
- 請勿帶磁石物件靠近微型電腦飯煲。
(否則可能會導致故障。)

關於內鍋

- 請勿在微型電腦飯煲以外使用內鍋。

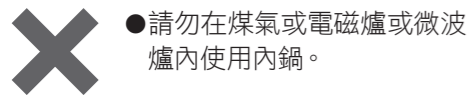

- 請勿將內鍋與硬物件撞擊。

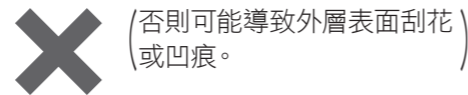

- 留意以下情況以避免削去或刮花內鍋塗層。

準備烹調時

- 請勿使用攪拌器或其他工具洗米。
- 請勿使用金屬網漏等物件接觸內鍋塗層。

煮好米飯後

- 請勿在內鍋攪拌鹽或香鬆等。
- 請勿將醋放入內鍋中的米飯(製作壽司等食物)。
- 請勿使用金屬杓子(烹調粥等食物)。
- 請勿敲打內鍋(盛飯時)。

清洗時(第18-19頁)

- 請勿將內鍋用作為洗碗工具。請勿將湯匙或其他餐具放入內鍋中。
- 使用調味烹調後，請勿將食物留在內鍋中。
→烹調煲仔飯後，請盡快清除內鍋中的食物然後進行清洗。
- 請勿使用乾碗機或洗碗機/烘乾機進行清洗。
- 請勿在清洗後將內鍋放在其他餐具上烘乾。
- 請勿使用浸入光劑的砂紙、金屬清潔球、尼龍清潔球等清洗或擦洗內鍋。
→使用軟海棉進行清洗。
請勿使用百潔布進行清洗。

附註

- 以下情況不會影響其性能或健康。
[外層表面] 淺的刮痕、細小凹痕或碰撞。
[內層表面] 內鍋塗層剝落。
→ 如內鍋變形或您擔心其狀況，是可以購買新的內鍋。

零件名稱/附件

■首次使用微型電腦飯煲前，請清洗附件、內鍋、蓋加熱板及美味感應裝置。(第18-19頁)

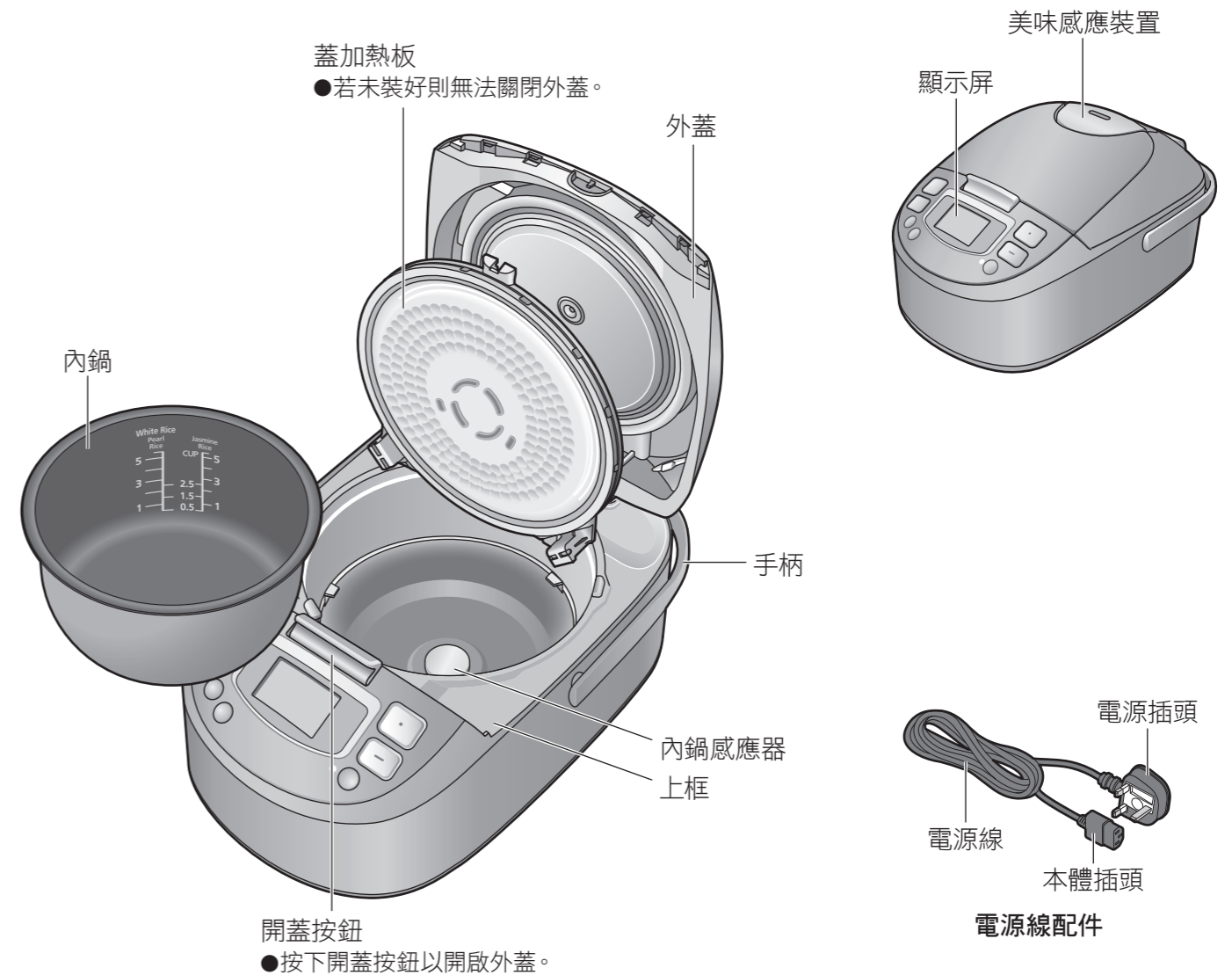

附件



量杯(1)
(約180 mL)
●所有米種都共通。

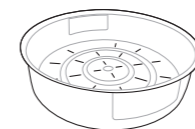

蒸籠(1)



飯勺(1)



粥勺(1)

附註

- 有關視覺受損人士的協助，「Start(開始)」及「Cancel/Off(取消/關)」按鈕附有「●」及「■」的凸起部份。

煮飯

洗米然後加水

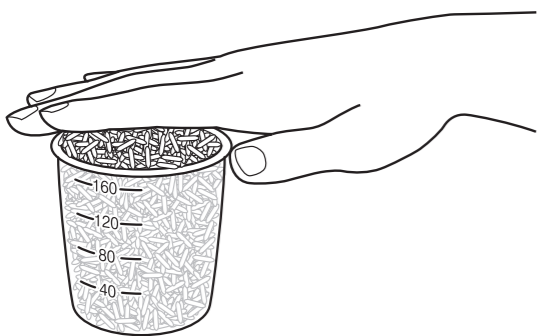

1 量米

- 用附贈的量杯量米至相應的刻度。
(大約 180 mL / 量杯)

2 洗米

- ① 首先加大量的水、攪拌，然後迅速將水倒掉。
- ② 重複此步驟 2-5 次，每次洗米時輕輕攪拌。
(烹調的水可以保持小許白色。)
- ③ 洗米後放進內鍋。
(可以在內鍋洗米。)

預防措施

- 請勿讓米留在網漏內。
(米粒可能斷開，導致烹調時米飯黏住或產生飯焦。)



3 加水

- 加水至所要烹調程序的位置(水位線)。(第 10 頁)
(請確保內鍋在平面上然後檢查兩側的水位線位置。)
- 根據米量並加水到相應的位置。
按您的口味由水位線調整水量約 1 至 2 mm。
(加入過多水量會造成食材噴出以及炊飯時間增長，
導致口味變差。)
- 新收割的米可因應而減去小量水。
- 要煮出較硬的米飯，可加入比水位顯示較少一點的水量，要煮出較軟的米飯，可加入比水位顯示較多一點的水量。
- 請確保米已水平放置。
- 無須將米浸泡。
(按下「Start (開始)」按鈕時，水將會自動吸取。)

選擇「Jasmine Rice (茉莉米) /
Delicious (美味模式)」烹調使用 3 量杯米

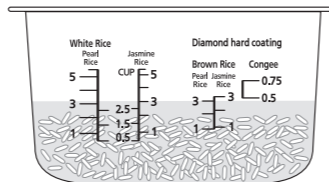

圖表中的內鍋是 1.0 L 型號。

設定程序

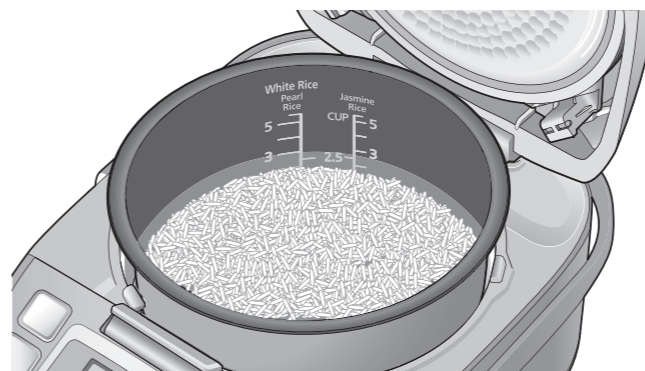

4 將內鍋放置在微型電腦飯煲內

- 清除任何在內鍋外的水漬。

5 合上外蓋

- 請確認蓋加熱板和美味感應裝置已裝好。
(第 18-19 頁)

烹調

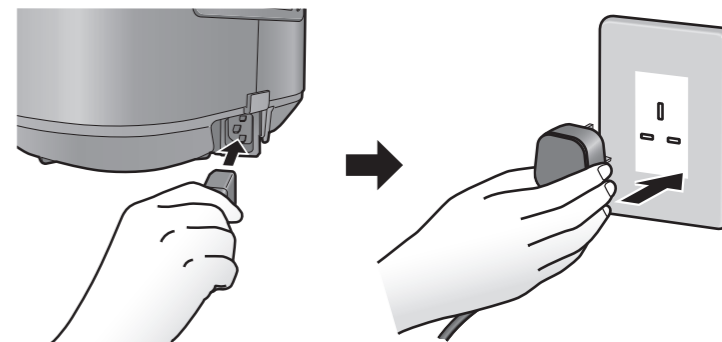

6 插入電源插頭

- 請首先將本體插頭連接本體然後連接至電源插頭。
請確保兩個插頭已確實連接。

7 檢查程序然後按下「Start (開始)」按鈕

在購買時，預設值已將程序設定為「Jasmine Rice (茉莉米) / Delicious (美味模式)」。
要改變預設值時(第 11 頁)

按下 Start 開始。
烹調開始。



- 當烹調完成鈴聲提示時，蒸煮步驟已完成。將飯即時翻鬆。
(可蒸發多餘水份。)
- 會自動保溫。(第 13 頁)

烹調美味米飯的 三項原則



正確量水及量米。



輕輕洗米。

過度用力洗米可能導致米粒斷開、
導致烹調時米飯黏住或產生飯焦。



使用適合的水。

我們建議使用自來水或
過濾自來水。

- 使用含鹼水 (pH 值高於 9)
可能導致米飯稍軟或變黃。
- 使用硬礦泉水
(有 100 或以上硬度)
可能導致米飯乾燥或硬。



注意事項!

- 如可以，選擇最近製成的米。
- 開啟袋裝米後，請即時使用。
- 將米存放在雪櫃內。

正確使用程序

程序	內鍋的水位線	烹調時間 (大約)
最佳味道	Delicious (美味模式) 此為預設模式。	White Rice (Pearl Rice / Jasmine Rice) 50 分鐘
標準烹調	Regular (標準)	White Rice (Pearl Rice / Jasmine Rice) 37 分鐘
快速烹調	Quick (快速煮飯) 米飯將會稍微變硬。您可以將米浸泡使它軟化再烹調。	White Rice (Pearl Rice / Jasmine Rice) 19 分鐘–33 分鐘
烹調少量米飯	1-2Person (少量) 1.0 L 型號 (0.5 至 1.5 量杯) 1.8 L 型號 (1 至 2.5 量杯)	White Rice (Pearl Rice / Jasmine Rice) 50 分鐘
烹調粥	Congee (粥) 1.0 L 型號 (0.5 至 0.75 量杯) 1.8 L 型號 (0.5 至 1.5 量杯)	Congee 設定時間 1 小時–4 小時
烹調煲仔飯	Casserole (煲仔飯)	White Rice (Pearl Rice / Jasmine Rice) 50 分鐘
烹調糙米飯	Brown Rice (糙米飯)	Brown Rice (Pearl Rice / Jasmine Rice) 1 小時 35 分鐘– 1 小時 55 分鐘
烹調不同什穀米	Grains (什穀米)	White Rice* (Pearl Rice / Jasmine Rice) 45 分鐘–55 分鐘
焗蛋糕	Cake (蛋糕)	— 設定時間 40 分鐘–60 分鐘
蒸	Steam (蒸)	— 設定時間 1 分鐘–60 分鐘

* 調整水量以適應什穀米的種類及您的口味。

- White Rice (白米) 或 Brown Rice (糙米飯) 有兩個水位線：「Pearl Rice (珍珠米)」和「Jasmine Rice (茉莉米)」。選擇正確的水位線以適應煮飯類型。
- 烹調的實際時間會根據米量、水量、電壓、室溫、水溫、米質的不同而變化。
- 「Casserole (煲仔飯)」、「Grains (什穀米)」的烹調時間會根據使用的食材而變化。

● 請勿將糙米與白米一起烹調。(烹調效果可能未如理想。)

使用不同程序

● 用於「Cake (蛋糕)」及「Steam (蒸)」程序時 (第 12 頁)

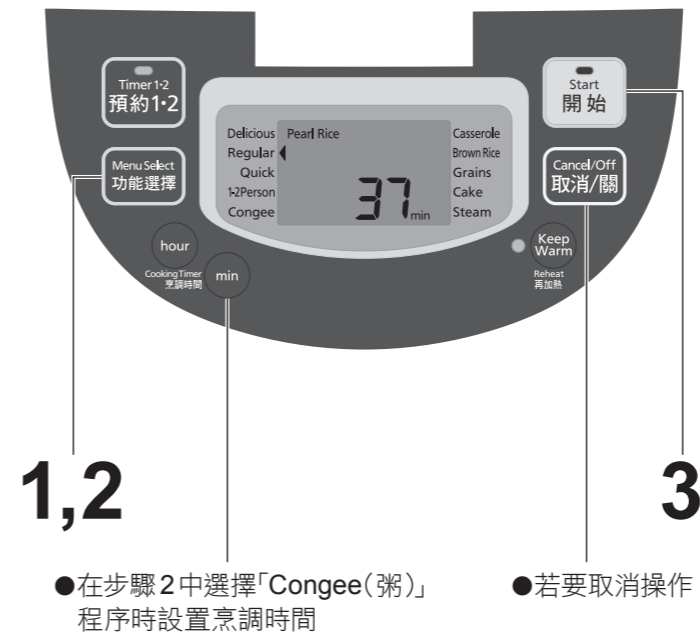

1 選擇一個米種

按下 **Menu Select 功能選擇**。

- 每次按下「Menu Select (功能選擇)」按鈕時，「◀」位置會移動，且「◀」跑過一個循環後會在「Jasmine Rice (茉莉米)」和「Pearl Rice (珍珠米)」之間轉換。

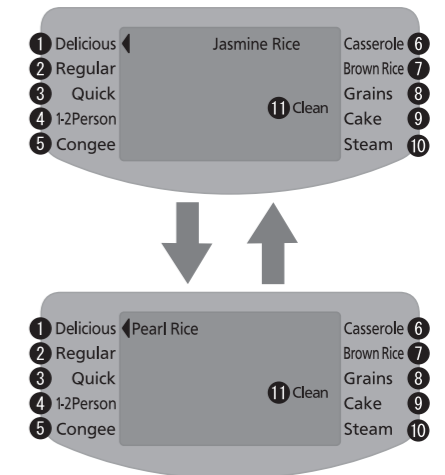

2 選擇一個功能

按下 **Menu Select 功能選擇**，將「◀」設定為某個功能。

- 選擇「Congee (粥)」程序時，設定烹調時間。

按下 **min**。

可允許烹調時間設定	單位
1 小時–4 小時	30 分鐘

3 按下「Start (開始)」按鈕

閃動
按下 **Start 開始**。

烹調開始。

- 當烹調完成鈴聲提示時，蒸煮步驟已完成。將飯即時翻鬆。(可蒸發多餘水份。)
- 會自動保溫。(第 13 頁)
- 連續烹調粥時，請在取出內鍋並打開外蓋的狀態下，將微型電腦飯煲冷卻 5 分鐘以上再使用。

我需要每次選擇程序嗎？

- 在「Pearl Rice (珍珠米)」或「Jasmine Rice (茉莉米)」下選擇「Delicious (美味模式)」及「Regular (標準)」程序已儲存。至於其他程序，以下操作允許您選擇最近使用程序。(無法叫出「Cake (蛋糕)」及「Steam (蒸)」程序。)

1 長按 **Menu Select 功能選擇**
(大約 2 秒)

- 當您按下按鈕您將會聽到「嗶」一聲，不過繼續按住。您將會聽到第二個「嗶」一聲，然後最近使用程序將會顯示。

2 按下 **Start 開始** 閃動

附註

- 「Clean (清洗)」會於選擇時出現。
- 為了讓選擇功能時更容易分辨 (例如「Menu Select (功能選擇)」按鈕顯示為「Jasmine Rice (茉莉米) / Delicious (美味模式)」)，嗶一聲已變更為「嗶嗶」。
- 顯示屏幕根據已選烹調程序變更。請注意「Quick (快速煮飯)」、「Brown Rice (糙米飯)」及「Grains (什穀米)」程序，微型電腦飯煲將顯示目前時間直至 10 分鐘才表示烹調完成。之後將轉換顯示時間直至烹調完成。

烹調

烹調

- 選擇一個烹調功能
按下 **Menu Select 功能選擇**，將「▶」設定為某個烹調功能。



焗蛋糕：「Cake (蛋糕)」
蒸：「Steam (蒸)」

- 設定烹調時間
按下 **min**。

程序	可允許烹調時間設定	單位
Cake (蛋糕)	40分鐘–60分鐘	1分鐘
Steam (蒸)	1分鐘–60分鐘	1分鐘

* 當微型電腦飯煲開始釋放蒸氣，蒸氣倒數設定時間便開始。

- 按下「Start (開始)」按鈕

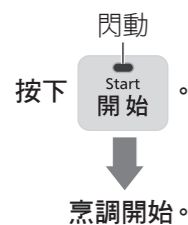

● 當烹調完成後，微型電腦飯煲則自動轉換至保溫功能，所以請關閉微型電腦飯煲。

按下 **Cancel/Off 取消/關**。

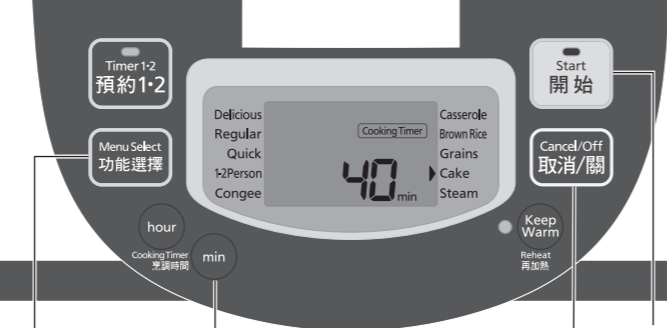

- 1
- 2
- 3 ●若要重設操作

附註

可用容量

程序	1.0 L	1.8 L
Cake (蛋糕)	麵糰上限 600 g	麵糰上限 900 g
Steam (蒸)	水量 500 mL	水量 600 mL

如何使用蒸籠

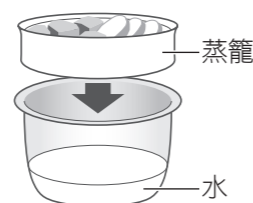

預防措施

蒸餸時...

- 請勿讓食材阻塞蓋加熱板的孔。

烹調後...

- 請勿使用保溫功能。
(這可能導致引發氣味，變質或蓋加熱板生鏽。)
- 烹調後，外蓋的內側和內鍋周圍都很燙，取出煮熟的食物時請小心。
- 烹調後打開外蓋時，水滴可能從蓋加熱板滴到上框。
→ 用擰乾水分的濕毛巾擦拭。
- 經常清洗蓋加熱板及美味感應裝置。
擦拭外蓋的內部表面、美味感應裝置的配件部分及密封墊。
當烹調多肉材料時，脂肪及蛋白質可弄髒蓋加熱板及外蓋的內部表面。
(這可能導致引發氣味，變質或蓋加熱板生鏽。)

保溫

保溫 (自動)

- 完成烹調後，所有程序隨即自動轉換為保溫功能。
(完成烹調後請即時將米飯翻鬆。)

- 若要從保溫狀態再加熱
- 若要回到保溫狀態

● 若要關掉保溫功能
按下 **Cancel/Off 取消/關** 然後拔掉電源插頭。

	●Delicious (美味模式) ●1-2Person (少量)	●Regular (標準)	●Quick (快速煮飯)
●Congee (粥) 如對粥進行保溫，有可能變稠、變糊。			
●Casserole (煲仔飯) 使用保溫功能也可能導致蓋加熱板生鏽，嚴重影響米飯味道。			
●Brown Rice (糙米飯) ●Grains (什穀米) 使用保溫功能也可能導致蓋加熱板生鏽，嚴重影響米飯味道。			
●Cake (蛋糕) ●Steam (蒸) 這可能導致引發氣味，變質或蓋加熱板生鏽。			

預防措施

- 請勿使用保溫功能超過 12 小時。
(以免造成米飯產生異味、泛黃、乾硬等。)
- 讓米飯留在微型電腦飯煲內的時候，請勿取消保溫功能或拔掉電源插頭。
(以免造成水滴冷凝或產生異味。)
- 使用保溫功能時請將飯勺從微型電腦飯煲取出。
(以免造成異味。)

附註

- 保溫時間達至 23 小時是以 1 小時為單位顯示 (顯示「0」即代表小於 1 小時)。超過 24 小時後雖然會持續保溫，但顯示會變成目前時間。
- 若未按下「Cancel/Off (取消/關)」按鈕即拔掉電源插頭，則下次插上電源插頭時，會再開始進行保溫。

再加熱 (手動)

- 從保溫狀態加熱至高溫度的米飯。

- 在保溫狀態下
翻鬆米飯

附註

- 再加熱無法在以下情況下使用。
 - 當米飯已冷卻 (鈴聲提示 4 次)。
 - 保溫功能並未啟動。
- 加熱超過 2 次將會嚴重影響米飯味道。

- 按下「Keep Warm (保溫)」[Reheat (再加熱)] 按鈕

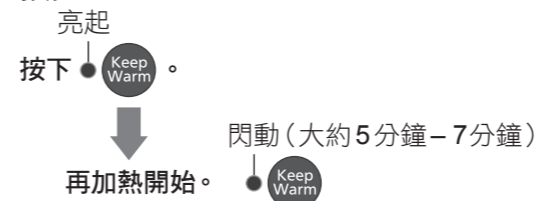

- 當鈴聲提示，即時翻鬆米飯。
米飯即可享用。

使用預約功能



- 可以設定2個預約時間。(設定將儲存直至變更。)
- 您可能覺得保存經常使用的時間較方便，例如使用「Timer 1 (預約1)」供早餐提醒而「Timer 2 (預約2)」供晚餐提醒。

例如：設定為早上7:30

1 檢查目前時間是正確

- 如時間不正確，請按以下右邊步驟設定。

2 檢查程序

(設定為想要程序。第11頁的步驟1-2)

- 「Congee (粥)」程序使用預約時，首先設置烹調時間，然後按下「Timer 1-2 (預約1-2)」按鈕。在預約狀態下，按下「min(分)」按鈕以確認設定的烹調時間。

3 選擇「Timer 1 (預約1)」或「Timer 2 (預約2)」

按下「Timer 1-2 預約1-2」。

- 每個按鈕動作將變更選擇。

Timer 1 ↔ Timer 2



閃動

4 設定完成米飯烹調時間

hour 向前 (單位為每1小時)

min 向前 (單位為每10分鐘)

- 長按按鈕以加快循環時間。



閃動

5 按下「Start (開始)」按鈕

閃動
按下「Start 開始」。

亮起
熄滅
設定結束。

- 烹調完成鈴聲提示時，蒸煮步驟已完成。將飯即時翻鬆。(可蒸發多餘水份。)
- 會自動保溫。(第13頁)

當目前時間有誤

- 顯示時間為24小時時鐘格式。

1 將電源插頭穩固地插入

2 按住 hour 或 min 1秒以上

- 聽到「嗶」聲時放開手指。



閃動

3 設定時間

hour 向前 (單位為每1小時)

min 向前 (單位為每1分鐘)

- 長按按鈕以加快循環時間。



閃動停止時，代表時間已設定。

- 時間無法在以下情況設定，例如正在使用烹調/保溫狀態/預約/清洗功能設定。
- 鋰電池不足時，拔掉電源插頭將導致遺失資料，例如目前時間及預約時間的設定。(第20頁)
- 鋰電池已固定在本體內所以無法由顧客自行更換。若要更換鋰電池，請向您購買微型電腦飯煲的經銷商或服務櫃台查詢。

■ 若要在完成預約設定後參考目前時間。

亮起
按下「Timer 1-2 預約1-2」。

- 長按即可顯示。

預防措施 ●請勿設定13小時以上(水溫高時8小時以上)的預約。(以免造成米發酵、產生異味。)

附註 ●如預約設定的時間不足，預約將不允許設定，烹調則即時開始。(參考第26頁的「預約設定限制」。)

- 預約無法使用「Quick (快速煮飯)」、「Casserole (煲仔飯)」、「Cake (蛋糕)」或「Steam (蒸)」。
- 如使用預約烹調，則不會顯示剩餘完成時間。
- 如使用預約烹調，米可能吸收過量水分。這可能導致米飯變軟或產生飯焦。→ 米飯太軟的話，請稍微減少水量。(減少至水位線下方大約1至2 mm處。)

粥/煲仔飯

皮蛋瘦肉粥



材料(2-3人份量)：

白米..... ½量杯
上湯(冷卻了的)..... 5量杯
皮蛋..... 1個
熟瘦肉..... 125 g

調味：

鹽..... 1茶匙
胡椒粉..... 少許
麻油..... 少許

方法：

- 1 將熟瘦肉醃好，浸在鹽中1小時然後切成細片。將皮蛋切成小方塊，然後備用。
- 2 洗米後倒進內鍋，再加入肉羹然後合上外蓋。

雞肉及芋頭煲仔飯



材料(4-6人份量)：

白米..... 3量杯
雞肉(已切粒)..... 200 g
乾冬菇(已浸泡及切片)..... 5件
芋頭(已切粒)..... 100 g
蝦米乾(已浸泡)..... 40 g
黑木耳(已浸泡及切碎)..... 少件

滷汁：

A
淡醬油..... 1茶匙
老抽醬油..... ½茶匙
糖..... 1茶匙
鹽..... ½茶匙
澱粉..... 1½茶匙

醬料：

B
淡醬油..... 1湯匙
老抽醬油..... 1湯匙
糖..... ½湯匙
麻油..... ½湯匙

重要資訊：

- 加入材料不能超過最高 White Rice (白米)的水位線。
- 烹調時請勿打開外蓋。(可影響烹調效果。)

型號	米量(杯*)
1.0 L	1-3
1.8 L	2-6

*附件中之量杯。

- 3 選擇程序然後設定烹調時間為1小時30分鐘。

功能選擇	Pearl Rice (珍珠米) / Jasmine Rice (茉莉米) Congee (粥)
------	--

- 4 按下「Start (開始)」按鈕。
- 5 當鈴聲提示後按下「Cancel/Off (取消/關)」按鈕，打開外蓋*，將皮蛋及瘦肉加入內鍋後合上外蓋。
*打開外蓋時，請注意食材正處於高溫。
- 6 選擇程序然後設定烹調時間為1小時。

功能選擇	Pearl Rice (珍珠米) / Jasmine Rice (茉莉米) Congee (粥)
------	--

- 7 按下「Start (開始)」按鈕。
- 8 當鈴聲提示後，於粥內加入調味料後即可享用。

方法：

- 1 用A將雞肉調味。
- 2 將切粒芋頭炸至金黃色、洗淨然後備用。
- 3 洗白米後放入內鍋，加水至「水位線：White Rice (Pearl Rice / Jasmine Rice) 3」。然後將1、2及其他材料平鋪在白米上，合上外蓋。(不要攪動。)

- 4 選擇程序。

功能選擇	Pearl Rice (珍珠米) / Jasmine Rice (茉莉米) Casserole (煲仔飯)
------	---

- 5 按下「Start (開始)」按鈕。
- 6 當鈴聲提示後，加入B然後即時攪拌翻鬆米飯。

糙米飯／什穀米

糙米飯



材料(4-6人份量)：
 糙米 3量杯
 白芝麻 少量
 黑芝麻 少量

方法：
 ① 輕輕洗糙米然後清除碎粒及外殼。
 ② 加水至「水位線: Brown Rice (Pearl Rice / Jasmine Rice) 3」然後合上外蓋。
 ③ 選擇程序。

功能選擇	Pearl Rice (珍珠米) / Jasmine Rice (茉莉米)
	Brown Rice (糙米飯)

④ 按下「Start (開始)」按鈕。
 ⑤ 當鈴聲提示後，翻鬆米飯。
 ⑥ 放在碟上然後灑少許黑白芝麻。

用其他材料烹調時(菜肉等)

- 加入其他材料前量水。
- 煮飯需時很長，建議加入硬材料例如荳類等。如您想加入乾材料，請確保它已浸泡。
- 每量杯米不應加入超過 75 g 其他材料。
- 將材料切件平鋪在飯上，免攪動。
 如您將飯與材料攪動，烹調效果可能受影響。

五穀米



材料(4-6人份量)：
 白米 3量杯
 五穀米 30 g

方法：
 ① 洗白米然後加水至「水位線: White Rice (Pearl Rice / Jasmine Rice) 3」。
 ② 輕輕洗五穀米然後放上 ①。
 ③ 再多加 30 mL 的水*，然後合上外蓋。
 * 可根據五穀米的種類和個人喜好適當調整水量。

④ 選擇程序。

功能選擇	Pearl Rice (珍珠米) / Jasmine Rice (茉莉米)
	Grains (什穀米)

⑤ 按下「Start (開始)」按鈕。
 ⑥ 當鈴聲提示後，翻鬆米飯。
 ⑦ 上碟後即可享用。

烹調五穀米時...

- 如果想要加入豆類或乾貨，例如雲耳菇，請確保它已浸泡。
- 在米粒中加入其它穀類的比例為 10% 或以下。
 (如果加入過多其它穀類，米就無法順利烹調。)
- 如果想將五穀米烹調軟一點，就多加些水或事先浸水。

蛋糕／蒸

蛋糕



材料(4-6人份量)：
 牛油或沙律油 少量
 薄煎餅混料 200 g
 雞蛋 2個
 豆奶 100 mL
 沙律油 3湯匙
 葡萄乾 70 g
 (或者您可用其他乾果代替。)

方法：
 ① 輕輕用牛油或沙律油塗抹內鍋。
 ② 將材料混合直至質感順滑。
 (請勿在內鍋中混合。)

③ 將 ② 倒入內鍋中然後合上外蓋。
 ④ 選擇程序然後設定烹調時間為 40 分鐘。

功能選擇	Cake (蛋糕)
------	-----------

⑤ 按下「Start (開始)」按鈕。
 ⑥ 當鈴聲提示後，將內鍋從微型電腦飯煲移走然後倒轉取出蛋糕。接著讓它在碟上或鐵絲網上冷卻。

* 如果您的型號為 1.8 L，建議您用 1.5 倍的材料，並設定烹調時間為 60 分鐘，讓蛋糕膨脹效果更佳。

金華火腿小棠菜



材料(4-6人份量)：
 小棠菜 100 g
 醃肉(金華火腿) 35 g

方法：
 ① 將小棠菜切斷成塊然後洗淨。將醃肉切片然後備用。
 ② 將切好的小棠菜放在碟上排層，再將醃肉切片置頂(嘗試用含脂肪的肥肉)。
 ③ 將 2.5 量杯水到入內鍋。

④ 裝好蒸籠，將 ② 放在上面然後合上外蓋。
 ⑤ 選擇程序然後設定烹調時間為 13 分鐘。

功能選擇	Steam (蒸)
------	-----------

⑥ 按下「Start (開始)」按鈕。

附註：
 如沒有小棠菜，可用白菜心代替。

預防措施

- 請勿讓食材阻塞蓋加熱板的孔。

清洗

- 清洗時，拔掉電源插頭然後確保本體已冷卻。
- 本體和蓋加熱板的密封墊不能拆下。請勿勉強拉扯或使用尖銳物件穿刺。(可能導致變形、剝落或損壞。)
- 清洗後，用乾布擦拭。

首次使用時及每次使用後

- 拆除配件後，用軟海棉清洗。

*欲使用清潔劑時，請確認清潔劑的注意事項。



- 煲仔飯等加入調味料後，即時清洗。(因為會引發異味、變質或生銹。)

<請勿使用以下東西>

金屬擦及滲入磨沙料的尼龍擦等。

請勿使用百潔布進行清洗。

揮發油、稀釋劑、擦亮劑、漂白劑、抗菌劑酒精等。

乾碗機或洗碗機 / 烘乾機



內鍋(第6頁)/飯勺/粥勺/蒸籠

用溫和清潔劑清洗。

預防措施

- 請勿將內鍋用作為洗碗工具。(這樣可能削去內鍋塗層。)



外蓋的內部表面/密封墊

用擰乾水分的濕毛巾擦拭。

- 拆卸美味感應裝置然後擦拭外蓋的內部表面、美味感應裝置的配件部分及密封墊。

附註

- 加水或炊煮糙米等時，會更容易附著污垢。

蓋加熱板

拆下後使用溫和清潔劑清洗。

- 去除密封墊部的米粒等異物。

■ 拆除時

抓住兩側的凸耳，朝自己方向拉，拉出突起部。

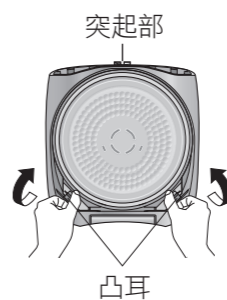

■ 安裝時

- ① 將蓋加熱板的突起部插入上部的凹槽。
- ② 將凸耳(兩側)壓進本體(外蓋)直至喀噠一聲。

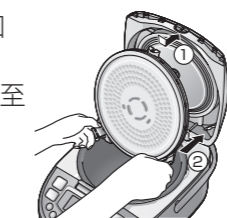

預防措施

- 使用調味料(煲仔飯等)或烘烤蛋糕後，請即時清洗。(因為會引發異味、變質或生銹。)

內鍋感應器

用擰乾水分的濕毛巾擦拭。

- 如污垢很難清除，用一點溫和清潔劑在尼龍擦然後輕輕擦拭。

附註

- 如有污垢時使用內鍋感應器可能導致米飯燒焦或以不理想方式烹調。

美味感應裝置

取出並沖洗乾淨。

- 水珠和污垢容易滯留在美味感應裝置內，所以每次使用後請清洗乾淨。(因為這可能會造成異味或裝置腐壞。)

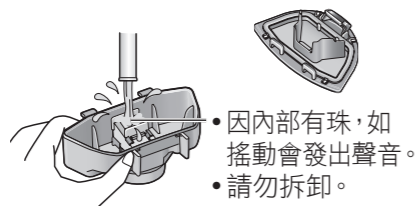

■ 拆除時

- ① 向上拉以拆除。
- ② 朝箭頭「⇨」方向拆除桿打開。

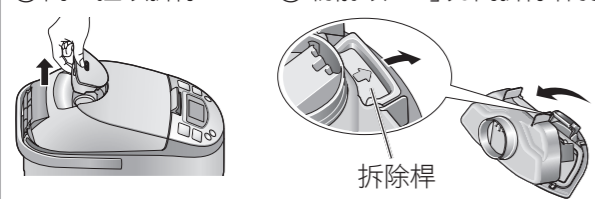

■ 安裝時(拆除時的相反方向。)

- ① 插入拉桿並將拆除桿關牢固，直到聽到「咔嚓」聲。
- ② 插進外蓋。(確保已穩固放回原位。)

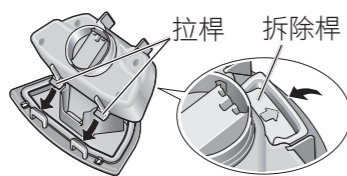

預防措施

- 請勿拆除密封墊。(這可能引致蒸氣洩漏。)
- 如密封墊脫落，確保沿著槽安裝。

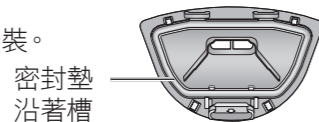

上框

用擰乾水分的濕毛巾擦拭。

- 去除開蓋按鈕周邊的米粒等異物。

預防措施

- 請勿將水倒入進行清洗。

定期檢查

- 大約每月檢查一次，如有灰塵請擦拭!

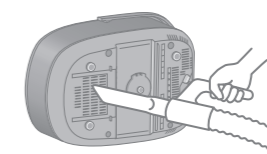

微型電腦飯煲底部
(吸氣孔/排氣孔)

用吸塵器吸除垃圾及異物等。

當微型電腦飯煲的潔淨有問題時

清洗功能

如很難清除氣味或污垢無法從蓋加熱板或蒸氣口中清除...

準備工作

- ① 將水倒進內鍋。
(1.0 L型號，「Pearl Rice/Jasmine Rice」水位線：3-4)
(1.8 L型號，「Pearl Rice/Jasmine Rice」水位線：6-8)
- ② 把內鍋放入本體並關上外蓋。

1 顯示「Clean (清洗)」

按下 Menu Select 功能選擇。

- 「Clean (清洗)」會於選擇時出現。



2 按下「Start (開始)」按鈕

閃動
按下 Start 開始。

清洗功能開始。

3 大約45分鐘後當蜂鳴器響時， 按下「Cancel/Off (取消/關)」按鈕

按下 Cancel/Off 取消/關。

- 等待內鍋裡的熱水冷卻後，清洗內鍋、蓋加熱板、美味感應裝置。

附註

- 可能無法完全去除氣味或污垢。







我的微型電腦飯煲有故障嗎？

檢查以下事項再要求維修。

症狀	在此檢查！	頁
烹調狀態 ● 殘餘時間的顯示停止不變。 ● 烹調時間比預期更長。	● 如不斷烹調米飯，烹調時間可能會較長（可能延長 45 分鐘）。 ● 內鍋的水量太多了嗎？ 如水量太多，烹調時間可能會變長（最長可達 15 分鐘）。	— —
	● 米飯黏在蓋加熱板的密封墊、外蓋的密封墊或內鍋邊緣？ ● 您是否有每次清洗蓋加熱板然後正確裝好？ ● 內鍋是否有變形？ → 如內鍋變形，請購買新的內鍋。 ● 蓋加熱板的密封墊或外蓋的密封墊是否有變形、剝落、破損？ → 蒸氣漏出時，請洽詢您購買微型電腦飯煲的經銷商。 ● 是否慢慢合上外蓋直至喀噠一聲？	— 19 — —
蒸氣從其他部分散發，不是從蒸氣口散發。	● 呼呼聲…散熱用的風扇操作聲。 ● 高調聲…IH 聲（感應加熱）。 保溫時，有時您可能會聽到這個聲音。 ● 嘶嘶聲…蒸氣噴出聲。 打開／合上外蓋時 ● 卡嗒聲…美味感應裝置的珠滾動時發出的聲音。	— — — —
烹調／保溫狀態 微型電腦飯煲產生聲響。	● 目前時間準確嗎？（顯示時間為 24 小時時鐘格式。） ● 預約是否設定在「預約設定限制」以外？	14 26
即使使用了預約烹調仍然立即開始。	● 使用預約時，烹調開始前米已浸泡，所以烹調開始後浸泡時間會較短。因此，烹調開始時間可能會稍微比預期晚一點。	—
預約 我已設定預約但烹調無法開始。	● 目前時間準確嗎？（顯示時間為 24 小時時鐘格式。） ● 您是否有按下「Start（開始）」按鈕？ ● 預約是否設定在「預約設定限制」以外？	14 14 26
米飯在預約設定的時間未煮好。	● 按鈕操作無法在以下情況運作，例如正在使用烹調／保溫狀態／預約／清洗功能設定。 → 按下「Cancel/Off（取消／關）」按鈕。	—
按鈕操作無法運作。	● 是否關掉了保溫功能？ ● 米飯冷卻了嗎？（鈴聲將會提示 4 次。） 如溫度是 50 °C 或更低則無法加熱。	— —
「Keep Warm（保溫）」 「Reheat（再加熱）」 按鈕沒有回應。	● 鋰電池不足。 雖然無法記憶目前時間和預約時間，但不影響炊飯和保溫的功能。 要預約炊飯時，請每次調整目前時間。 鋰電池已固定在本體內所以無法由顧客自行更換。 → 若要更換鋰電池，請向您購買微型電腦飯煲的經銷商或服務櫃台查詢。	—
其他問題 插入電源插頭時總是顯示「7:30」。	● 插入或拔掉電源插頭時，有時小火花可能會出現。這是一種正常現象，尤其是 IH（感應加熱）技術，不屬於故障。	—
電源插頭出現火花。		

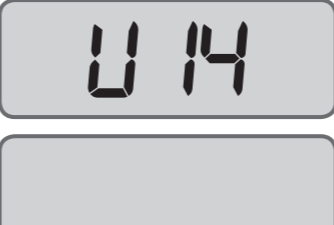
■ 如您不小心將水或米加入本體內，請拔掉電源插頭然後聯絡經銷商。

這是什麼意思？

錯誤訊息	在此檢查！
	● 內鍋放置正確？ ① 將內鍋重新放置好。 ② 按下「Cancel/Off（取消／關）」按鈕，使錯誤訊息消失。 （若未按下「Cancel/Off（取消／關）」按鈕，錯誤訊息一會兒之後亦會消失。） ③ 再一次操作。
	● 是否有異物或污垢留在內鍋底部、蓋加熱板或內鍋感應器？ （第 18–19 頁） → 清除異物或污垢然後按下「Cancel/Off（取消／關）」按鈕。 ● 內鍋中是否有太多水？ → 按下「Cancel/Off（取消／關）」按鈕。 （下次烹調時，稍微減少水量。）
	● 保溫功能是否使用超過 96 小時？ → 按下「Cancel/Off（取消／關）」按鈕。
	● 外蓋打開了嗎？ ● 美味感應裝置固定了嗎？（第 18 頁） → 如美味感應裝置已遺失，請從經銷商購買。 美味感應裝置未固定也可煮飯或保溫，不過 <ul style="list-style-type: none"> 米飯味道可能很差。（如果進行保溫，米飯會變乾燥。） 或無法正常煲粥。 液體可能會溢出。 米飯烹調後「U15」可能會再顯示。 ● 美味感應裝置內是否有異物或污垢？ → 清除異物或污垢。（第 18 頁）
	● 微型電腦飯煲底部的吸氣孔及排氣孔是否有灰塵等物質阻塞？ → 使用以下步驟清除灰塵。 ① 按下「Cancel/Off（取消／關）」按鈕然後拔掉電源插頭。 ② 微型電腦飯煲冷卻後，請取出內鍋。 ③ 從微型電腦飯煲底部吸氣孔／排氣孔清除灰塵。（第 19 頁） ● 微型電腦飯煲是否有在地毯等物品上使用？（第 6 頁） → 請勿在微型電腦飯煲底部受到阻塞的地方下使用微型電腦飯煲。
	● 試著拔下電源插頭再重新插入。如果「H00」再次出現，即為故障訊息。 → 請詢問您的經銷商，並告訴他們該錯誤訊息（即在「H」後的兩位數字）。

如上述方法沒有任何改善，請向經銷商查詢維修事宜。

我的微型電腦飯煲有故障嗎？／這是什麼意思？

下一步應該怎樣...

- 微型電腦飯煲沒有故障。
檢查以下事項才要求維修。

米飯太軟（黏）

- 您是否正確量米和量水？（第8頁）
- 是否有大量斷開的米粒？
- 您是否將米長時間浸泡？（例如使用預約時。）
→ 使用預約時，嘗試稍微減少水量。
（減少水量至水位線下方大約1至2 mm處。）
- 您是否用熱水洗米？
- 您是否使用超過「1-2Person（少量）」程序少量的指定米量？
（1.0 L型號：0.5至1.5量杯，1.8 L型號：1至2.5量杯）
- 洗米時是否太用力？（可能造成米粒斷裂而濕黏。）
- 煮好飯後，您是否即時翻鬆？（可蒸發多餘水份。）
- 烹調新收割米時，您是否使用低於標準水量？（減少水量至水位線下方大約1至2 mm處。）
- 洗完米後您是否將米留在網漏內？
（第8頁 這可能會導致米粒斷裂，且煮熟後米飯可能會比較黏。）
- 如希望口感較硬：
 - 稍微減少水量。（減少水量至水位線下方大約1至2 mm處。）



米飯太硬（乾）

- 您是否正確量米和量水？（第8頁）
- 您是否使用「Quick（快速煮飯）」模式？
- 如希望口感較軟：
 - 稍微增加水量。
（增加水量至水位線上方大約1至2 mm處。）
 - 嘗試將米浸泡（30分鐘至2小時）才烹調。



米飯已煮焦

- 是否有正確處理及洗米？
 - 是否有污垢或異物堵塞內鍋感應器、內鍋底部或本體內部？
 - 您是否使用預約？（您是否將米長時間浸泡？）
 - 洗米時是否太用力？（可能造成米粒斷裂而煮焦。）
 - 是否有大量斷開的米粒？
 - 洗完米後您是否將米留在網漏內？
（第8頁 這可能會導致米粒斷裂，且煮熟後米飯可能會燒焦。）
 - 煮飯加調味料，例如煲仔飯可能很容易煮焦。
 - 內鍋底部產生金黃色米飯不代表故障。
- 如按照上述步驟沒有改善，請參考「如要改善飯焦」。（第25頁）



症狀

在此檢查！

冷凝產生。

- 煮好飯後，您是否即時翻鬆？（可蒸發多餘水份。）
- 您是否在保溫狀態期間米飯仍然在微型電腦飯煲內時關閉了保溫按鈕或拔掉了電源插頭？
- 霧層可根據烹調方式形成。

米飯有氣味。

- 您是否在保溫狀態期間米飯仍然在微型電腦飯煲內時關閉了保溫按鈕或拔掉了電源插頭？
 - 保溫功能是否操作12小時或更多？
 - 煮煲仔飯等加調味料完成後，氣味可能仍然存在。
 - 您是否有在保溫狀態時加入冷飯？
 - 是否有正確處理及洗米？
 - 使用保溫功能時您是否有將飯勺從微型電腦飯煲取出？
 - 是否每次使用後都進行清潔保養？
清潔保養不妥善的話，可能導致米飯味道變差或出現氣味。
如持續使用骯髒的微型電腦飯煲，可能導致米飯品質變差。
 - 烘烤蛋糕後有可能會殘留異味。
- 當明顯聞到米飯有氣味時，
- ① 小心清洗內鍋、蓋加熱板及美味感應裝置。（第18-19頁）
 - ② 如無法清除氣味，請使用清洗功能。（第19頁）

米飯是黃色。

- 保溫功能是否操作12小時或更多？
- 您是否有重複再加熱？
- 是否有正確處理及洗米？
- 某些米類，煮完飯後米飯可能帶有黃色。

米飯太乾。

- 保溫功能是否操作12小時或更多？
- 您是否有重複再加熱？
- 美味感應裝置是否正確裝好？
- 米飯黏在蓋加熱板的密封墊、外蓋的密封墊或內鍋邊緣？
- 內鍋是否有變形？
→ 如內鍋變形，請購買新的內鍋。

粥變糊。

- 您是否將米長時間浸泡？（例如使用預約時。）
- 烹調粥時您是否有使用保溫功能？

薄膜形成。

- 您是否過度洗米，導致米粒斷開？
- 是否有正確洗米？
（米內的澱粉溶解，然後在表面變成為薄膜。這是無害的。）

米飯黏在內鍋上。

- 軟米或糯米容易沾黏，這要視米的種類而定。

烹調好的米飯表面有凹形形狀。

- 烹調前米飯是否均勻散佈？
- 這可能因強力加熱，即是IH（感應加熱）的特性。這不是故障。

下一步應該怎樣...



- 如第 22-23 頁的建議沒有改善，您可以變更設定。
- 步驟 2-4 必須每個在 16 秒內完成。
如 16 秒內沒有任何操作，顯示屏幕則回復目前時間。
(無法設定。)
→ 請重新開始程序。
- 完成設定後，顯示屏幕回復目前時間。
- 若要返回先前設定，再次按照程序進行。

如果想要改變保溫溫度。 (74→76→72)

- 1** 按下 **Menu Select 功能選擇**，並設定「◀」
為「Quick (快速煮飯)」。



- 在「Pearl Rice (珍珠米)」或「Jasmine Rice (茉莉米)」下選擇「Quick (快速煮飯)」

- 2** 按下 **Keep Warm**。您將不會聽到嗶一聲。

- 按下 **Timer 1-2 預約1·2**。您將不會聽到嗶一聲。

- 按下 **Keep Warm**。
-

- 3** 按下 **Start 開始**。
-

- 預設值為「74」。

- 4** 當米飯發出米香味

- 按下 **Menu Select 功能選擇**。

設定至「76」。



10 秒後
(設定自動結束。)



當米飯顏色發生變化或是米飯過乾

- 按下 **Menu Select 功能選擇**。

設定至「72」。



10 秒後
(設定自動結束。)



如要改善飯焦。

- 1** 按下 **Menu Select 功能選擇**，並設定「◀」
為「Quick (快速煮飯)」。



- 在「Pearl Rice (珍珠米)」或「Jasmine Rice (茉莉米)」下選擇「Quick (快速煮飯)」

- 2** 按下 **Keep Warm**。您將不會聽到嗶一聲。

- 按下 **Timer 1-2 預約1·2**。您將不會聽到嗶一聲。

- 按下 **Keep Warm**。
-

- 3** 按下 **Menu Select 功能選擇**。
選擇「02」。
-

- 按下 **Start 開始**。
-

- 4** 按下 **Menu Select 功能選擇**。
設定至「So:Lo」。
-

10 秒後
(設定自動結束。)



若要在烹調、再加熱及清洗時 停止鈴聲提示 (結束聲音)。

- 1** 按下 **Menu Select 功能選擇**，並設定「◀」
為「Quick (快速煮飯)」。



- 在「Pearl Rice (珍珠米)」或「Jasmine Rice (茉莉米)」下選擇「Quick (快速煮飯)」

- 2** 長按 **Keep Warm**。
(大約 5 秒)



- 這個變更不會關掉按鈕聲音。

規格

程序		大約烹調時間	保溫功能*	預約設定限制	烹調容量 (量杯) ()用於添加其他食材時。	
					SR-FC108	SR-FC188
Pearl Rice (珍珠米)	Delicious (美味模式)	50 分鐘	○	完成前 60 分鐘	0.5–5.5	1–10
	Regular (標準)	37 分鐘	○	完成前 50 分鐘	0.5–5.5	1–10
	Quick (快速煮飯)	19 分鐘–33 分鐘	○	—	0.5–5.5	1–10
	1-2Person (少量)	50 分鐘	○	完成前 60 分鐘	0.5–1.5	1–2.5
Jasmine Rice (茉莉米)	Congee (粥)	設定時間 1 小時–4 小時	×	完成前烹調時間 +1 分鐘或更長	0.5–0.75	0.5–1.5
	Casserole (煲仔飯)	50 分鐘	×	—	1–3	2–6
	Brown Rice (糙米飯)	1 小時 35 分鐘– 1 小時 55 分鐘	×	完成前 130 分鐘	1–3 (1–2)	1–7 (1–5)
	Grains (什穀米)	45 分鐘–55 分鐘	×	完成前 60 分鐘	0.5–4	1–8
Cake (蛋糕)		設定時間 40 分鐘–60 分鐘	×	—	麵糰上限 600 g	麵糰上限 900 g
Steam (蒸)		設定時間 1 分鐘–60 分鐘	×	—	水量 500 mL	水量 600 mL

*「×」符號代表微型電腦飯煲將自動轉換成保溫功能，但不建議使用。(第 13 頁)

		SR-FC108	SR-FC188
電源		220 V ~ 50 Hz	
耗電量 (大約)	烹調時	1100 W	1300 W
	保溫時	710 W (27.6 Wh*1)	650 W (32.8 Wh*1)
內鍋的額定容量		3.0 L	5.0 L
電源線長度 (大約)		1.0 m	
重量 (大約)		4.6 kg	5.7 kg
外形尺寸 (寬×深×高) (大約)		25.5 cm × 36.6 cm × 21.0 cm (40.2 cm*2)	28.4 cm × 39.2 cm × 24.3 cm (45.6 cm*2)

*1 保溫狀態每小時的耗電量。(房間溫度 20 °C, 最大米量。)

*2 外蓋打開時的高度。

- 耗電量是指電力容量的上限。
- 當開關是「關」，微型電腦飯煲耗損大約 1.6 W (電源插入狀態)。
- 這個微型電腦飯煲是就香港而設定。
微型電腦飯煲是不適合在不同電源頻率或電壓的國家或地區使用。而且不設更換服務。

檢查		檢查您的 IH 微型電腦飯煲！	
	您是否察覺到以下情況？		停止使用微型電腦飯煲
	<ul style="list-style-type: none"> ● 電源插頭及電源線異常發熱。 ● 電源線損毀或碰到電源線後發生間歇性斷電。 ● 本體變形或異常發熱。 ● 本體冒煙或發出焦味。 ● 本體破裂、鬆動或發出異常聲響。 ● 烹調時底部風扇不旋轉。 		若要避免意外，請立即停止使用微型電腦飯煲，拔掉電源插頭，向您的經銷商進行檢查。

Panasonic Corporation

網站：<http://www.panasonic.com.hk>

© Panasonic Corporation 2018