

Panasonic®

Operating / Installation Instructions

Induction Heating Cooktop

For domestic use

Model No. **KY-E227E**

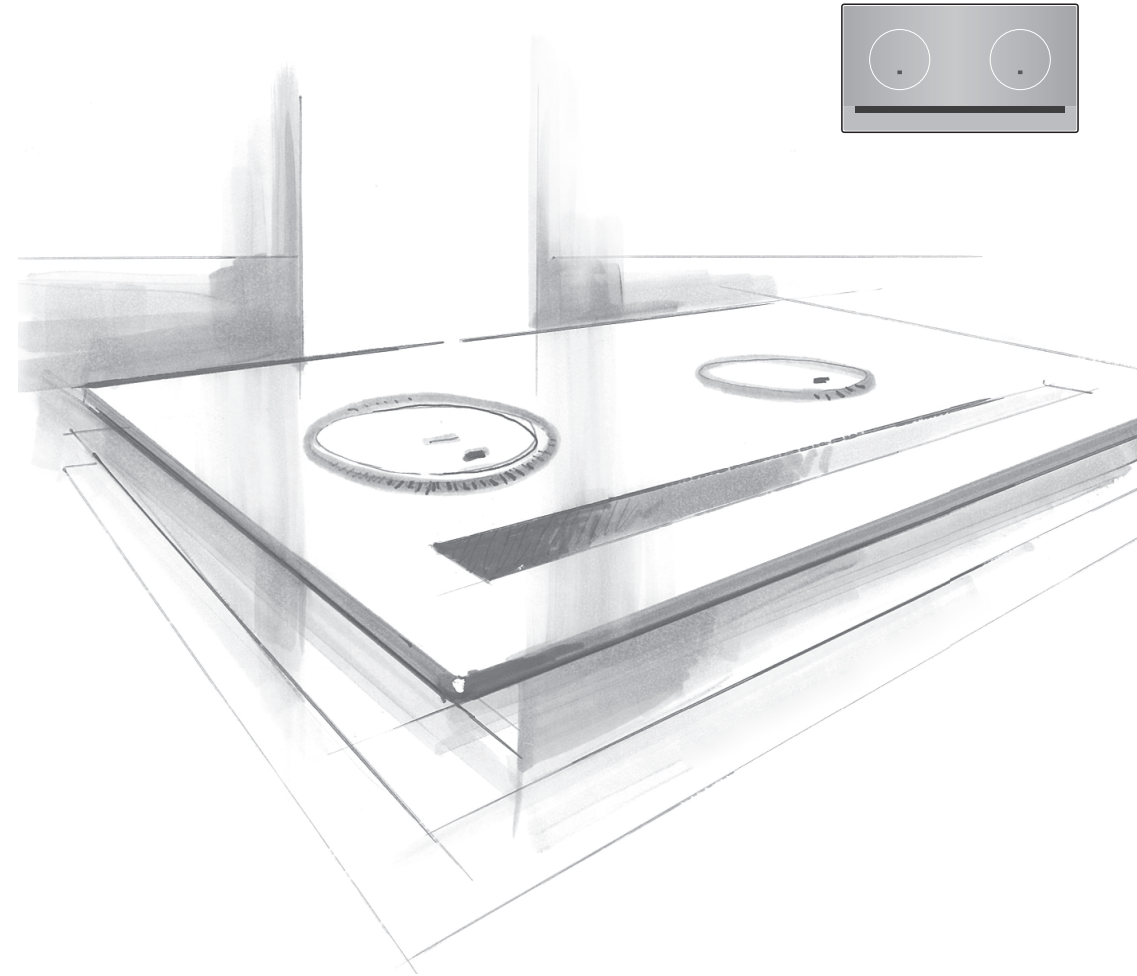
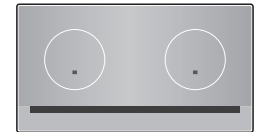

Panasonic Corporation
Web Site: <http://panasonic.com>

© Panasonic Corporation 2019

Printed in Japan

Thank you for purchasing this Panasonic appliance.
This appliance is intended for household use only.
This appliance can be selected as free-standing or built-in.
Please read these instructions carefully before using the appliance.
Keep Operating/Installation Instructions and Guarantee Certificate
for future use.

ENGLISH

 ZY02HG371
H0719M1119

IR sensor eases your cooking

Contents

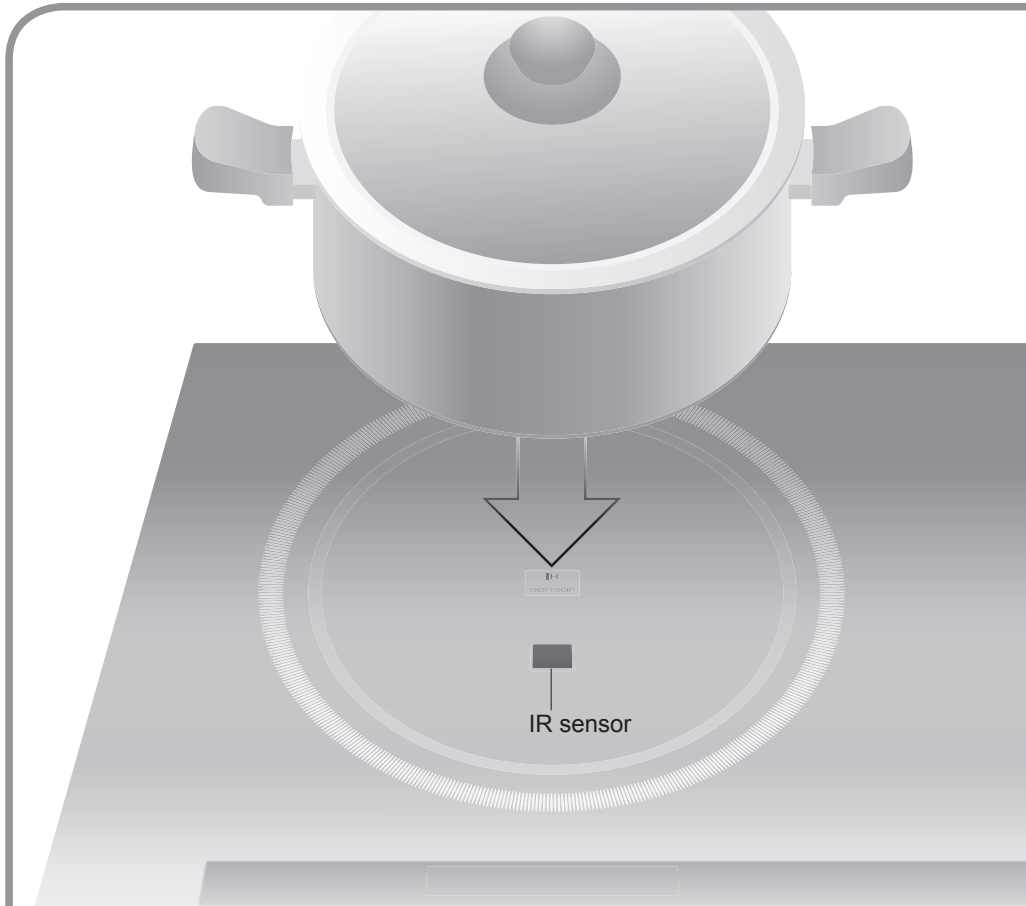

Place the cookware in the centre of the cooking zone.

The IR sensor must be covered to operate properly.

What is the IR sensor?

IR sensor prevents overheating and restores the temperature to the original level when the temperature drops by adding ingredients.



Pan-frying Mode

Cooks delicious food without burning due to overheating



Deep-frying Mode

Automatically maintained temperature makes food crispy and tasty.

IH (Induction Heating) features

Safe

Flameless, comfortable cooking with less rise in room temperature



Clean

Flat top plate for easy care



Efficient

Highly efficient and energy-saving heating



IH Cooking Mechanism

The magnetic line of force produced in the magnetic coil, passes through the metallic cookware, induces an eddy current, and then the cookware generates heat with its electrical resistance.

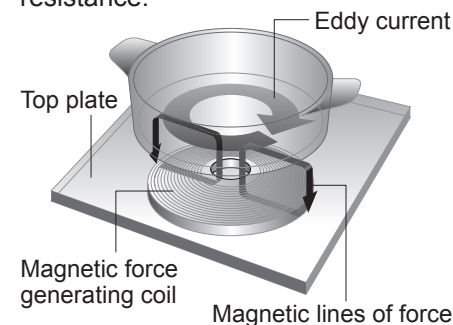

Safety Precautions	4	Preparation
General Precautions	7	
- Safety features	7	
Part Names / Functions	8	
Suitable Cookware	10	

Basics	12	Usage
Heating Mode	13	
Pan-frying Mode	14	
Deep-frying Mode	15	
Congee Mode	16	
Count-up Timer / Timer	18	

Cleaning	19	Care
Error Indications	20	
Troubleshooting	22	
Specifications	31	

Installation (For installer)	25	Installation
------------------------------	----	--------------

Safety Precautions

WARNING

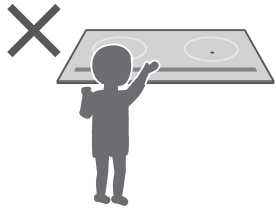

This appliance is not intended for use by persons (including children) with reduced physical, sensory or mental capabilities, or lack of experience and knowledge, unless they have been given supervision or instruction concerning use of the appliance by a person responsible for their safety. Children should be supervised to ensure that they do not play with the appliance. Keep infants away from the appliance.

To avoid fires from overheated oil



- **WARNING:** Unattended cooking on a hob with fat or oil can be dangerous and may result in a fire.
- Set to **6** or below for preheating.
- Do not overheat oil.

For proper function of the IR sensor

- Cover the sensor.
- Wipe water off.

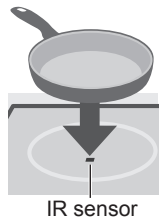

IR sensor



For deep-frying:

- Use  .
- Observe the amount of oil.

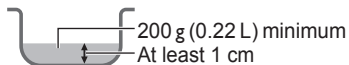

To avoid injuries or burns caused by bumping



Liquids may splatter.

- Stir liquids before heating.



To avoid fire, explosion or electric shock



- Do not apply excessive pressure. It may crack the top plate.



- **WARNING:** If the top plate is cracked, do not touch. Turn off the main power switch to avoid the possibility of electric shock.



- **Danger of fire:** Do not store items on the cooking surfaces.

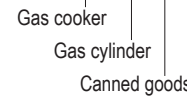

- Do not place combustible materials near the appliance.
- After use, turn off the appliance by its control and do not rely on the pot detector (safety features).
- Turn off the circuit breaker when not using the appliance for long period of time.
- Do not disassemble, repair or modify the appliance by yourself.

To avoid injuries or burns



 **CAUTION:** Hot surfaces

- Do not touch the top plate.



- Metallic objects such as knives, forks, spoons, lids and aluminum foil should not be placed on the hob surface since they can get hot.

In case of a malfunction or breakdown

- Smell of burning
- Feeling electricity through the top plate
- Cracked top plate
- Extremely hot power cord
- The power shuts off when the cord is moved.

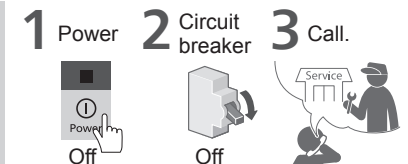







If the power cord is damaged, it must be replaced by the manufacturer, its service agent or a qualified person in order to avoid a hazard.



Safety Precautions

CAUTION

To avoid fire or accidents

- 
 - If you are wearing a medical device, such as a pacemaker, consult your doctor. The operation of the appliance may affect the medical device.
- 
 - **CAUTION:** The cooking process has to be supervised. A short term cooking process has to be supervised continuously.
- 
 - Do not use the appliance for purposes other than cooking.
- 
 - Do not place paper or dish towels under the cookware.
- 
 - For deep-frying:
 - If the oil smokes, .
- Do not use oil preheated by other appliances. The oil temperature control system will not work properly.

To avoid injuries or burns

- 
 - Ensure the cookware is stable.
- 
 - For deep-frying:
 - Do not bring your face close to the cookware.

Splattering hot oil

To avoid damage to the cookware

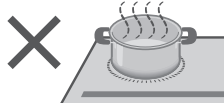
- 
 - Do not heat empty cookware.
 - Do not overheat ingredients.

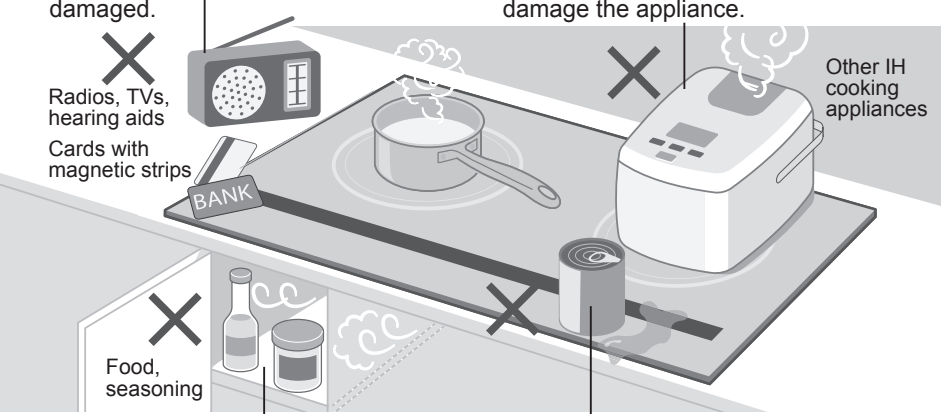

General Precautions

- Do not place the following near or on the top plate.
 - Noise interfered, data erased or damaged.
 - ✗ Radios, TVs, hearing aids
 - ✗ Cards with magnetic strips
 - Generated electromagnetic waves damage the appliance.
 - ✗ Other IH cooking appliances
- 
 - They may be spoiled by the exhaust heat.
 - ✗ Food, seasoning
 - The operation panel key may malfunction.
 - ✗ [Other IH cooking appliances]
- The appliance is not intended to be operated by an external timer or separate remote control system.
- Do not block or clog.
 - The filter clog detection may be activated, and the appliance may shut off automatically.

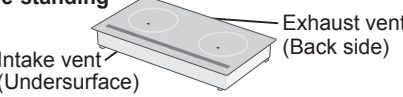
Free-standing



Safety features

Heating stops.	<ul style="list-style-type: none"> ● No cookware is detected (P.21) ● Small object on the cooking zone (P.21) ● Empty pot on the cooking zone (P.20) ● No operation for a long time (P.22)
Heating power is reduced.	<ul style="list-style-type: none"> ● Overheating prevention (P.23) Heating power is reduced automatically when the bottom of the cookware overheats.
The main power turns off.	<ul style="list-style-type: none"> ● Main power auto shut-off The main power automatically turns off if 1 minute has elapsed without any operation.
Illuminates when the top plate is hot.	<ul style="list-style-type: none"> ● Hot surface warning (P.9) 
Locks all operations.	<ul style="list-style-type: none"> ● Child lock (P.9) 

Part Names / Functions

Luminous circle

- Illuminates while heating, and changes the brightness according to the heat level.
- Even if heating is stopped or the main power is turned off, it keeps flashing as long as the top plate is hot.

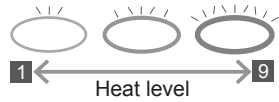

*For explanation purposes, the display and light status of the illustration below is different from those at the time of use.

Operation panel



Pan-frying mode (P.14)



Pan-frying with temperature setting

- Count-up timer: ✓
- Timer: ✓

Deep-frying mode (P.15)



Deep-frying with temperature setting

- Count-up timer: ✓
- Timer: N/A

Heating mode (P.13)



For basic cooking

- Count-up timer: ✓
- Timer: ✓

ECONAVI



The IR sensor regulates the set temperature by quickly detecting the temperature change of the oil or the bottom of the cookware.

- It works even if the size or material of the cookware, or the amount of food, changes.
- Example of energy-saving effect (P.31)

Left IH heater

Right IH heater

Top plate

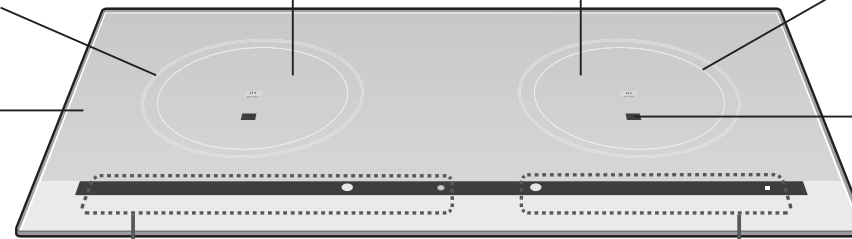

Cooking zone (Ø 190 mm)



- Use the area inside of the circle.

IR sensor
(one for each heater)

Main power light

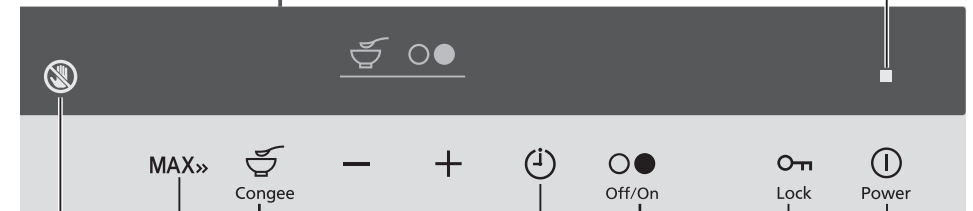

Congee mode (P.16)



Automatic congee cooking

- Count-up timer: N/A
- Timer: Automatic

Heating mode (P.13)

MAX key









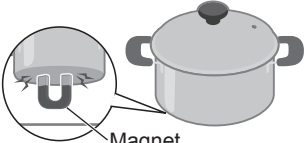

- Touch to set the heat level of the right cooking zone to 9. The level may be 8 or below when the left cooking zone is in use.

Hot surface warning (one for each heater)

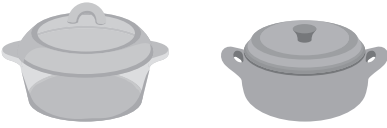
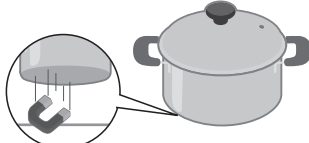
- Illuminates when the top plate is hot.
- Even if heating is stopped or the main power is turned off, it keeps flashing as long as the top plate is hot.

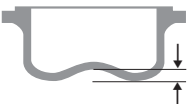

Suitable Cookware

	✓ Compatible	✗ Incompatible	
Material	<ul style="list-style-type: none"> ● Iron / Cast iron  ● Enamelled iron  ● Magnetic stainless steel  	<ul style="list-style-type: none"> ● Aluminum / Copper  ● Heat-resistant glass / Ceramic and earthenware  ● Nonmagnetic stainless steel  <p>Not heatable or heating power may be reduced</p>	
	Bottom shape	<ul style="list-style-type: none"> Flat  	<ul style="list-style-type: none"> Round  Legged  Curved  <p>*The safety feature may not function properly, heating power may be reduced, or the cookware may not be heated.</p>
		Size	<ul style="list-style-type: none"> 12 cm or over 

How to check compatibility



Note

- Ceramic and earthenware
 - Even if they are made for induction heating:
 - The appliance may malfunction.
 - Heating power is reduced.
 - Heating stops.

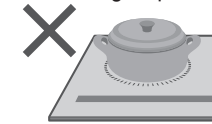

- Thin bottom
 - Turns red-hot and/or deforms

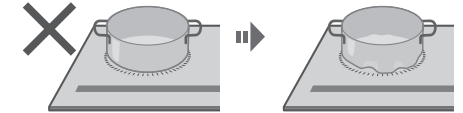

- Empty enamelware
 - Enamel coating may melt and damage the top plate.

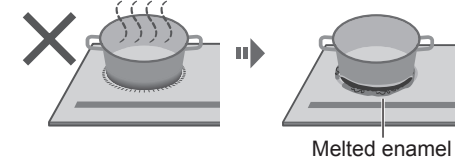

- Using  or 

- Depending on the type, material, and the bottom shape and size of the cookware:
- The actual oil temperature may vary from the set temperature.
 - Preheating may take longer.
 - Heating may stop.

- Using  has other restrictions. (P.16)

Basics

How to turn on the power

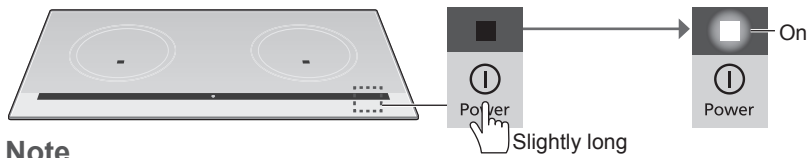

Note

- The power automatically turns off if 1 minute has elapsed without any operations.

Cooking tips

- Cover the sensor.

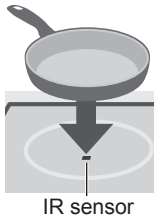

- Wipe water off before cooking.



- When heating more than 45 minutes

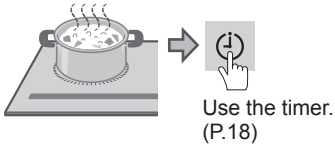

Use the timer.
(P.18)

- When using  Deep-Fry

For proper function of the temperature control:

- Observe the amount of oil.

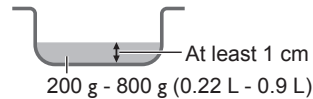

- Do not use these oil.

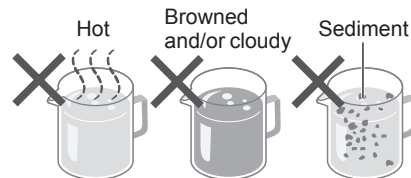

- After preheating starts

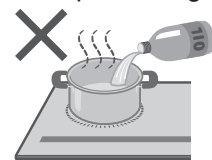

- When preheating

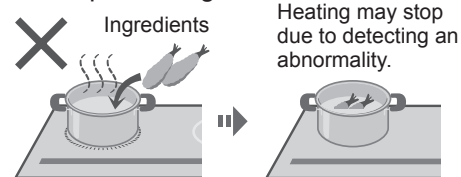

Heating Mode



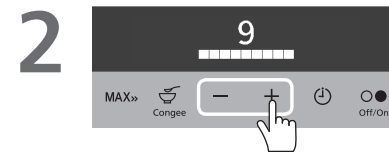
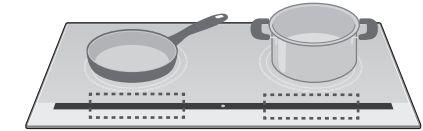
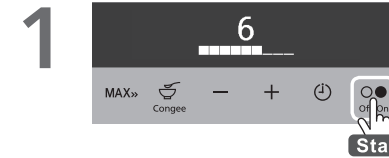

For basic cooking

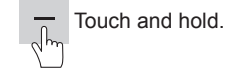

- Heat level range: **1 - 9**

- To lower the level rapidly:



- To raise the level to max (P.9): 

- **Count-up timer / Timer**  (P.18)

- 3 When the cooking is completed:

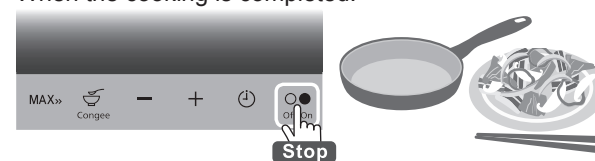

Heat level adjustment guideline

Low			Medium			High		
1	2	3	4	5	6	7	8	9
75 W	235 W	370 W	500 W	700 W	1000 W	1450 W	2000 W	3200 W
Keep warm			Simmer			Boil, steam or stir-fry		
Reheat			Simmer lightly			Pasta, vegetables		
Ingredients			Thick soup			Steamed meat bun		
Pan-fry slowly*			Light soup			Vegetables		
Hamburger steak			Pan-fry quickly*			Hot water		
Pan-fry quickly*			Steak			Pan-fry quickly*		

• Heat values may vary depending on material of the cookware.

*Recommend to use Pan-frying mode. (P.14)

Pan-frying Mode



Pan-frying with the temperature setting

1

2

• Temperature range: 140°C - 230°C

Preheating is completed.

■ Count-up timer / Timer (P.18)

3 When the cooking is completed:

Temperature adjustment guideline

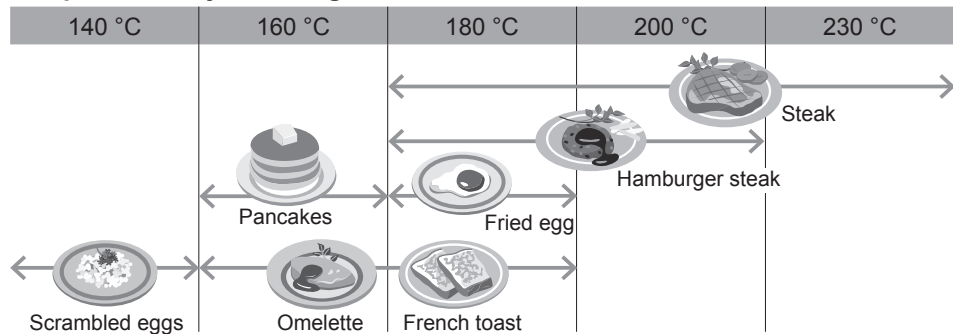

Deep-frying Mode



Deep-frying with the temperature setting

1

2

• Temperature range: 140°C - 200°C

Preheating is completed.

■ Count-up timer (P.18)

3 When the cooking is completed:

Temperature adjustment guideline

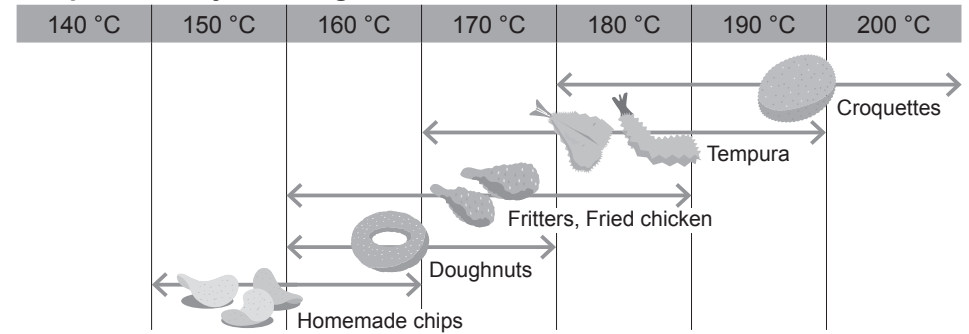

Congee Mode



Cooking congee automatically

(For 4 or 2 servings)

- Measure rice and water correctly.

	Rice	Water
4 servings	170 g (approx. 200 mL)	2.4 L
2 servings	85 g (approx. 100 mL)	1.3 L

- Do not use hot water.

- Suitable pots

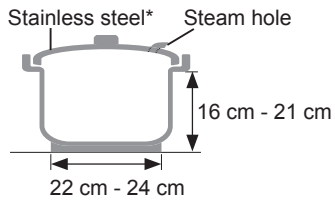

*With non-stick coating pots, congee may not be as thick.

- After washing rice

Drain the water.



- When cooking

Close the lid.



- When the top plate is hot



After cooled down.

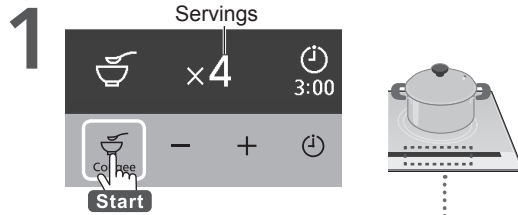

- The number of servings and the cooking time can be changed within 15 seconds after cooking starts.

■ For 2 servings



■ To cook less thickened congee (Reduce cooking time)

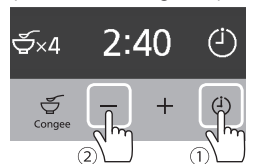

- Setting range: **2:00 - 3:00** (By 10 min.)
- Touch and hold to change rapidly.

■ To cancel cooking

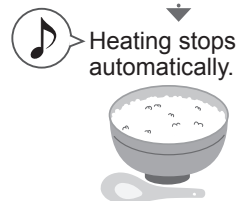
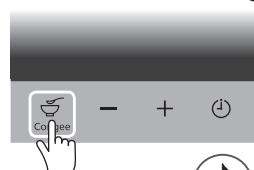

Congee with chicken and dried scallops



Ingredients	4 servings	2 servings
Dried scallops	20 g	10 g
Fresh chicken	200 g	100 g
Rice	170 g	85 g
Water (including soaking water)	2.2 L	1.2 L
Ginger (chopped)	1 slice (15 g)	1/2 slice (7.5 g)
Salt	tsp. 1	tsp. 1/2

* Topping: Century egg, coriander, welsh onion, etc.

Cooking steps

1 Preparation

- ① Soak in the water until tender.
 - ② Chop finely.
- Dried scallops
- The water will be needed in step 2.
- ① Remove skin and fat.
 - ② Wash and dry.
 - ③ Rub in.
- Chicken
- Rice
- Wash rice and drain the water.

2 Put the ingredients into the pot.

- ① Scallops, Ginger, Rice
 - ② Chicken
- Water and the soaking water used in step 1
- Make the surface flat.
- For 2 servings Cut the chicken into size to be soaked.

3 Start cooking.

- ① Close lid and start.
 - ② Stir occasionally to prevent scorching.
- Heating stops automatically
- For 2 servings
- ① Stir.
 - ② Flake the chicken.
- As you like
- Note**
- Do not shorten the heating time. The chicken may be cooked raw.

Note

- When boiling over Let out the steam.
- When the room temperature is low Congee may not be as thick. ⇨ Simmer it again.



Count-up Timer / Timer

Count-up timer can be set with and Timer can be set with .

Setting Count-up timer

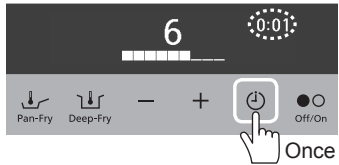

• To cancel Count-up timer, touch twice.

Setting Timer

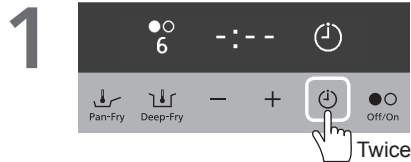

• If no key operation for 5 seconds, Timer will be canceled.

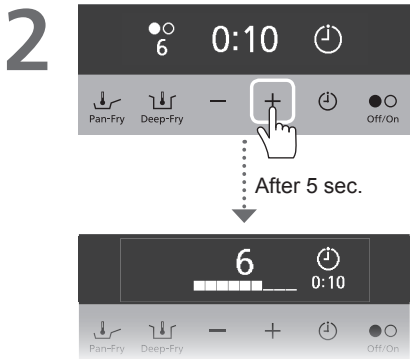

• Setting range: **0:01 - 9:30**
 • Touch and hold to change rapidly.
 • Time setting:

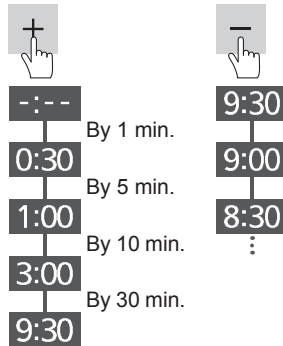

• To cancel Timer



Heating stops automatically.

Note

- Count-up timer does not turn off the cooking zone.
- For , timer starts running after preheating is completed.

Cleaning

Always keep the appliance clean.

Spilled food or oil scorched on the appliance may become difficult to clean.

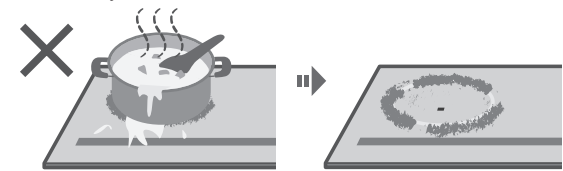

CAUTION

• Before cleaning

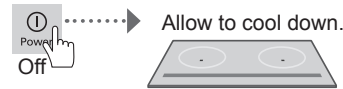

• Do not use a steam cleaner.

Water may get into the electrical components and cause a malfunction.



Light stains

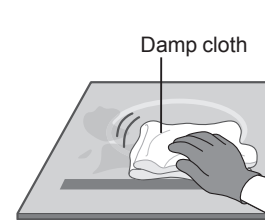

Oil stains

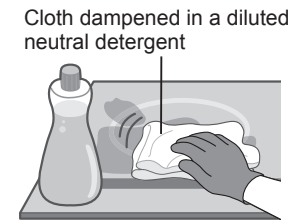

Heavy stains



Note

• Be sure to remove stains.

• Stain will be scorched and stuck on the top plate.



• Free-standing appliance

Wipe off oil stains from the front and side of the appliance.





Error Indications



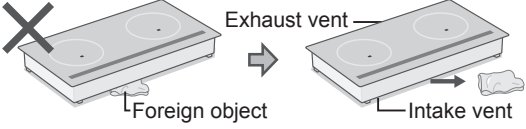
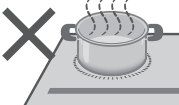

If any of the following error indication appears, check the cause and resolve.

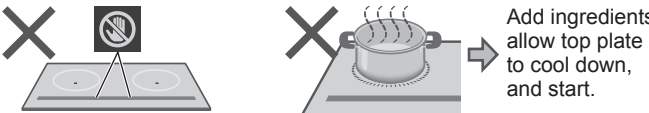
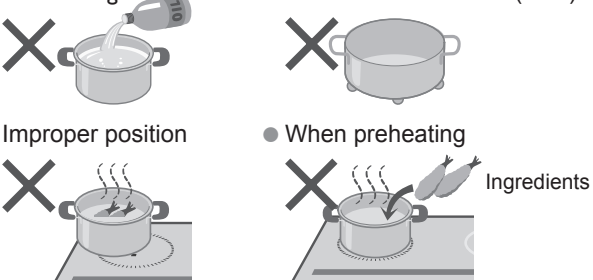
After eliminating the cause, touch  or  to clear the error indication.

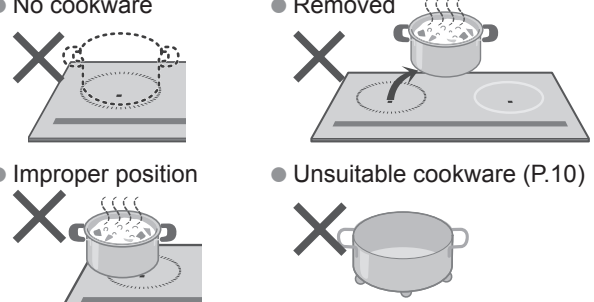

• Also  can clear the **U19** indication, and  can clear the **U33** or **U34** indication.

Indication	Possible cause
U04	<ul style="list-style-type: none"> Clogged intake and/or exhaust vent 
U13 U14	<p>Empty pot on the cooking zone</p> <ul style="list-style-type: none"> Empty pot is heated.  <p>*This function may not operate properly, depending on the type of pot, or if the heat level is low.</p> <hr/> <ul style="list-style-type: none"> When deep-frying, oil was overheated by Heating mode.  <p>Be sure to use the Deep-frying mode.</p>
U19	<p>When using Congee mode</p> <ul style="list-style-type: none"> The top plate is hot. Empty pot  <p>Add ingredients, allow top plate to cool down, and start.</p>
U33 U34	<p>When using Deep-frying mode</p> <ul style="list-style-type: none"> Over 800 g Unsuitable cookware (P.10) Improper position When preheating 

Heating automatically resumes if the cause of the following error is eliminated.







Indication	Possible cause
U16	<ul style="list-style-type: none"> Stains on the operation panel  <p>Water, ingredients or foreign objects</p> <p>①  ② Set the appliance again as required.</p> <hr/> <ul style="list-style-type: none"> Improper operation  <p>Operation keys More than 3 sec.</p>
6	<p>No cookware is detected*</p> <ul style="list-style-type: none"> No cookware Removed Improper position Unsuitable cookware (P.10)  <hr/> <p>Small object on the cooking zone*</p> <ul style="list-style-type: none"> Metallic objects  <p>*The power shuts off in 1 minute under the conditions above.</p>



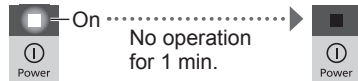
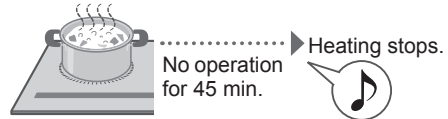
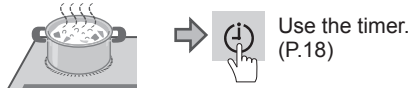
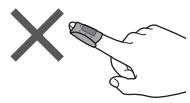
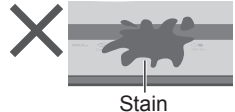

When the problem cannot be resolved, or any **H00** error appears

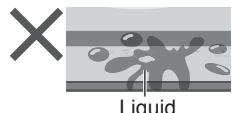
- 1 Power  Off
- 2 Circuit breaker  Off
- 3 Call. 

*For the contact list for the service centre, refer to the Guarantee Certificate.

Troubleshooting



Symptom	Possible cause
■ Power Source	
The main power cannot be turned on.	The power cannot be easily turned on to prevent unintended operation.  Slightly long
	Locked (P.9)  3 sec. Unlock
The main power turns off.	Main power auto shut-off  No operation for 1 min.
Heating stops while cooking.	No operation for a long time  No operation for 45 min. Heating stops.
	● To simmer for a long time:  Use the timer. (P.18)
■ Operation Panel	
Key operation is disabled.	● Fingertip is covered.  ● Key operation may be disabled when you are operating the appliance while holding the cookware handle.
	 Stain  ① Power Off ②
Keys react when the surrounded area is touched.	 Liquid  ① Power Off ②

Symptom	Possible cause
■ Sound and Noise	
Noise is heard while heating.	Depending on the type of cookware: <ul style="list-style-type: none"> • Making various sounds • Feeling vibrations when holding the handle • Moving slightly  It is not a malfunction. Slightly move or replace the cookware.
	If the cookware is removed while heating, a short metallic sound may be heard. 
After the main power is turned off, sound from the fan can still be heard.	The cooling fan operates while the inside of the appliance is hot. When the appliance cools down, it will automatically stop.
■ Heating Power	
Heating power is weaker.	Overheating prevention Heating power will be reduced automatically without changing the heat level indication. Heating power returns to normal after the cookware cools down. 
	Ceramic and earthenware (P.10)  *Do not use ceramic and earthenware, even if they are made for induction heating.
When using the both cooking zones together: <ul style="list-style-type: none"> • Heating power or the indication level decreased. • The heat level cannot be increased. 	Heating power is automatically regulated to restrict overall power consumption. (P.31)  To increase the heat level, avoid using the both cooking zones together, or reduce the heat level of either of cooking zone.



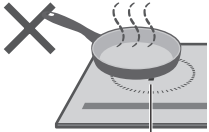
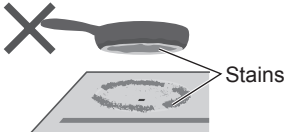
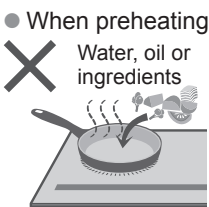
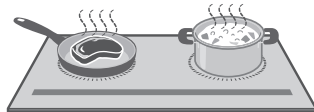

Troubleshooting

Symptom	Possible cause
---------	----------------

■ Pan-frying Mode

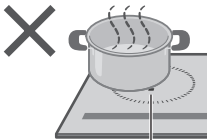
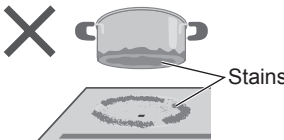
<ul style="list-style-type: none"> • Preheating takes too long. • The actual temperature is different from the set temperature. 	 <p>IR sensor is not covered. (P.4)</p>	 <p>Stains</p>
	<ul style="list-style-type: none"> • When preheating  <p>Water, oil or ingredients</p>	<ul style="list-style-type: none"> • If the right cooking zone is used at the same time, preheating may take longer. 
	<p>The temperature on the bottom of the pan may vary from the set temperature depending on the type of the pan.</p>  <p>Adjust the temperature as required.</p>	

■ Deep-frying Mode

<ul style="list-style-type: none"> • Preheating takes too long. • The actual temperature is different from the set temperature. 	 <p>IR sensor is not covered. (P.4)</p>	 <p>Stains</p>
	<ul style="list-style-type: none"> • Over 800 g 	<ul style="list-style-type: none"> • Unsuitable oil  <p>Hot Browned and/or cloudy Sediment</p>
	<p>The oil temperature may vary from the set temperature or preheating may take longer depending on the type, material, and shape and size of the bottom of the pot.</p>  <p>Adjust the temperature as required.</p>	

Installation

(For installer)

Contents

Safety Precautions	26
Dimensions	27
Installation Location	28
Electrical Work	28
Installing the Appliance	29
Post-installation Checklist	30

! Important

- Install the appliance in accordance with the Installation Instructions. Otherwise, the performance of the appliance may be affected.
- The installer is responsible for proper installation. Any malfunction or accident resulting from the failure to follow the instructions is not covered by the warranty.
- Make sure to have a qualified gas technician or personnel from gas company close the gas valve when replacing the gas appliances with this unit.
- Do not install an oven under the cabinet.
- After installation, perform an electrical test.
- Explain to the customer how to use the appliance correctly.
- Provide the Operating / Installation Instructions to the customer for the local electrical inspector's use.

Safety Precautions

⚠ WARNING

To avoid fire, electric leakage, electric shock or abnormal operation

- If the power cord is damaged, it must be replaced by the manufacturer, its service agent or a qualified person in order to avoid hazards.
- Electrical work must be performed by a legally certified electrician.
- Before installation, make sure to turn off the circuit breaker.
- Install a 220 V / 20 A dedicated single-phase circuit with an earth leakage circuit breaker for the power supply to avoid abnormal overheating of the electric wire.
- This appliance must be properly earthed following the electric laws.
- The earth line must not be connected to a gas pipe, water pipe, earth of lightning rod or telephone.
- The power cord must be correctly connected to ensure the integrity of the connection.
- Do not step on the appliance, or drop heavy items on top of it.
- Do not disassemble, repair or modify the appliance. (Ex. Disassembling the top plate)

⚠ CAUTION

To avoid fire, deformation or discolouration

- Use a heat resistant material for the countertop. (Heat resistance equal to or exceeding that of "laminated thermosetting high-pressure decorative sheets")
- Do not use a varnished material for the countertop.

Dimensions

■ Top view

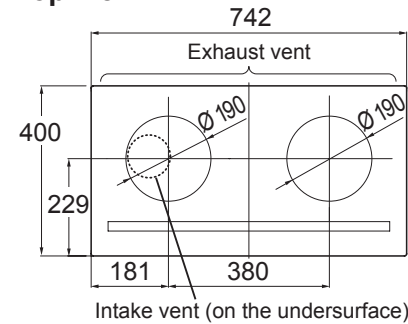

■ Front view

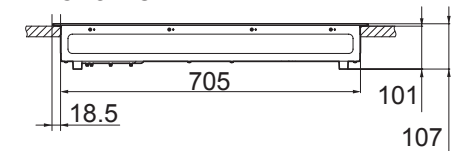

■ Side view

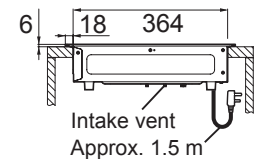

Related Dimensions (Built-in)

■ Countertop cutout

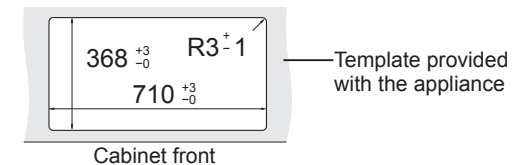

■ Cabinet

Countertop with bulge in front

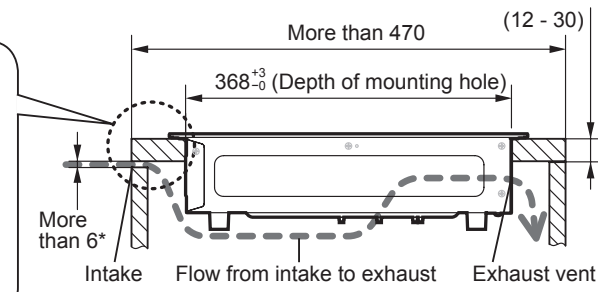
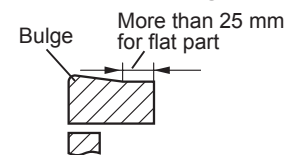

■ If a partition board without an intake part has been set

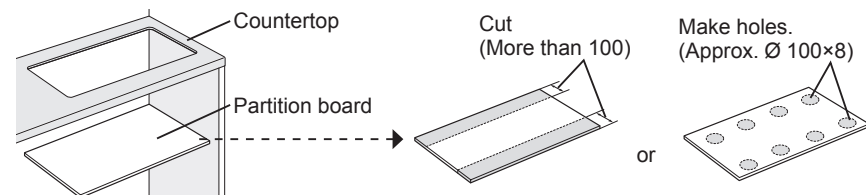

Installation Location

- Observe related laws for installation.

Wall and ceiling	Built-in			Free-standing		
	Minimum clearance (unit: cm)			Minimum clearance (unit: cm)		
	(A)	(B)	(C)	(A)	(B)	(C)
Incombustible*1	0	70	0	1*2	70	0
Combustible	5	100	5	5	100	5

*1 Metal, tile, brick, etc. (Including heat-insulating board made of metal, tile, brick, etc.)

*2 An exhaust vent is provided on the back of the appliance.

Electrical Work

- Follow the local safety laws and regulations for electrical wiring and earthing applied in the area.
- Do not twist or load on the power cord.

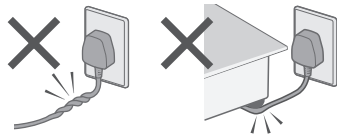

WARNING

- Provide socket wiring for single-pole earthing.

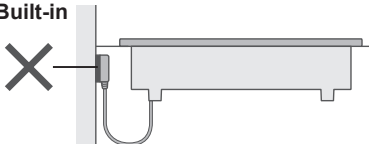
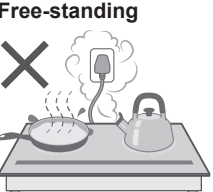
Dedicated circuit	<ul style="list-style-type: none"> • Single-phase 220 V/20 A (with a circuit breaker) • Electric wire for house wiring: Single wire of at least 2.0 mm in diameter *Stranded wire of at least 3.5 mm² can also be used for the wall socket (box type).
Earth leakage circuit breaker	<ul style="list-style-type: none"> • Rated current: 30 A • Rated sensitivity current: 30 mA *In accordance with the electrical wiring rules, incorporate the breaker and the earth leakage circuit breaker in the home electrical wire.
Wall socket	<ul style="list-style-type: none"> • Type of socket:  BS546 type (15 A) • Installation location <div style="display: flex; justify-content: space-around;"> <div style="text-align: center;"> <p>Built-in</p>  <p>Install the socket where the plug can be disconnected.</p> </div> <div style="text-align: center;"> <p>Free-standing</p>  </div> </div>



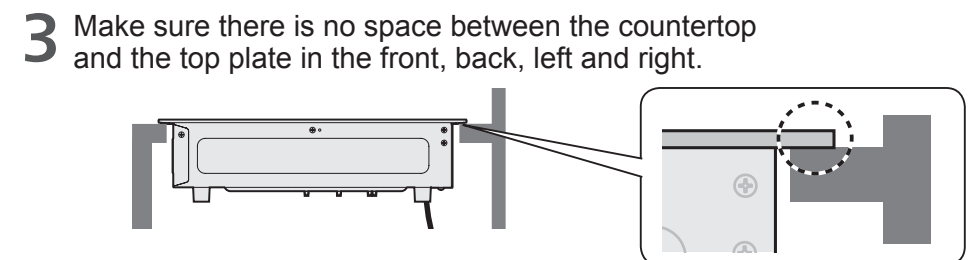
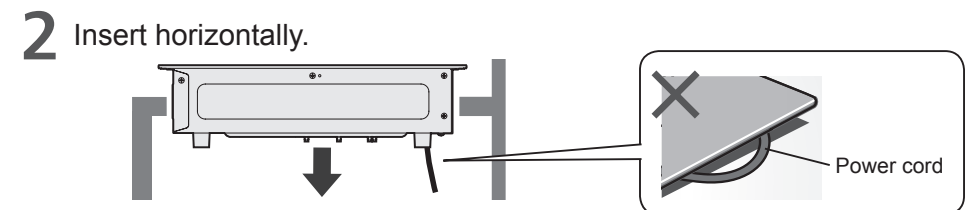
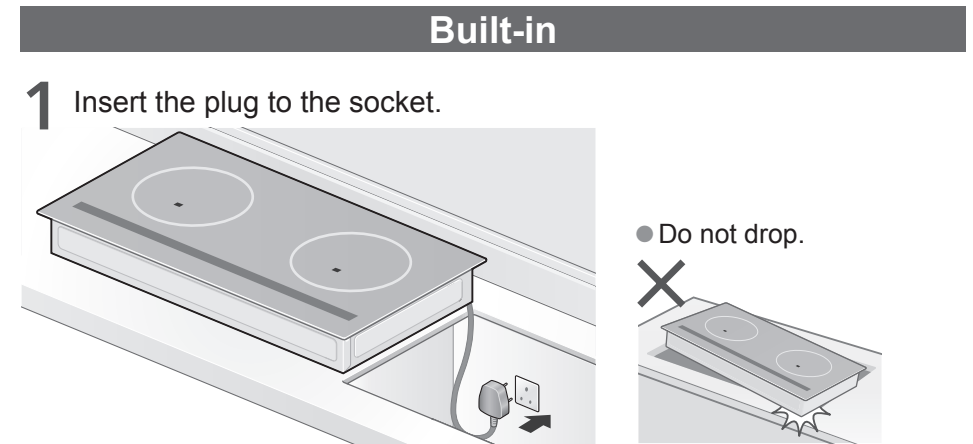
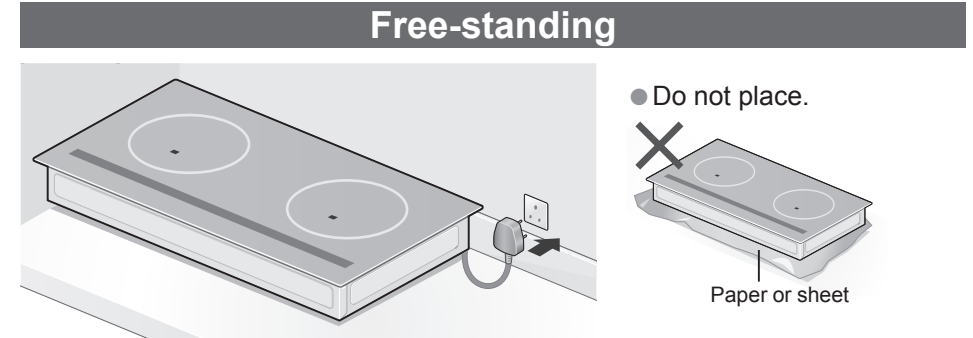

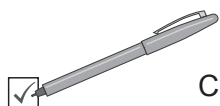

Installing the Appliance

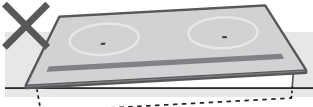
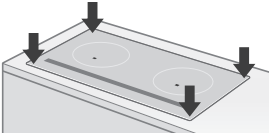

Post-installation Checklist

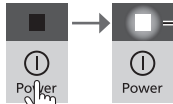

Check and mark off the following items.

Installation	<ul style="list-style-type: none"> ● Not tilted  ● Securely inserted • Press lightly and make sure the corner of the top plate is not lifted up.  ● Clean  	<input type="checkbox"/>
Electrical work	<ul style="list-style-type: none"> ● The power supply is a single phase, 220 V. ● The earth has been installed. ● The earth leakage circuit breaker has been installed. 	<input type="checkbox"/>
Electrical test	<p>1  →  Check if the light is on.</p> <p>2    Check if the indication is flashing.</p>	<input type="checkbox"/>

- Turn off each cooking zone and the main power after performing the electrical test.
- Provide the Operating / Installing Instructions and Guarantee Certificate to the customer.

I hereby certify that installation has been completed.

Signature of installer

Specifications

Power supply	Single phase 220 V ~ 50 Hz
Power consumption	3200 W
Standby power consumption (approx.)	0.9 W *When the main power is off
Dimensions (approx.)	(W) 742 × (D) 400 × (H) 107 mm
Weight (approx.)	11.5 kg
Heat level adjustment (approx.)	9-level adjustment 75 W - 3200 W equivalent
Pan-frying temperature adjustment (approx.)	5-level adjustment 140 °C - 230 °C
Deep-frying temperature adjustment (approx.)	7-level adjustment 140 °C - 200 °C
Congee mode	4 servings or 2 servings
Cooking timer	1 minute - 9 hours 30 minutes

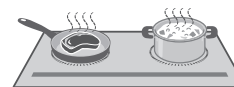

Using the both cooking zones simultaneously



Heating power may be regulated automatically to restrict overall power consumption.

- Heating power weakens without changing the heat level indication.
- The heat level decreases by one or several.
- The heat level cannot be increased, even if touching **+**. To increase the heat level, avoid using the both cooking zones together, or reduce the heat level of either of cooking zone.

Energy saving effect with ECONAVI

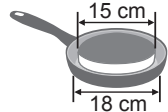
Comparative mode	 160 °C	 Level 4
Calculation condition		<ul style="list-style-type: none"> • Cook 3 pancakes in a row with Panasonic standard pan. • Fry one side for 6 min. and the other side for 2 min.
Power consumption (approx.)	Saves approx. 23 % 147.5 Wh	191.5 Wh

*Average integral power consumption calculated by comparison based on the actual data provided by Panasonic.

*Energy saving effect varies depending on the cooked volume, and size and material of the pan.

Panasonic®

使用 / 安裝說明書

IH 電磁爐
家庭用

型號 **KY-E227E**

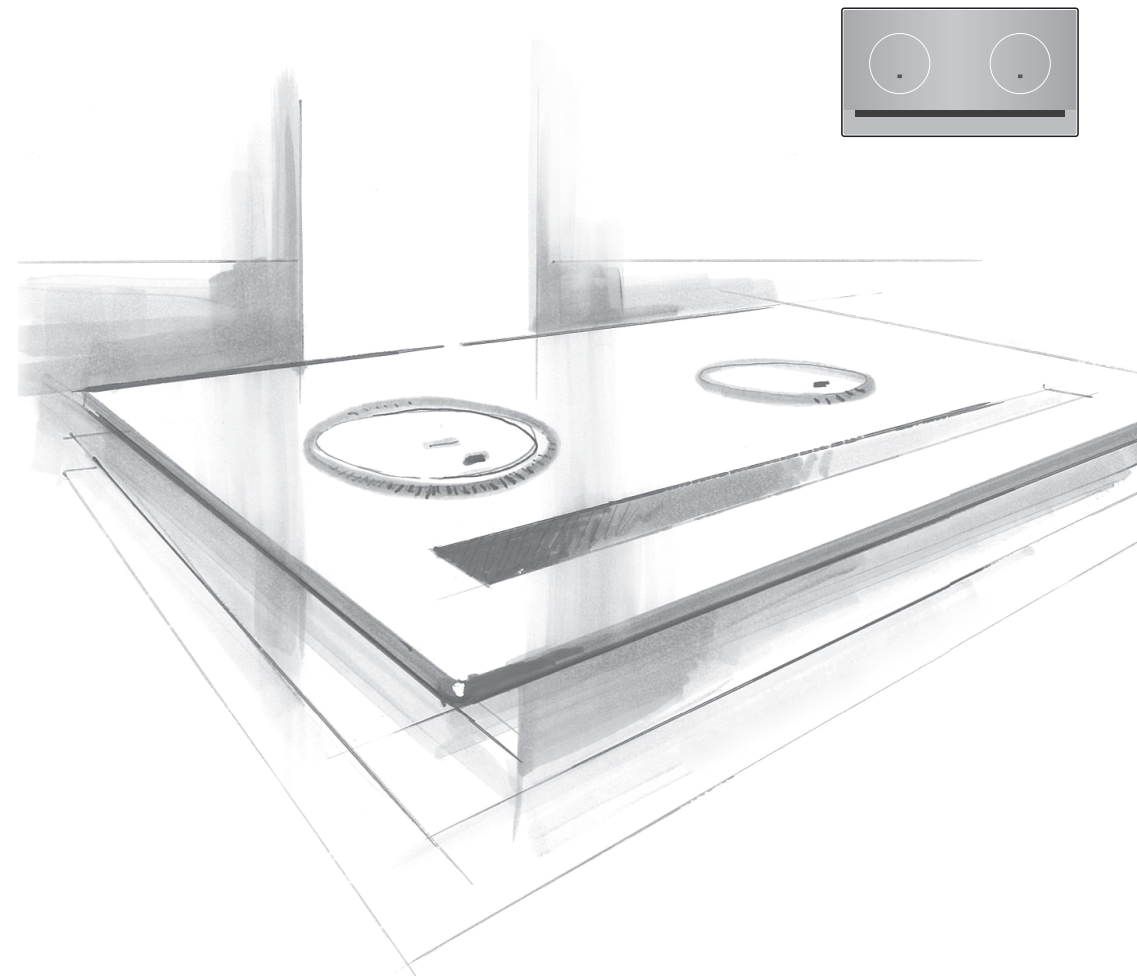
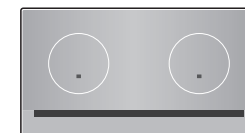

Panasonic Corporation
網站：<http://panasonic.com>

© Panasonic Corporation 2019

日本印刷

感謝您購買本 Panasonic 設備。
本設備的用途只限家庭使用。
本設備可採座檯式或嵌入式等安裝方式。
請在使用本設備前仔細閱讀本說明書。
使用 / 安裝說明書和保修證請妥善保管，以備將來不時之需。

中文

 ZY02HG371
H0719M1119

IR 感應器讓料理輕鬆無煩惱

目錄

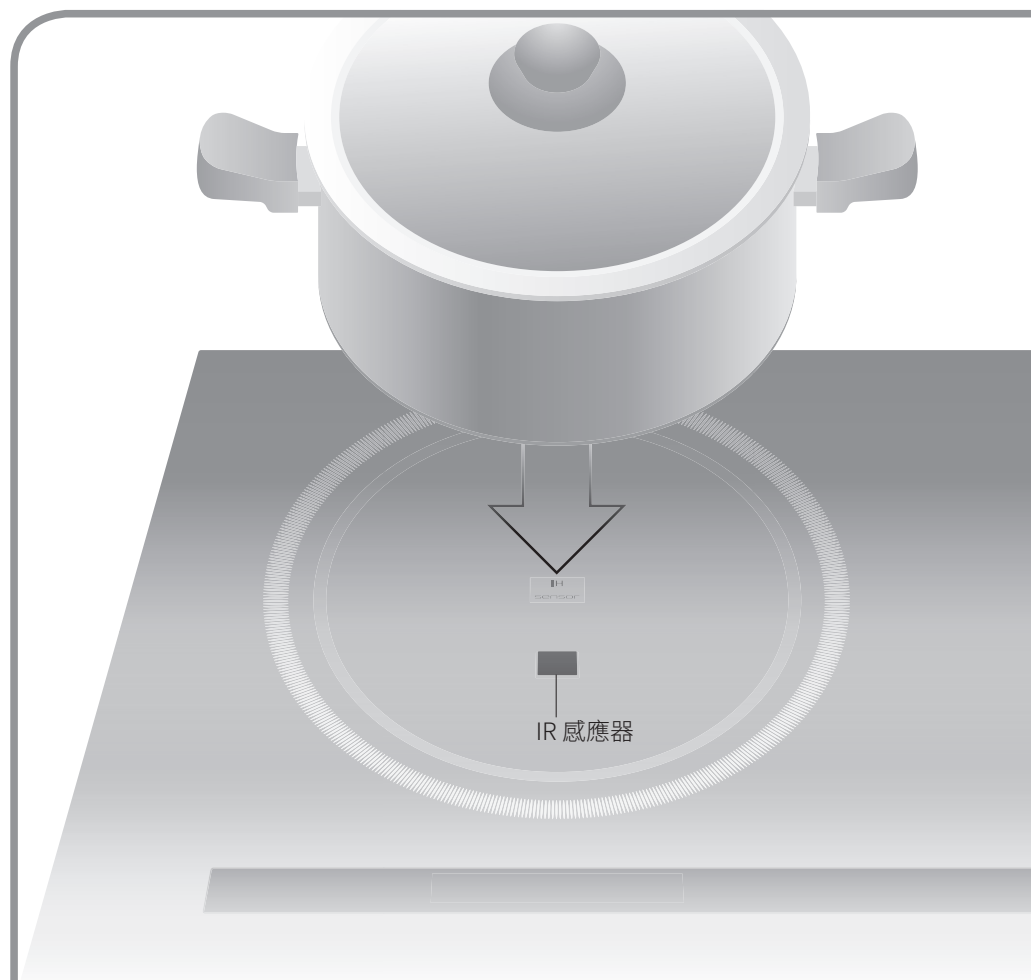

鍋具需放在 IH 爐頭中央。

鍋具必須完全覆蓋指定區域，IR 感應器才能正常運作。

IR 感應器有什麼功用？

除了可防止過熱，並在加入食材導致溫度下降時，可以回復到原本的火力。



煎炸功能

不會因過熱而燒焦，
烹調出美味佳餚。



油炸功能

自動調節溫度，令食物酥脆
可口。

IH (磁應加熱) 特點

安全

無火，烹調過程流暢
且舒適，室溫不會大
幅升高



乾淨

平滑面板，
容易清潔

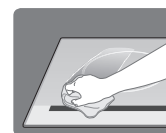

高效

高效能加熱，
省電愛地球



IH 烹調原理

磁場感應線圈產生的磁力線通過金屬
器皿會感應渦電流，接著鍋具就會因
電阻產生熱能。

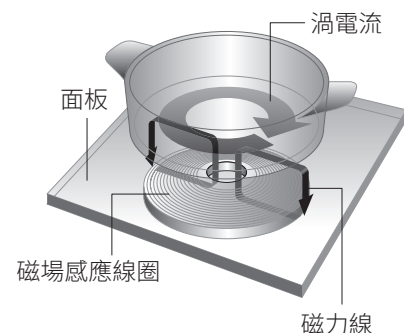

安全注意事項	4
一般注意事項	7
-安全功能	7
零件名稱/功能	8
適用鍋具	10

基本操作	12
加熱功能	13
煎炸功能	14
油炸功能	15
煮粥功能	16
正數計時 / 計時功能	18

清潔	19
錯誤訊息顯示	20
故障排除	22
規格	31

安裝	25
(適用於安裝人員)	

準備

使用

維護

安裝

安全注意事項

警告

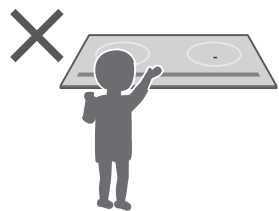

本產品不適合供下列人士(包括小孩)使用:身體感官或心智能力退化者,或是經驗與使用知識缺乏者,除非有負責他們安全的人員在旁監督,或指示產品的使用方法,方可使用。請看管好兒童以免讓他們將產品當成玩具。禁止嬰幼兒接近本設備。

防止油溫過高而起火



- **警告:**在無人看顧的情況下,在爐台上烹煮油類十分危險,萬一不慎可能會引起火災。
- 預熱請設定 **6** 或以下火力。
- 油溫切勿過高。

確保 IR 感應器能正常運作

- 鍋具完全覆蓋感應器。

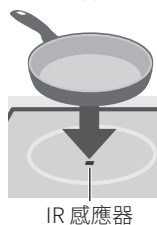

IR 感應器

- 擦掉水滴。



油炸烹調:

- 使用 。

- 遵守油量指示。

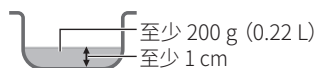

避免突沸導致受傷或燙傷



液體可能會飛濺出鍋外。

- 液體加熱前先適度攪拌。



防止火災、爆炸或觸電



- 勿施加過大壓力。面板可能會破裂。



- **警告:**萬一面板破裂,請勿以手觸碰。請關閉主電源開關,以免觸電。

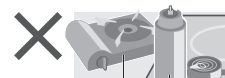

攜帶型煤氣爐
煤氣罐
罐頭

- **潛在火災危險:**請勿在烹飪面板上放置物品。
- 請勿將易燃材料放置於設備附近。
- 使用完畢後,請使用控制功能關閉設備,切勿過度依賴鍋具檢測器(安全功能)。
- 長時間不使用設備時,請關閉斷路裝置。
- 請勿自行拆卸、維修或改裝設備。

避免受傷或燙傷



注意:高溫表面

- 請勿觸碰面板。

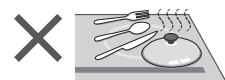

- 刀叉、湯匙、鍋蓋和鋁箔等金屬物品容易導熱,因此不應置於爐台表面。

如遇到故障或損壞

- 可聞到燒焦味。
- 觸碰面板時有觸電的感覺。
- 面板破裂。
- 電線過熱。
- 移動電線時電源關閉。

- 1 電源
- 2 斷路裝置
- 3 撥打電話



如果電源線破損,須委由原廠、服務代理或合格人員更換,以免發生危險。

安全注意事項



注意

防止火災或意外發生



- 如您佩戴醫療裝置 (例如心律調節器), 請向醫生諮詢。
本設備可能會影響醫療裝置的運作情形。

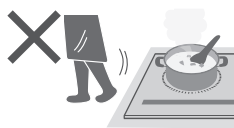

- **注意:** 烹調過程需在旁照看。即使是短時間烹煮, 仍需有人持續監看。
- 請勿將本設備用於烹飪之外的其他用途。



- 請勿將紙巾或碟抹布墊在鍋具底下。



- 油炸烹調:
- 如果油冒煙, 請  關閉。
 - 油炸時, 請勿使用其他設備將油預熱。油溫控制系統會無法正常運作。

避免受傷或燙傷



- 請勿將鍋具放在不穩固的平面上。
- 油炸烹調:
- 請勿將臉靠近鍋具。

熱油噴濺

避免鍋具損壞



- 請勿空燒鍋具。
- 請勿將食材過度加熱。

一般注意事項

- 請勿將下列物品放在面板上或附近。

- 產生雜音、資料遭抹除或損壞。
- 產生的電磁波會損壞設備。

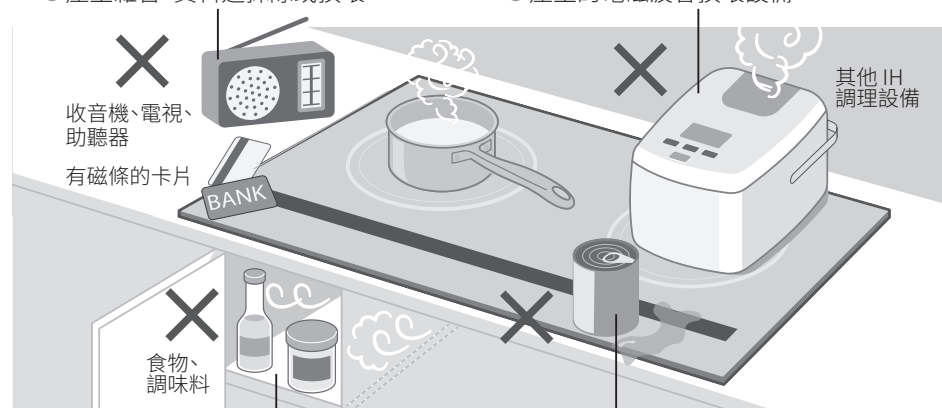

- 釋放的熱量可能會使其變質。
- 操作面板按鍵可能會故障。

- 本設備不對應外部計時功能或單獨遙控系統。

- 請勿擋住或堵住。

- 過濾器堵塞檢測會啟動, 可能導致設備自動關閉。

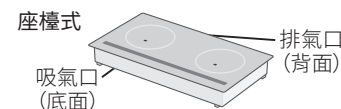

安全功能

停止加熱。

- 鍋具檢測功能 (頁碼21)
- 小物件檢測功能 (頁碼21)
- 空燒自動斷電功能 (頁碼20)
- 自動斷電功能 (頁碼22)

加熱功率降低。

- 鍋具過熱保護功能 (頁碼23)
鍋具底部過熱時會自動調降加熱功率。

主電源關閉。

- 主電源自動斷電功能
如在開啟電源狀態大約1分鐘內無操作, 主電源開關會自動關閉。

面板過熱時會亮起。

- 高溫警示 (頁碼9) 

鎖定所有操作。

- 兒童安全鎖 (頁碼9) 

零件名稱/功能

紅色光圈燈

- 加熱時亮起，亮度會按照火力大小變動。
- 即使停止加熱或關閉主電源開關，如果面板未冷卻，警示燈仍會繼續閃爍。

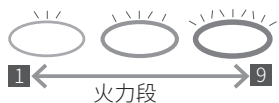

火力段

*為說明用途，以下圖說的顯示和指示燈狀態與實際使用時的狀態不同。

操控面板

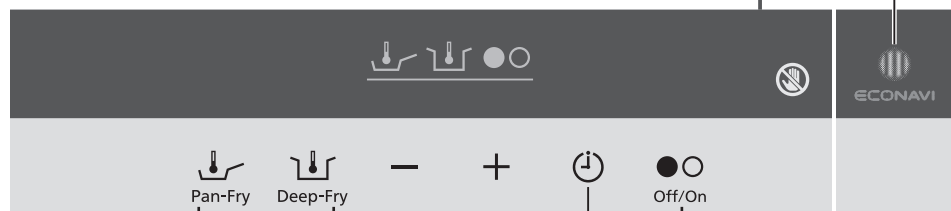

煎炸功能 (頁碼14)



設定溫度煎炸

- 正數計時: ✓
- 計時功能: ✓

油炸功能 (頁碼15)



設定溫度油炸

- 正數計時: ✓
- 計時功能: 無

加熱功能 (頁碼13)



基本烹飪

- 正數計時: ✓
- 計時功能: ✓

ECONAVI



- IR 感應器會快速偵測油溫或鍋具底部的溫度變化，調節設定的溫度。
- 即使鍋具大小、材質或食材量有所改變，調溫功能仍可發揮功效。
- 節能功效範例 (頁碼31)

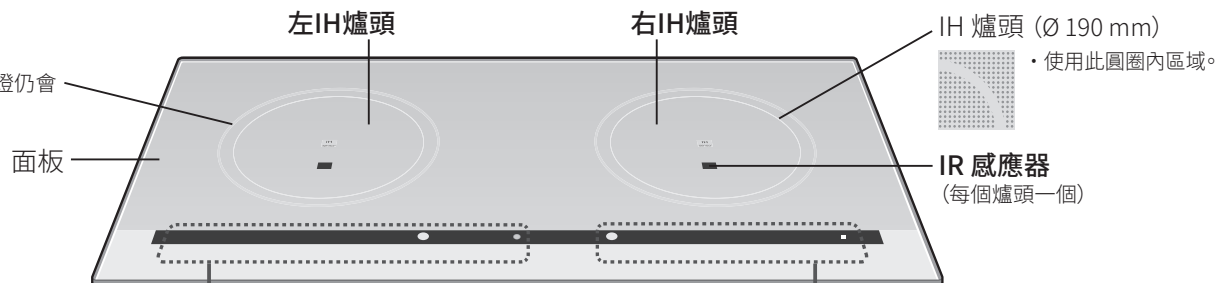

左IH爐頭

右IH爐頭

IH 爐頭 (Ø 190 mm)

- 使用此圓圈內區域。



IR 感應器
(每個爐頭一個)

面板

ECONAVI 燈

主電源指示燈

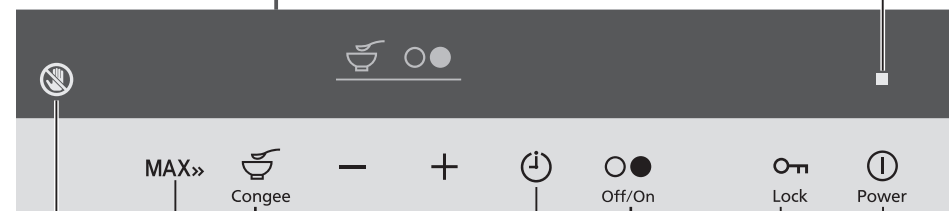

MAX»



Congee

計時功能 (頁碼18)

煮粥功能 (頁碼16)



自動烹粥

- 正數計時: 無
- 計時功能: 自動

快速加熱鍵

- 觸控即可將右IH 爐頭的火力設定為 9。使用左IH 爐頭時，火力會設為 8 以下。

加熱功能 (頁碼13)

兒童安全鎖按鍵

- 主電源開啟時:
- 鎖定所有操作



3 秒

- 解除鎖定









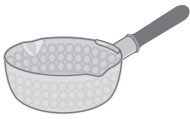

3 秒

高溫警示 (每個爐頭一個)

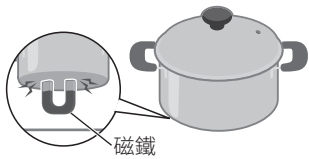
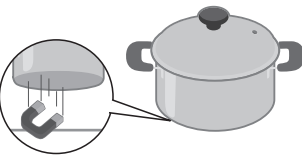
- 面板過熱時會亮起。
- 即使停止加熱或關閉主電源開關，如果面板未冷卻，警示燈仍會繼續閃爍。



適用鍋具

	✓ 適合使用	✗ 不適合使用
材質	<ul style="list-style-type: none"> ● 鐵/鑄鐵 	<ul style="list-style-type: none"> ● 鋁/銅 
	<ul style="list-style-type: none"> ● 搪瓷鐵 	<ul style="list-style-type: none"> ● 耐熱玻璃/陶瓷 
	<ul style="list-style-type: none"> ● 磁性不銹鋼 	<ul style="list-style-type: none"> ● 非磁性不銹鋼  <p>無法加熱或加熱功率降低</p>
鍋底形狀	平坦 	圓底 
		有腳 
		弧底  <p>3 mm 以上*</p>
		<p>*安全功能可能無法正常運作, 加熱功率可能降低, 或鍋具無法加熱。</p>
大小	 <p>12 cm 以上</p>	 <p>小於 12 cm</p>

■ 確認鍋具是否適用



注意事項

● 陶瓷

- 即使可用於磁應加熱：
- 設備可能會故障。
 - 加熱功率降低。
 - 停止加熱。

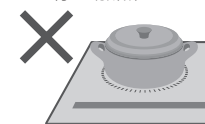

● 薄底鍋具

- 燒紅及/或變形



● 空搪瓷鍋

- 搪瓷塗層可能會融化及損壞面板。

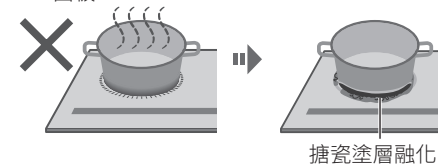

● 使用 或

視鍋具類型、材質、底部形狀和大小而定：

- 實際油溫與設定溫度可能不同。
- 預熱可能需要更久時間。
- 可能會停止加熱。

● 使用 有其他限制。(頁碼16)

基本操作

開啟電源

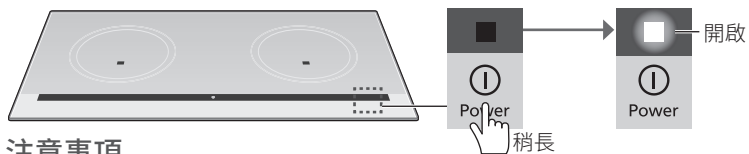

注意事項

- 如果 1 分鐘內沒有任何操作，電源會自動關閉。

烹調提示

- 鍋具完全覆蓋感應器。

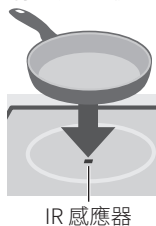

- 擦乾水滴再烹飪。



- 加熱超過 45 分鐘。

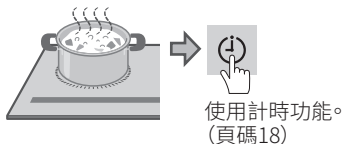

■ 使用 Deep-fry

為了讓溫度控制功能正常運作：

- 遵守油量指示。

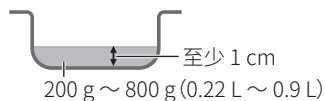

- 請勿使用下列油品。

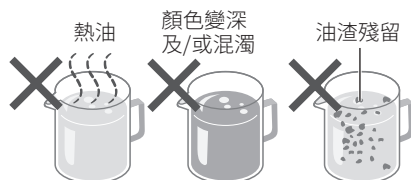

- 開始預熱後

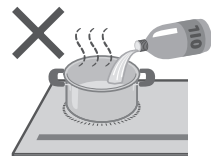

- 預熱時



加熱功能

基本烹飪

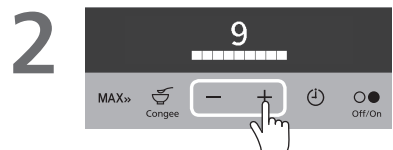
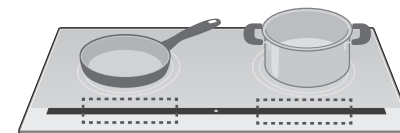
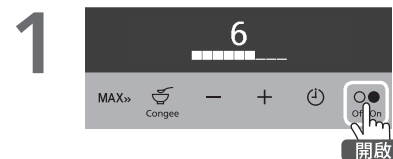

● 火力段範圍：1 ~ 9

● 迅速降低火力段：長按 -

● 將火力調到最大（頁碼9）：MAX

■ 正數計時 / 計時功能

🕒 (頁碼18)



火力段調校指示

低			中			高		
1	2	3	4	5	6	7	8	9
75 W	235 W	370 W	500 W	700 W	1000 W	1450 W	2000 W	3200 W
保溫			稍炆			煲滾、蒸或翻炒		
再加熱			炆			意粉、蔬菜		
小火煎炒*			清湯			蒸肉包		
漢堡排			熱水			快速煲滾		
大火煎炒*			牛扒			蔬菜		

● 加熱值會依鍋具材質而有所不同。
*建議使用「煎炸功能」。(頁碼14)

煎炸功能



設定溫度煎炸

1

開啟

2

預熱完成。

■ 正數計時 / 計時功能 (頁碼18)

3 烹飪完成後：

關閉

溫度調校指示

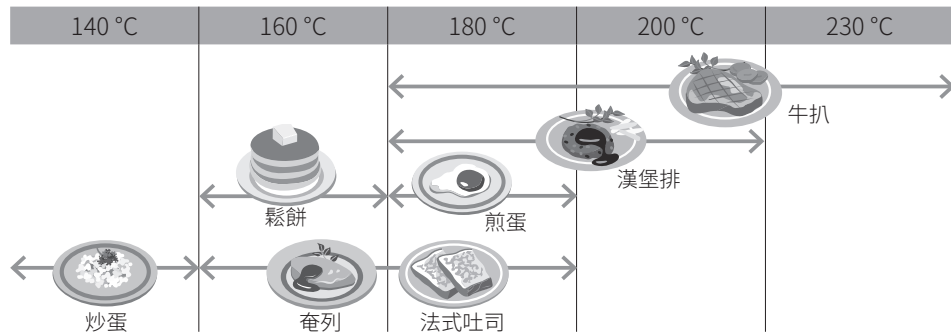

油炸功能



設定溫度油炸

1

開啟

2

預熱完成。

■ 正數計時 (頁碼18)

3 烹飪完成後：

關閉

溫度調校指示

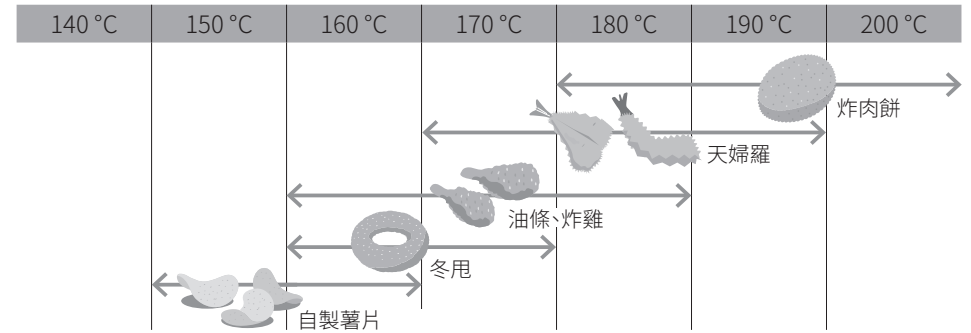

煮粥功能



自動煮粥

(4 或 2 人份)

- 使用適量的米和水。

	米	水
4 人份量	170 g (大約 200 mL)	2.4 L
2 人份量	85 g (大約 100 mL)	1.3 L

● 切勿使用熱水。

- 適用鍋具

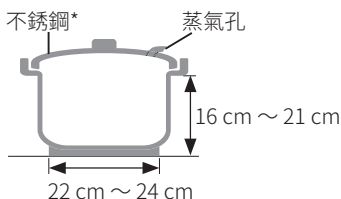

*若使用不沾塗層鍋具，粥可能無法如預期中稠。

- 將米洗淨後

瀝乾水。



- 烹煮時

蓋上鍋蓋。



- 當面板熱時



冷卻後觸控。

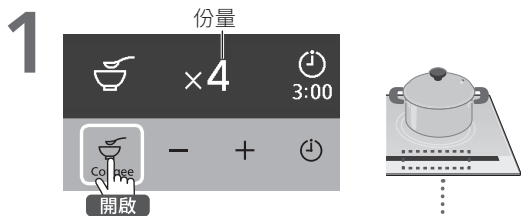

- 份量和烹飪時間可以在開始烹煮後 15 秒內更改。

■ 2 人份

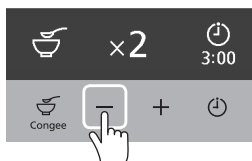

■ 煮較稀的粥

(縮短烹飪時間)

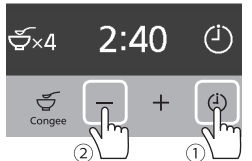

- 設定範圍：**2:00 ~ 3:00** (每單位 10 分鐘)
- 長按即可快速調校。

■ 取消烹煮

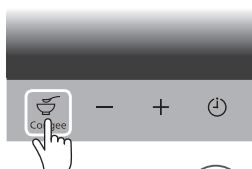

自動停止加熱。



雞肉乾瑤柱粥



材料	4 人份量	2 人份量
乾瑤柱	20 g	10 g
新鮮雞肉	200 g	100 g
米	170 g	85 g
水 (包括滲入的水)	2.2 L	1.2 L
薑 (切片)	1 片 (15 g)	1/2 片 (7.5 g)
鹽	茶匙 1	茶匙 1/2

* 配料：皮蛋、芫荽、蔥等

烹調方法

1 準備

- ① 泡水軟化。

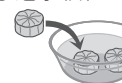

- ② 切成小塊。



乾瑤柱

● 步驟 2 需加入泡乾瑤柱的水。

- ① 切除雞皮和脂肪。



- ② 清洗後擦乾。



- ③ 抹鹽。



雞肉

米



洗淨後瀝乾。

2 將食材放入鍋中。



將表面抹平。



● 2 人份
雞肉切成可浸入水中的大小。

3 開始烹飪。

- ① 蓋上鍋蓋，開始烹煮。

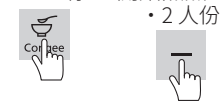

- ② 不時攪拌以免燒焦。



自動停止加熱

- ① 攪拌。依個人喜好
- ② 將雞肉撕成薄片。

注意事項

● 請勿縮短加熱時間。雞肉可能不會熟。

注意事項

- 煮滾時
讓蒸氣溢散。



- 室溫低時
粥可能不會太稠。

⇒ 繼續燉煮。

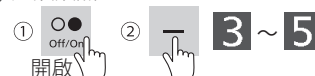

正數計時 / 計時功能

正數計時可用於 設定，而計時功能可用於 設定。

設定正數計時

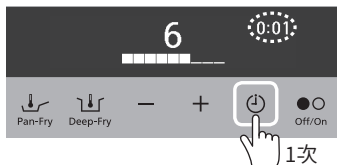

• 如要取消正數計時，請觸控 2次。

設定計時功能

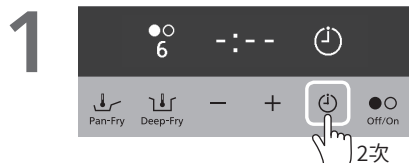

• 如 5 秒內沒有後續操作，計時功能將會取消。



• 設定範圍: **0:01 ~ 9:30**

• 長按即可快速調校。

• 設定時間:

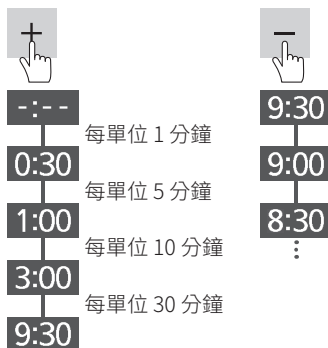

• 要取消計時功能

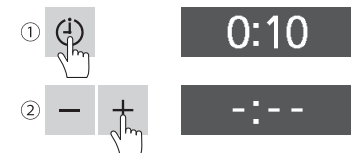

注意事項

- 正數計時不會關閉 IH 爐頭。
- 對於 ，計時功能在會預熱完成後開始運行。

清潔

設備應隨時保持清潔。

噴濺出來的食物或油一旦黏在設備上，就會很難清理。

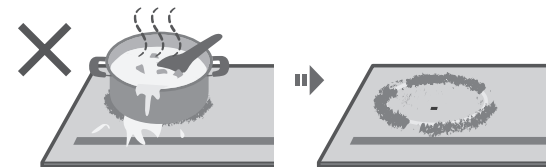

⚠ 注意

● 清潔前



等待冷卻。

● 請勿使用蒸氣式清潔用具。
水可能會侵入電子零件導致故障。



■ 輕微污漬

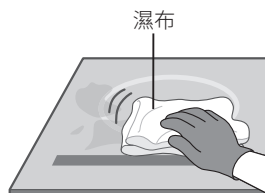

■ 油漬



■ 頑固污漬



注意事項

● 務必清除污漬。
• 污漬會燒焦並黏在面板上。





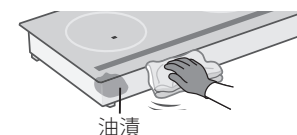

● 座檯式設備
擦去設備正面和側面的油漬。







錯誤訊息顯示



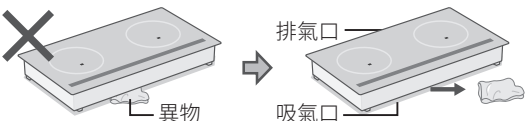
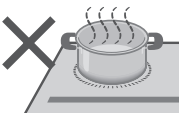

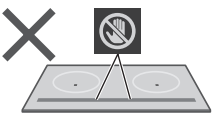
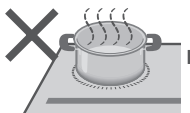
如出現以下任一錯誤訊息，請檢查原因並解決問題。

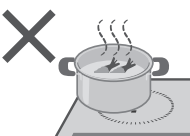
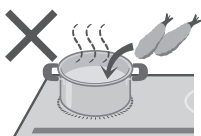
解決問題後，請觸控  或 ，清除錯誤訊息。

此外，觸控  可以清除 **U19** 訊息，觸控  則可清除 **U33** 或 **U34** 訊息。

訊息	可能原因
U04	<ul style="list-style-type: none"> ● 吸氣口及/或排氣口堵塞 
U13 U14	<ul style="list-style-type: none"> ● 空燒自動斷電功能 ● 鍋具空燒。  <p>*根據鍋具類型，或火力處於低段時，此功能可能無法正常運作。</p>
	<ul style="list-style-type: none"> ● 油炸時，使用過高火力預熱。   <p>務必使用油炸功能。</p>
U19	<p>當使用「煮粥功能」</p> <ul style="list-style-type: none"> ● 面板尚有餘溫 ● 鍋具空燒   <p>加入食材，待面板冷卻再開始烹煮。</p>
U33 U34	<p>當使用「油炸功能」</p> <ul style="list-style-type: none"> ● 加入超過 800 g 油 ● 鍋具不適用 (頁碼10) ● 擺放位置錯誤 ● 預熱時放入食材    

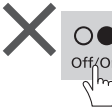
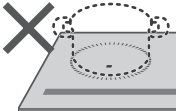
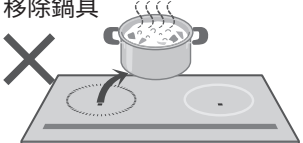
一旦排除下列錯誤原因，電磁爐會自動繼續加熱。

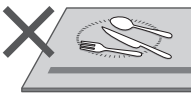
訊息	可能原因
U16	<ul style="list-style-type: none"> ● 操作面板上有污漬  <p>水、食材或異物</p>  <p>① ② 必要時重新設定設備。</p>
	<ul style="list-style-type: none"> ● 操作不當  <p>操作按鈕 超過 3 秒</p>
6	<p>鍋具檢測功能*</p> <ul style="list-style-type: none"> ● 沒有鍋具 ● 移除鍋具 ● 擺放位置錯誤 ● 鍋具不適用 (頁碼10)    
	<p>小物件檢測功能*</p> <ul style="list-style-type: none"> ● 金屬物品 













*發生上述情況時，電源會在 1 分鐘後關閉。



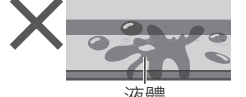

無法解決問題，或顯示 **H00** 錯誤

- 1 電源  關閉
- 2 斷路裝置  關閉
- 3 撥打電話 

*如需服務中心的聯絡名單，請參閱保修證。

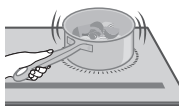
故障排除



狀況	可能原因
■ 電源	
主電源無法開啟。	<p>主電源無法輕易開啟是為了避免誤觸。</p> <p>→  稍長</p> <p>鎖定 (頁碼9) →  3秒 解除鎖定</p>
主電源關閉。	<p>主電源自動斷電功能</p> <p> 開啟 無操作超過1分鐘。 →  關閉</p>
烹煮時停止加熱。	<p>自動斷電功能</p> <p> 無操作超過45分鐘。 → 停止加熱。</p> <p>● 長時間燉煮：  →  使用計時功能。(頁碼18)</p>
■ 操控面板	
按鍵無法使用。	<p>● 指尖被覆蓋。 </p> <p>● 當使用設備的同時握住鍋具把手，可能會導致無法使用按鍵。</p>
	<p> 污漬 → ①  關閉 ② </p>
觸碰周邊區域時，按鍵會有反應。	<p> 液體 → ①  關閉 ② </p>

狀況	可能原因
■ 聲音與噪音	
加熱時發出噪音。	<p>視鍋具類型而定： • 發出多種聲音 • 握住把手時感覺震動 • 稍微移動</p> <p>→  這不是故障。請稍微移動或重新放上鍋具。</p>
主電源關閉後，仍可聽到風扇發出的聲音。	<p>加熱時取走鍋具，可能會聽到短暫金屬聲。</p> <p></p> <p>設備內部尚未冷卻，冷卻風扇會持續運作。設備冷卻後，風扇就會自動停止。</p>
■ 加熱功率	
加熱功率變弱。	<p>鍋具過熱保護功能</p> <p>加熱功率在不調校火力的情況下..... → 鍋具冷卻後，加熱功率就會恢復正常。</p> <p></p> <p>陶瓷 (頁碼10)  *即使陶瓷鍋具可以用於磁應加熱，但仍請不要使用陶瓷鍋具。</p>
同時使用兩個IH 爐頭： • 加熱功率或火力降低。 • 火力無法提升。	<p>加熱功率會自動調節，限制整體耗電量。(頁碼31)</p> <p>→ 若要調高火力，請避免同時使用兩個IH 爐頭，或調低任一IH 爐頭的火力。</p>



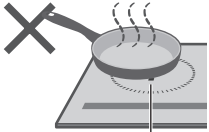
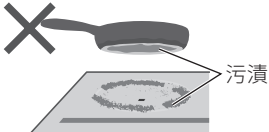
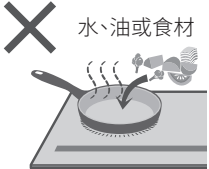
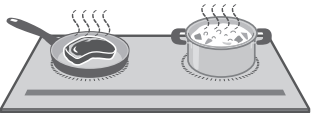

故障排除

狀況	可能原因
----	------

煎炸功能

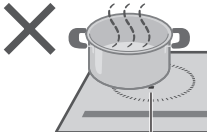
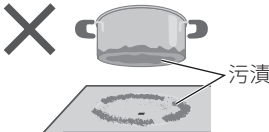
<ul style="list-style-type: none"> 預熱時間過長。 實際溫度與設定溫度不同。 	 <p>鍋具未覆蓋住 IR 感應器。(頁碼4)</p>	 <p>污漬</p>	
	<ul style="list-style-type: none"> ● 預熱時  <p>水、油或食材</p>	<ul style="list-style-type: none"> ● 如果同時使用右IH 爐頭，預熱時間可能會拉長。 	
	<p>根據平底鍋類型，平底鍋底部溫度可能與設定溫度不同。</p>	 <p>視需求調校溫度。</p>	

油炸功能

<ul style="list-style-type: none"> 預熱時間過長。 實際溫度與設定溫度不同。 	 <p>鍋具未覆蓋住 IR 感應器。(頁碼4)</p>	 <p>污漬</p>	
	<p>超過 800 g 油</p> 	<p>不適合的油品</p>  <p>熱油 顏色變深及/或混濁 油渣殘留</p>	
	<p>根據鍋具底部的類型、材質、形狀和大小，油溫可能與設定溫度不同，或預熱時間可能較長。</p>	 <p>視需求調校溫度。</p>	

安裝

(適用於安裝人員)

目錄

安全注意事項	26
尺寸	27
安裝位置	28
電氣工程	28
安裝設備	29
安裝後檢查清單	30

重要事項

- 請依照安裝說明書安裝本設備，否則設備效能可能會受到影響。
- 安裝人員有責任以正確方式安裝。未遵照說明書所導致的故障或意外，均不在保固範圍內。
- 更換本 IH 電磁爐後，務必委請具專業資格的煤氣技術人員封閉原本使用的煤氣裝置和管線。
- 請勿將爐灶安裝在櫥櫃下方。
- 安裝後，請確實測試。
- 向客戶說明如何正確使用本設備。
- 向客戶提供使用/安裝說明書，以供當地電氣監工使用。

安全注意事項



警告

避免火災、漏電、觸電或不當操作

- 如果附帶的電源線破損，須委託原廠、服務代理或合格人員到府更換，以免發生危險。
- 電氣工程應由經認證的電氣技師施工。
- 安裝前，務必關閉斷路裝置。
- 為 220 V/20 A 專用單相電路安裝電源接地漏電防護裝置，以免電線過熱。
- 本設備必須按照以下電機法規正確接地。
- 請勿將接地線接到氣體喉管、水管、避雷針地線或電話線。
- 務必正確連接電源線，以確保管線全面接受。
- 請勿踩踏設備，或將重物掉落在設備上。
- 請勿拆卸、維修或改裝設備。
(例如拆卸面板)



注意

避免火災、變形或變色

- 檯面請使用耐熱材質。
(耐熱程度等同或超過「熱固性高壓裝飾板」)
- 檯面請勿使用亮光材質。

尺寸

■ 俯視圖

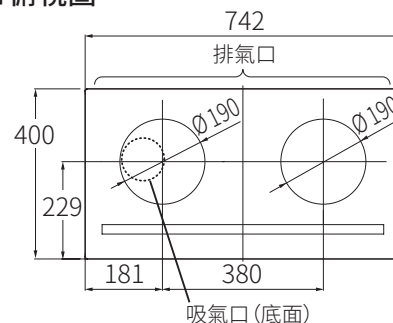

■ 正視圖

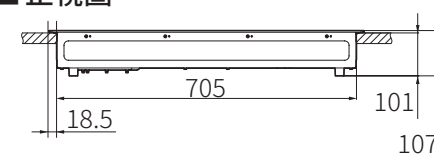

■ 側視圖

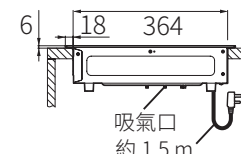

相關尺寸(嵌入式)

■ 檯面開孔

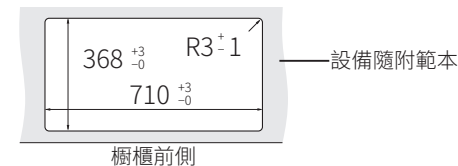

■ 櫥櫃

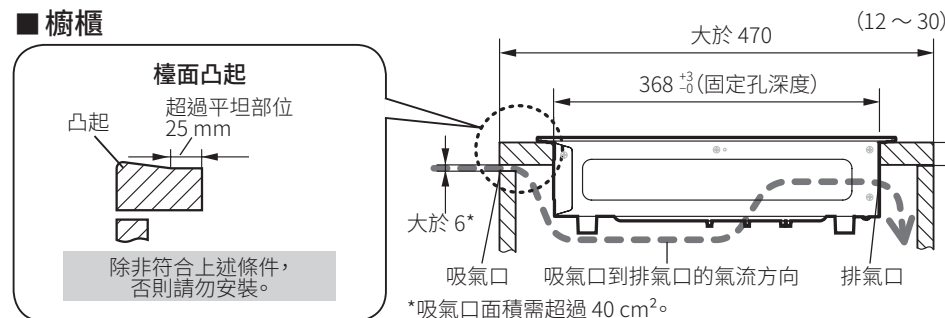

■ 如無通風部分的隔板已安裝

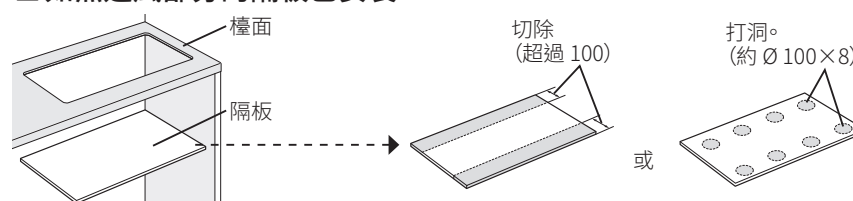

安裝位置

• 遵守相關安裝法規。

牆壁和天花板	嵌入式			座檯式		
	最小距離(單位:cm)			最小距離(單位:cm)		
	(A)	(B)	(C)	(A)	(B)	(C)
不可燃*1	0	70	0	1*2	70	0
可燃	5	100	5	5	100	5

*1 金屬、磁磚、磚頭等(包括金屬、磁磚、磚頭等材質的隔熱板)。

*2 設備背面設有排氣口。

電氣工程

- 遵守所在地的配線和接地安全法規。
- 請勿扭曲或壓住電源線。

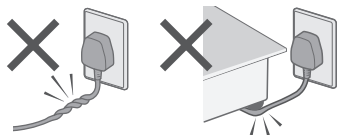

警告

- 提供插座電線供單極接地。

專用電路

- 單相 220 V/20 A (具斷路裝置)
- 室內電線:直徑至少 2.0 mm 的單條電線
- *牆壁插座(盒型)也可使用至少 3.5 mm² 的多股絞合線。

接地漏電防護裝置

- 額定電流:30 A
- 額定感應電流:30 mA
- *根據電氣配線規範,家中電線應加裝斷路裝置和接地漏電防護裝置。

牆壁插座

- 插座類型:  BS546 類型 (15 A)

• 安裝位置

嵌入式

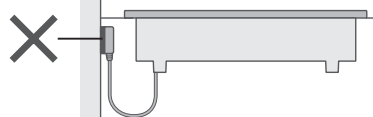

請將插座安裝在可以拔除插頭的地方。

座檯式

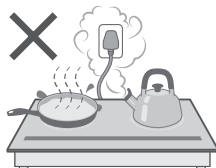

安裝設備

座檯式

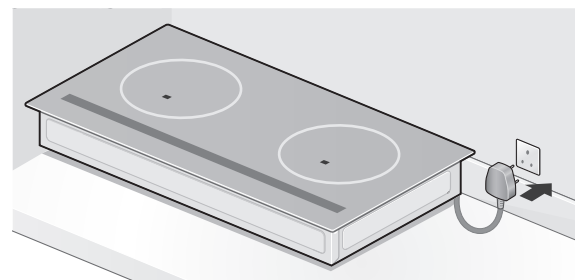

• 請勿隨意放置。

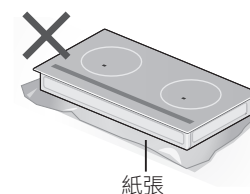

嵌入式

1 將插頭插進插座。

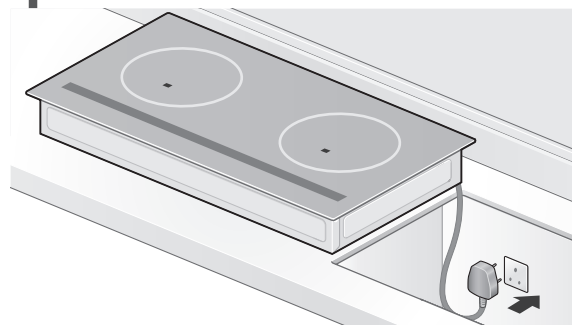

• 請勿重摔。

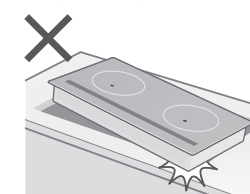

2 水平放入。

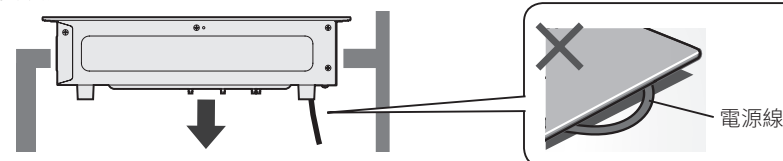

3 確認檯面和面板前後左右間沒有空隙。

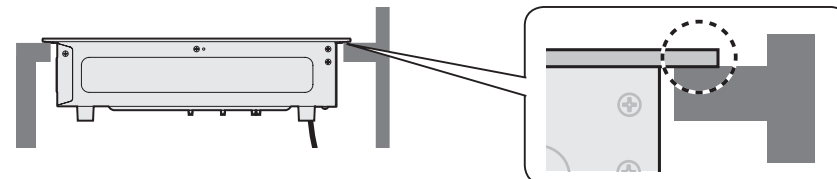

安裝後檢查清單

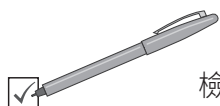

檢查下列項目，完成後請打勾。

<p>安裝</p>	<ul style="list-style-type: none"> ● 未傾斜 ● 乾淨 ● 安全放入 • 輕輕按壓，確定面板角落未翹起。 	<input type="checkbox"/>
<p>電氣工程</p>	<ul style="list-style-type: none"> ● 電源為單相 220 V。 ● 確實接地。 ● 接地漏電防護裝置已安裝。 	<input type="checkbox"/>
<p>電氣測試</p>	<p>1 檢查電源燈是否亮起。</p> <p>2 檢查顯示訊息是否閃爍。</p> <p>6 檢查顯示訊息是否閃爍。</p>	<input type="checkbox"/>

- 完成電氣測試後，請關閉IH 爐頭和主電源開關。
- 請將使用/安裝說明書及保修證交給客戶。

茲此保證設備已確實安裝完成。

安裝人員簽名

規格

電源	單相 220 V ~ 50 Hz
耗電量	3200 W
待機耗電量 (大約)	0.9 W * 關閉主電源開關的情況下
尺寸 (大約)	寬 742 × 深 400 × 高 107 mm
重量 (大約)	11.5 kg
火力段調校 (大約)	9 段調校 相當於 75 W ~ 3200 W
煎炸溫度調節 (大約)	5 段調校 140 °C ~ 230 °C
油炸溫度調節 (大約)	7 段調校 140 °C ~ 200 °C
煮粥功能	4 人份或 2 人份
烹飪時間設定	1 分鐘 ~ 9 小時 30 分鐘

■ 同時使用兩個IH 爐頭

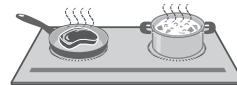

加熱功率會自動調節，限制總耗電量。

- 加熱功率在不調校火力的情況下降低。
- 火力下降一或多段。
- 即便觸控 +，火力仍無法提升。

若要調高火力，請避免同時使用兩個IH 爐頭，或調低任一IH 爐頭的火力。

■ ECONAVI 節能功效

比較功能	160 °C	4 段
測量條件	15 cm 18 cm	<ul style="list-style-type: none"> • 使用 Panasonic 標準平底鍋，連續煎 3 份鬆餅。 • 一面煎 6 分鐘，另一面煎 2 分鐘。
耗電量 (大約)	省下大約 23 % 147.5 Wh	191.5 Wh

*比較 Panasonic 提供的實際資料所計算而得的平均整體耗電量。

*省電表現會根據烹調量、平底鍋大小和材質而異。