

Panasonic®

Operating Instructions Refrigerator (Household use)

使用說明書 雪櫃 (只供家用)

English

中文

Model No./ 型號 **NR-C370GH-N3**
NR-C370GH-W3
NR-C340GH-N3
NR-C340GH-W3



NR-C370GH



NR-C340GH

Thank you for purchasing this Panasonic product.
Please read these instructions carefully before using this product.
Please keep this manual for future reference.

非常感謝您購買本 Panasonic 產品。
使用本產品之前，請先仔細閱讀下列使用說明。
請保留此說明書，以供日後使用。
本說明書附有安裝說明。

ECONAVI
INVERTER

Contents

Introduction	Safety instructions	3
Installation	Installation	6
	Choosing the right location	6
Operation	How to view and operate the Control panel	8
	To use all features	10
	Refrigerator compartment.....	10
	Vegetable compartment	11
	Freezer compartment	11
	Automation Ice maker.....	12
Appendix	Cleaning, removing and re-installing	14
	Cleaning	14
	In these cases?	16
	ECO NAVI Q&A	17
	Troubleshooting	18
	Specifications	21
	Separately sold parts	21

- This appliance is intended to be used in household and similar applications such as
 - staff kitchen areas in shops, offices and other working environments;
 - farm houses and by clients in hotels, motels and other residential type environments;
 - bed and breakfast type environments;
 - catering and similar non-retail applications.

Refrigerator compartment

Approx. 2 °C~7 °C

For regular storage of food and drinks or temporary storage of those to be served soon.

Freezer compartment

Approx. -17 °C~-23 °C

For storage of frozen foods.

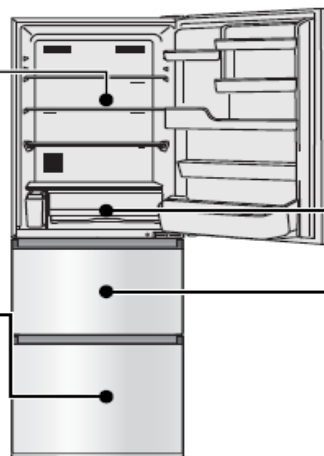

Chilled room

Approx. 0 °C~2 °C

For storage of meat, fish, processed foods (such as hams and sausages) or dairy products.

Vegetable compartment

Approx. 3 °C~8 °C





A rather high humidity keeps fruits and vegetables fresh and juicy.

This section explains by using the illustration of NR-C370GH

- Press the set button to control the temperatures of the refrigerator compartment and the freezer compartment. The temperatures of the chill compartment and the fruit and vegetable compartment will change when setting the temperature of the refrigerator compartment.

Safety instructions

What the symbols mean.

 Do not	 Make sure you do this	 Indicates the appliance must be earthed to prevent electric shock
 Do not take apart	 Warning; Risk of fire / flammable materials	



異丁烷
iso-butane

English



Indicates risk of death or serious injury.



This appliance is not intended for use by persons (including children) with reduced physical, sensory or mental capabilities, or lack of experience and knowledge, unless they have been given supervision or instruction concerning use of the appliance by a person responsible for their safety. Children should be supervised to ensure that they do not play with the appliance.

For power plugs and cords...



- Periodically remove dirt such as dust from the power plug.
- Plug into a wall outlet of the rated voltage on its own with the rated current and insert plug fully.
- When removing the power plug, hold the plug itself not the cord.
- Remove the plug when cleaning the refrigerator.
- If you do not intend to use the refrigerator for an extended period of time, then disconnect it. (Otherwise, it may cause a fire or electrical shock.)
- If the Power cord or plug of the appliance is damaged, it must be replaced by the manufacturer or its service agent or similarly qualified person in order to avoid a hazard.
- **WARNING:**When positioning the appliance,ensure the supply cord is not trapped or damaged.



- Do not use extension cords.
- Do not insert or disconnect the power plug into/from the wall socket with wet hands.
- Do not damage the power plug or cord. Do not cut or process the plug or cord; do not expose them to high temperatures; do not excessively bend, twist or pull them; do not place heavy objects onto them; and do not arrange them in bunches.
→ Contact your dealer for repairing the plug or cord.
- Do not push the rear of the refrigerator against the power plug.
- Do not use while the cord or power plug is damaged, or while the plug is not fully inserted into the outlet.
- **WARNING:**Do not locate multiple portable socket-outlets or portable power supplies at the rear of the appliance.

Stop using the refrigerator immediately and pull out the plug, if there is an abnormality or failure.

(Otherwise, it may cause smoke, a fire or electrical shock.)



Abnormality and failure examples

- Power cord or plug is abnormally hot
- Power cord is deeply cut or deformed
- There is a burning smell
- You can feel tingly electricity

Contact the dealer immediately for inspection and repair.

Introduction

On top of the refrigerator...



- Do not put anything.
(Otherwise, it may fall due to vibration and may cause injury or a fire.)
- Do not put anything on the top cover.
(Otherwise parts may be deformed and may cause electrical shock.)



When using...



- Do not hang or ride on the door.
- Do not apply water on the body or interior.
(Electrical insulation deteriorates and may cause shocks or fire.)
- **WARNING:** Do not damage the refrigerant circuit.
(The flammable refrigerant may catch fire and lead to an explosion.)
- Do not touch the mechanisms above the ice-making tray.
- Do not remove the ice-making tray when the ice making function is operating.
- Do not store flammable items in the refrigerator.
- Do not store explosive substances such as aerosol cans with a flammable propellant in this appliance.
- Do not store chemicals or scientific specimens.
- Do not spray combustible chemicals near the refrigerator.
- **WARNING:** Do not use electrical appliances inside the food storage compartments of the appliance, unless they are of the type recommended by the manufacturer.
(If the refrigerant leaks, then it may catch fire due to sparks on the contacts.)
- **WARNING:** Do not use mechanical devices or other means to accelerate the defrosting process, other than those recommended by the manufacturer.



- **WARNING:** Fill with potable water only.
- Children should be supervised to ensure that the refrigerator should be used properly.

When installing...



- **WARNING:** Keep ventilation openings, in the appliance enclosure or in the built-in structure, clear of obstruction. (P. 6)



- Ensure that the refrigerator is plugged into an earthed mains socket.
Do not plug into an unearthed mains socket. (3-pin plug)



- Do not install the product in locations exposed to water.
- Do not fill the gaps around the refrigerator.
(If the refrigerant leaks, then it may catch fire.)

When dispose and recycling the product...



- When a concern exists for possible entry of a child during recycling, remove the door packing.
- Flammable gas is used for refrigerant.
And Cyclo-Pentane is used for insulation of this refrigerator.
When you throw away this unit, please discard it by proper method.
- The warning labels mentioned above should be kept throughout the life of the refrigerator.
This manual should be handed over to any person who would use or handle the refrigerator whenever the refrigerator would be transferred to another location and delivered to a recycling plant.

In case of emergency...

- Absolutely do not open the back cover.
- Do not absolutely disassemble, repair or modify the refrigerator.
(May cause injury, burn, or electrical shock.)



- If you detect a gas (such as city gas) leak, do not touch the refrigerator and open the windows to ventilate the kitchen.
- A flammable refrigerant is used. If you have damaged the cooling circuit (piping), open the windows to ventilate the kitchen and contact your dealer.
- Maintenance work must only be carried out at workshop by well-trained maintenance worker.
(Otherwise, it may cause an electrical shock, ignition or explosion.)



Indicates risk of injury or damage to property.

When storing food...

- Do not add a high impact on glass shelves.
(Otherwise, those glass shelves may break and you may be injured.)
- Do not allow foods to protrude from the glass shelf.
- Do not store food containers on the door shelves if they do not reach the bottom of the shelves.
(Food may fall and cause an injury.)
- Do not freeze bottles.
(If the liquid in a glass bottle is frozen, then the bottle may break and the liquid may leak out.)
- Do not touch frozen food or containers (especially metal), ice with wet hands.
(Otherwise, you may get frostbite.)
- Do not eat food that has an unusual odor or is discolored.
(Rotten food may cause illness.)

When opening/closing the doors...

- Do not open/close it if others come into contact with the refrigerator.
- Do not put your fingers in the gap on the side of the refrigerator compartment door when opening/closing the door.
- Do not place your feet under the bottom drawer.
(Otherwise, your toes may get caught.)
- Do not open or close the door with excessive force.
(Food may fall and cause an injury.)

**When cleaning...**

- Please be careful when you fit or remove a glass shelf.
(Dropping glass shelves may cause shelf damage or an injury due to bruising.)



- Do not place your hands or feet beneath the bottom of the refrigerator.
(The edges of the metal panel may cause an injury.)

When moving or transporting the refrigerator...

- Fix the refrigerator with adjustable legs on the flat and stout floor.
(Otherwise, the refrigerator moves or overturns and may cause an injury.)
- Apply protective covering, etc. to floors with a fragile surface.
- Hold the carrying handles and move the refrigerator with at least two people.
(Otherwise, your hands may slip and cause an injury.)



Installation

Choosing the right location

1. Place the refrigerator in the following locations.

- Locations free from heat and direct sunlight
Minimize reduction of cooling power, and prevent electricity waste.
- Well-ventilated locations with low humidity
Minimize rust and generation of condensation.
- Sturdy and flat floors
With carpet, tatami mats, or vinyl floors, deformation or discoloration may occur, so place a board underneath the refrigerator.
- Place the refrigerator away from other devices
Prevent noise and jammed image display on TVs and other devices.
- Locations allowing the power plug to be cleaned easily
Clean dust regularly.
(To prevent fire caused by dust.)
- Locations that allow a heat to dissipate.
The back surface may be fitted to the wall.
(Leave a space when vibration noise or discoloration dirt of wall occurs.)

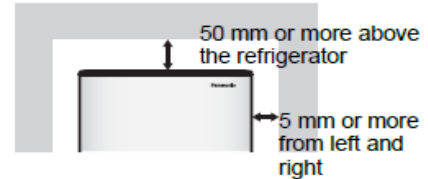

Before using the refrigerator for the first time.

- Wipe the inside of the refrigerator with a wet, soft cloth. (P. 16)
- Rinse the water supply tank, purification filter, and ice-making tray. (P. 17)

Fix the refrigerator.

- ① Remove the front grille.
Insert hands underneath the “↓” on both sides of the front grille and pull it out.
- ② Turn the adjustable legs (right and left) until they reach the floor to stabilize the refrigerator.
- ③ Reattach the front grille.

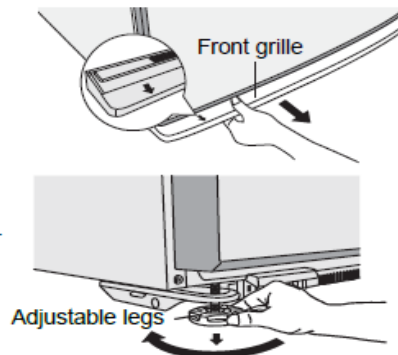

- If the refrigerator has not been stabilized completely, then you may hear rapping noises when the door is opened/closed. (This will not affect the performance.)
Install the refrigerator on sturdy and flat floors.

■ If the door is slanted downwards.

Turn the adjustable leg on the lower side, as shown in the diagram on the left, in order to adjust the level.

- The freezer/refrigerator doors may tilt within 4 to 5 days after installation due to the load of the food or adaptation to the floor surface. In this case turn the adjustable legs again to restore.
- If it does not help, then use an adjustment plates. (separately sold parts : P. 22)

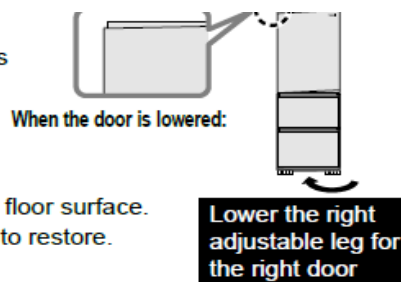

3. Plug into a wall outlet.

Plug into a wall outlet of the rated voltage on its own with the rated current and insert plug fully.

- The power plug can be plugged into an outlet immediately after installation.
- The surroundings and surfaces (side surfaces) of the refrigerator may become hot (approximately 50 °C to 60 °C when the ambient temperature is 30 °C) when the power is turned on, but this is not abnormal. (P. 20)
- If the power plug is removed, wait at least 7 minutes before plugging it back in. (P.18)

4. Cool the refrigerator interior.

- It may take approximately 4 hours to cool down the interior.
- It may take 24 hours or more to cool down the interior and achieve equilibrium in the summer, etc.
- Ice-making starts only after the interior has been cooled down sufficiently.
- Do not open/close the doors until the interior has been cooled down sufficiently. (Warm air flowing into the interior will block the cooling function.)

Requests

■ Do not peel the seals on the back.

They seal openings of a thermal insulation material.

Peeling them off causes a decrease in chilling.

If you have peeled one of them, then cut a cloth packing tape into a square and reseal.

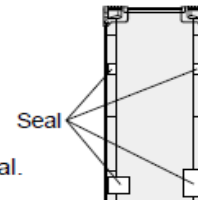

■ ECO NAVI Operation

ECO NAVI lamp is on during ECO NAVI operation.

ECO NAVI system operates only when the temperature of the refrigerator compartment is set as "4 °C" or "5 °C" and the temperature of the freezer compartment is set as "-19 °C", "-20 °C", or "-21 °C".

- Learns the lifestyle patterns of your family from opening and closing of doors, and predicts the time periods of infrequent use to perform ECO NAVI operation.

The refrigerator learns your lifestyle patterns from the previous 3 weeks, and uses what it has learned from the 4th week onwards. Therefore, the ECO NAVI lamp ON/OFF pattern may change from the 4th week onwards.



ECO NAVI lamp (Green)

- Performs ECO NAVI operation when it becomes dark* around the refrigerator, such as when you are asleep.
- The brightness of the lamp is lowered approximately 5 minutes after the lamp turns on.

ECO NAVI operation may not be performed depending on the usage state of the refrigerator. (P. 19)

* Darkness is detected by the light intensity sensor at approximately 3 to 10 lux or less.

■ For saving energy

- Do not stuff food into the compartments. That may interfere with the cold air flow. Provide sufficient space between foods.
- Open/close the doors minimum times. Minimizing the number of times the door is opened/closed prevents cool air from escaping and reduces the amount of wasted electricity.
- Do not block the cold air outlet with food items. If cool air does not spread into every corner of compartments, then the interior will not be sufficiently cooled and more electricity will be consumed.
- The cold air discharges out of the outlet of the duct at the back
- Store warm food and drinks after they have cooled. Otherwise, they will not only raise the interior temperature, but also affect the freshness of other foods.

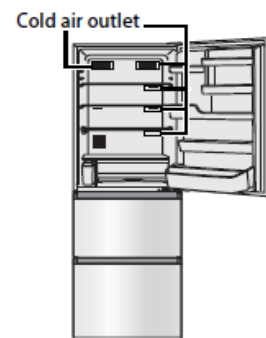

This section explains by using the illustration of NR-C370GH

How to view and operate the Control panel

- Normally, the indicators are off to save electricity.
 - When the power is turned on, all the function display lights will flash for 4 seconds .
The temperature display area flashes to show the temperatures of the refrigerator compartment and the freezer compartment, and the AG CLEAN icon lights up.

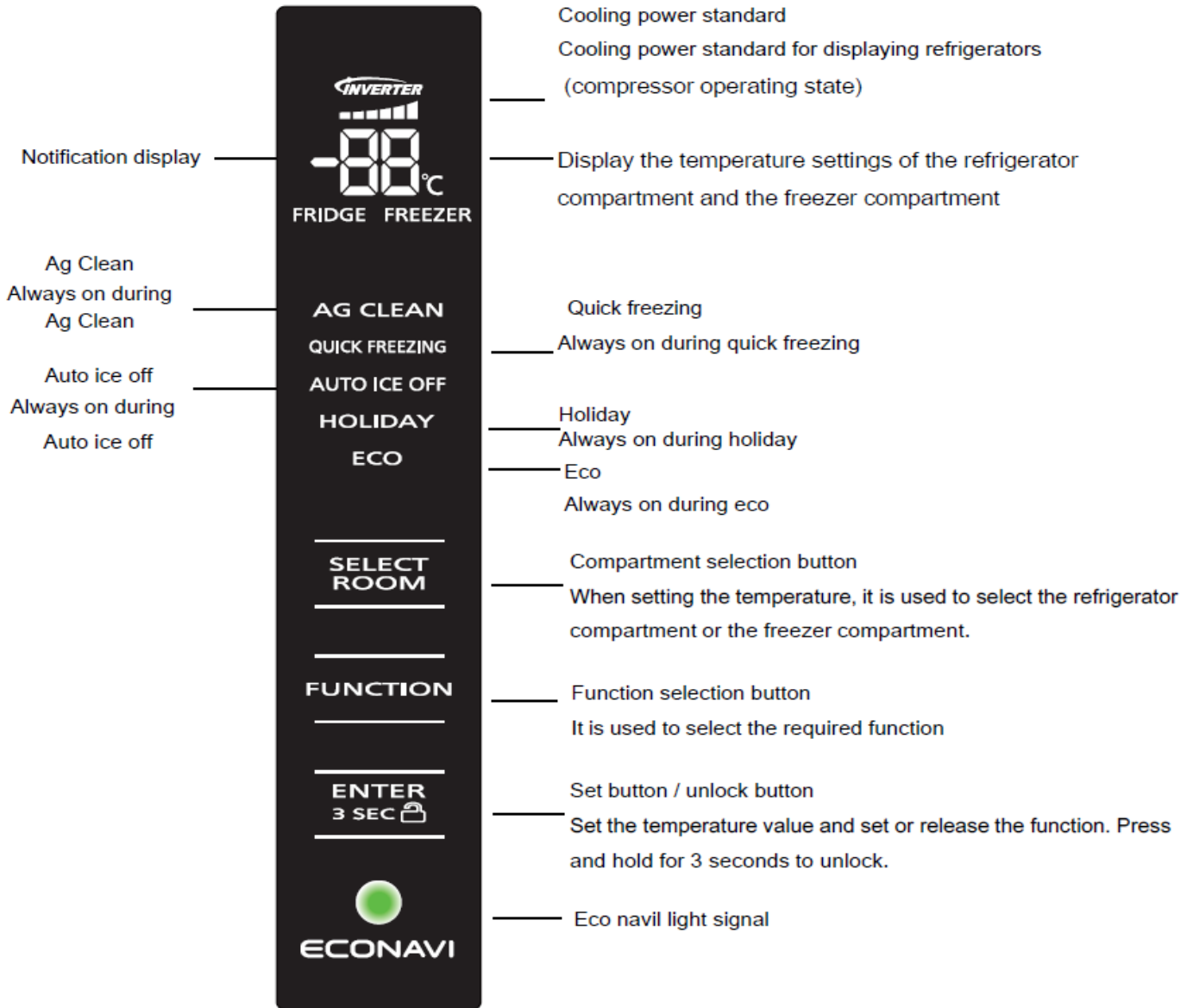



- Settings can only be changed when the refrigerator compartment doors are closed.

Adjust the temperature

- The set temperature range of the refrigerator compartment is 7 °C ~ 2 °C, and the set temperature range of the freezer compartment is -17 °C ~ -23 °C.
- If you want to change the refrigeration state, you can adjust the temperature.

Procedure

Select "FRIDGE" or "FREEZER"

- ① Press  and hold for more than 3 seconds, the control panel is unlocked.
- ② Press  to make the compartment to be set flash

Change the item to the desired setting.

- ③ Press  to set the setting value to be changed.

Display

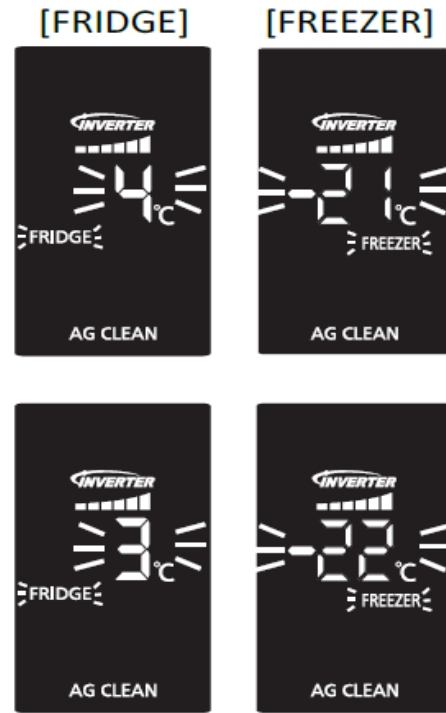

Notices

If there is no button operation in the unlocked state, the control panel will automatically lock after 10 seconds.

Operation

■ Set the function

Procedure

Select "FREEZER" or "FRIDGE".

① Press  and hold for more than 3 seconds,

the control panel is unlocked.

② Press  to select the function to be set

③ Press  to set the function to be set

Display



English

Notices

The AG CLEAN function does not need to be set, and the refrigerator automatically runs after it is turned on.

To use all features

Refrigerator compartment

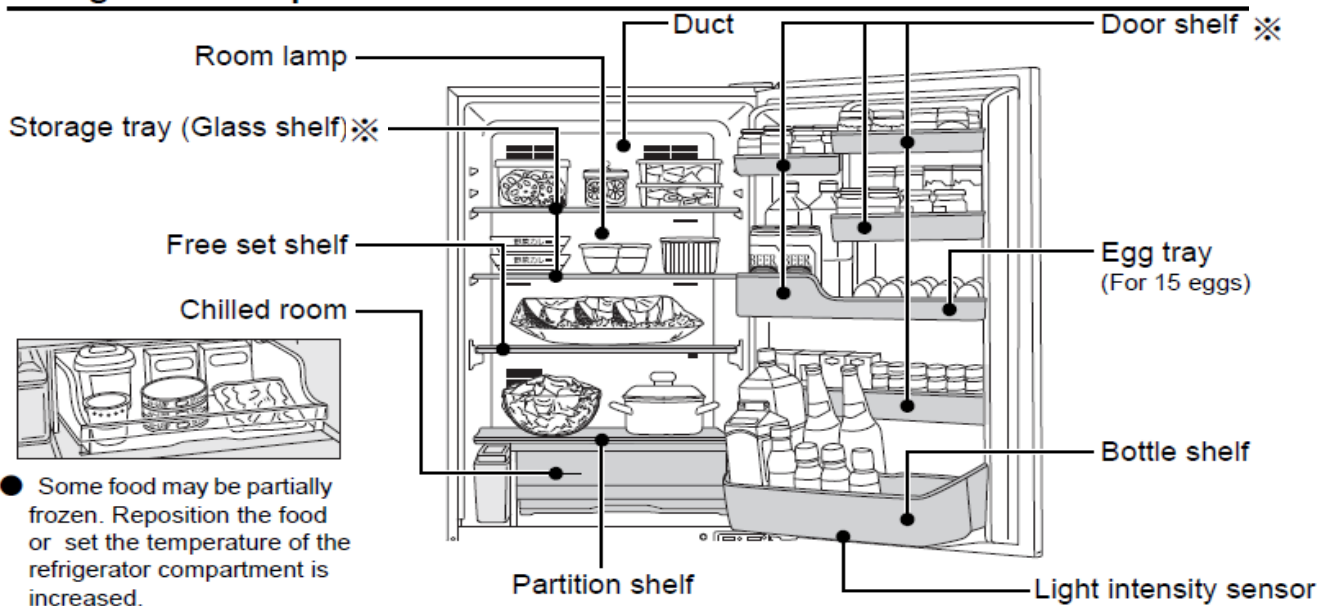

● Some food may be partially frozen. Reposition the food or set the temperature of the refrigerator compartment is increased.

• This section explains by using the illustration of NR-C370GH.

✳ The NR-C340GH has three door shelves and a storage tray(glass shelf).

How to use free set shelf

■ The free set shelf can be folded back on itself.

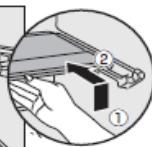
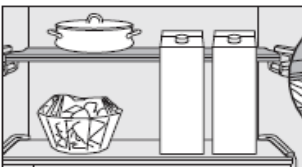

Raise the front half and bend it back. Then you can store tall stuff upright.

■ The folded shelf can be stood at the back.

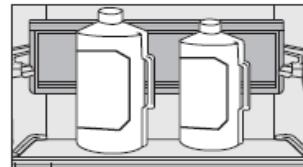

Then you can store large stuff.

To change the height of the storage trays (glass shelves)

■ Remove

Lift up the back edge of the tray out of the (two) hooks and slide the tray forward.

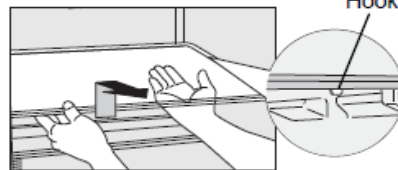

■ Installation

Slide the tray backward and put it on the hooks.

The following food must be put into a hermetically sealed container or wrapped for storage in a refrigerator!



In order to prevent discoloration of the compartment surfaces

- Cut citrus fruits (The plastic will be discolored.)



In order to prevent spread of the odor



- Green onions or other strong smelling vegetables (Odors will spread to other nearby food.)



HOLIDAY

TO use HOLIDAY

English

- ① Press  and hold for more than 3 seconds, the control panel is unlocked.
- ② Press  to make sure only **HOLIDAY** flicker.
- ③ Press  the setting is completed after the beep sound. (**HOLIDAY** Light up.)

Notices

- After the holiday function is selected, the LED lamp in the refrigerator compartment does not light up, and the temperature of the refrigerator compartment cannot be displayed and set.
- The holiday function can be used when the refrigerator compartment is not in use. After the holiday function is selected, foods such as fruits and vegetables that are difficult to store at room temperature must be taken out to avoid spoilage or mildew of the foods, which may contaminate the inside of the refrigerator.

Vegetable compartment

Wrap vegetables or fruits in plastic wrap to keep them from drying out.

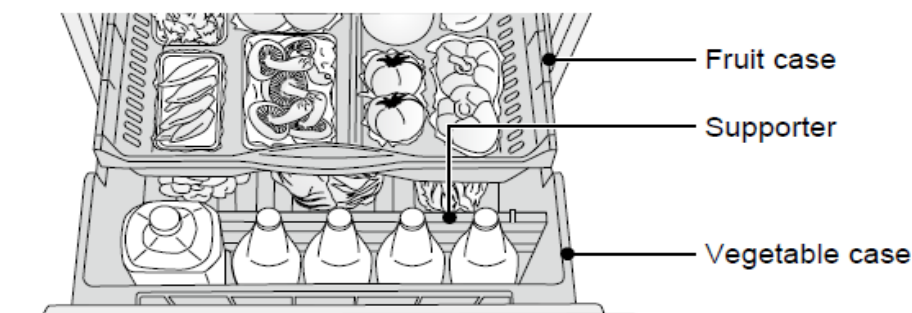

Freezer compartment

[QUICK FREEZING] setting makes it possible to freeze left-over food or rice instantly and keep it tasty.

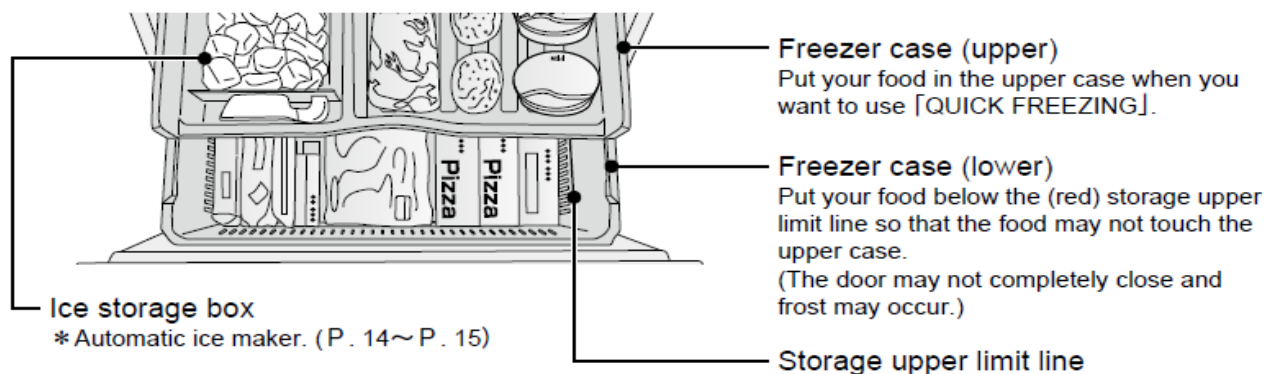



Ice storage box
* Automatic ice maker. (P. 14~ P. 15)

Three conditions of delicious freezing

1. Quickly freeze food in thin and small portions!
2. Tightly wrap!
3. Do not refreeze!



QUICK FREEZING To use [QUICK FREEZING] (Freezer compartment upper case)

- ① Press  and hold for more than 3 seconds, the control panel is unlocked.
 - ② Press  to make sure only **QUICK FREEZING** flicker.
 - ③ Press  the setting is completed after the beep sound. (**QUICK FREEZING** Light up.)
- [QUICK FREEZING] setting automatically ends in a maximum of fifty hours
(When [QUICK FREEZING] is set ON during defrosting, it starts after the defrosting and may end in longer than fifty hours)
 - In order to stop [QUICK FREEZING] in the middle, repeat the same operation as ① to ③ above.

Automation Ice maker

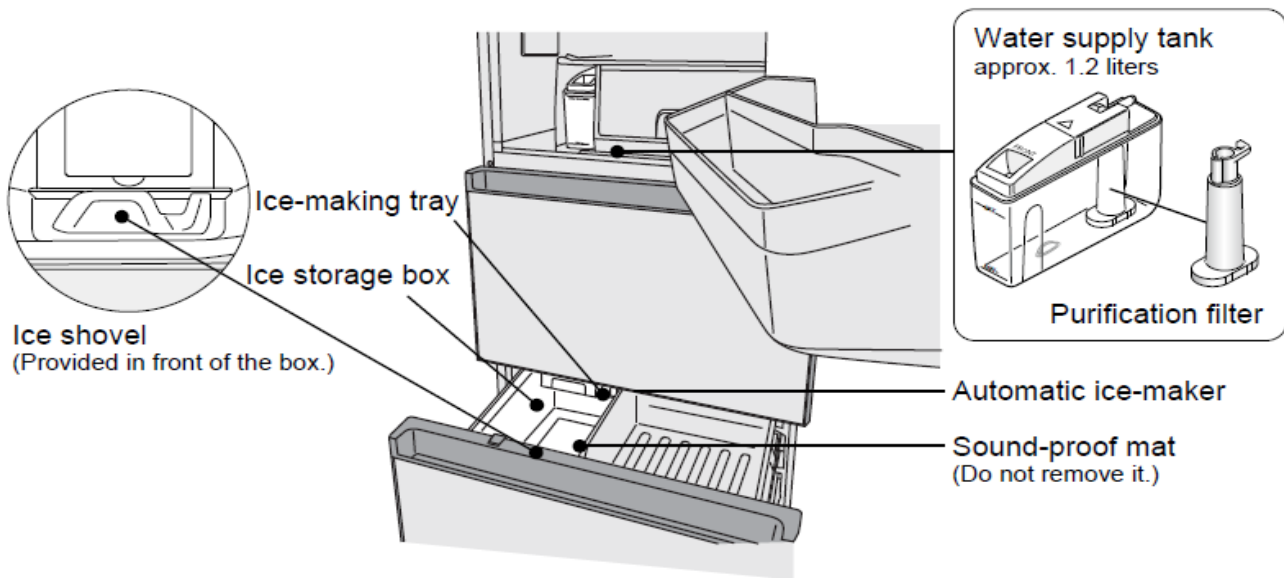

To use the automatic ice maker in comfort

Please use only the drinking water for auto ice making.

Clean the water supply tank and the ice-making tray with water frequently. (P. 17)



When the following water is used, wash the water supply tank frequently! (P. 17)



Do not put liquids such as the following into the water supply tank. (These may damage the ice compartment or cause ice cubes stick to each other.)

The hardness of water must be 100 mg/L or less.



Drinking water



Juice, etc.



Sports drinks



Carbonated drinks



Hot water

Requests

- Do not slam the ice compartment door open/close. (Ice may drop to the freezer compartment case or into other places.)
- Do not pour water directly into the ice-making tray to make ice. (This may cause damage to the icemaker or ice cubes may stick together.)
- Do not pour water directly into the ice storage box to make ice. (Otherwise, the ice storage box may break.)
- Drinking water-hardness of water must be 100 mg/L or less. The minerals may appear as white floating particles. They are not harmful.
- Do not put food or other items into the ice compartment. (Otherwise, the amount of ice cannot be correctly detected and auto ice making may be stopped.)

Notice

- When you first use the ice compartment, odor or dust may be on the ice-making tray etc. Please throw away the first lot of ice.
- Auto ice making operation stops automatically when the box is filled with ice cubes. This condition cannot be detected in the following cases.

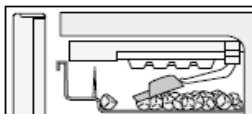

The ice shovel left in the ice storage box hits the ice detection lever.

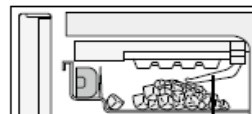

Ice cubes forming a mound hit the ice detection lever.

Ice detection lever
(When pressed, stops the auto ice making function.)

Ice can be made in approx. 2 hours!

To make ice

- ① Take out the water supply tank
Add water if the level is below the "MIN" line.
(Replace the water in the water supply tank at least once a week.)

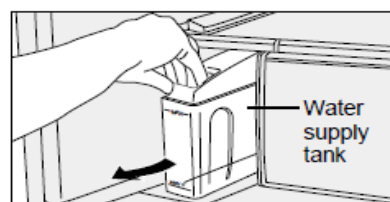

- ② Fill with water
Add water up to the "MAX" line.

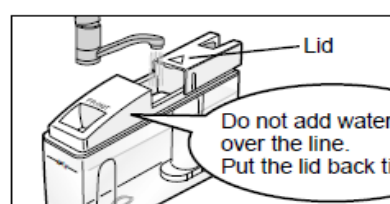

- ③ Install water supply tank
Hold the water supply tank horizontally,
Confirm the direction of the tank and install securely.
(If the tank is inclined, water may be spilled)

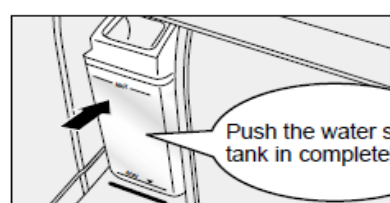

However, it will take longer in the following cases.

- When the refrigerator is used for the first time.
(It may take 24 hours or more because the auto ice making function will start only after the interior has cooled down sufficiently.)
- When the doors are opened frequently.
- When the door is ajar.
- When a large quantity of food is stored at once.
- When the ambient temperature is low in winter, or it is high in summer.
- When a power failure occurs.
- The washable ice-making tray has been cleaned. (P. 17)

AUTO ICE OFF To stop auto ice making

Stop the auto ice making if you do not want to make ice, and before cleaning the ice-making tray.

- ① Press **ENTER** and hold for more than 3 seconds, the control panel is unlocked.

Requests

- ② Press **FUNCTION** to make sure only **AUTO ICE OFF** flicker.

- During the beeping, do not open the door of the ice compartment.
(The auto ice making process cannot be stopped.)
- When you stop the auto ice making for a long term, empty the water supply tank and clean it. (P. 17)

- ③ Press **ENTER** the setting is completed after the beep sound.

Notice

(**AUTO ICE OFF** Light up.)

- In order to set the auto ice making ON again, repeat the same operation as ① to ③ above.

- If some ice is being made when you stop the auto ice making, it will be released after the auto ice making is again set ON.

Cleaning, removing and re-installing

Conduct periodic cleaning and maintenance to ensure that the refrigerator will be kept clean and that it will continue to operate for a long time.

Before cleaning or conducting maintenance, be absolutely sure to disconnect the power plug from the power outlet. Do not connect or disconnect the power plug with wet hands. Doing so may result in an electric shock or injury.

Cleaning

Wipe off easily removable dirt using a cloth dipped in lukewarm water.

Wipe off stubborn dirt using a cloth dipped in some diluted neutral detergent used in the kitchen.

Then take up the remaining detergent using a cloth dipped in lukewarm water.

To complete the cleaning, be absolutely sure to wipe the surfaces dry to take up the remaining moisture.

Attention

Do not use the following items for cleaning:

- Alkaline cleaning agents (these may dissolve the plastic parts).
- Abrasive cleaners, soap powders, very hot or boiling water, brushes, acids, benzene, paint thinners, alcohol, etc. (these may mar the surfaces, paint and plastic parts).
- Wipe off the control panel on the refrigerator compartment door and the surface of doors with a wet, soft cloth. Then wipe off with the dry cloth to finish up.

Storage tray (Glass shelf) / Free set shelf

Once every three months

Storage tray (Glass shelf)

Unhook the protrusion at the back of the tray and then pull it out.

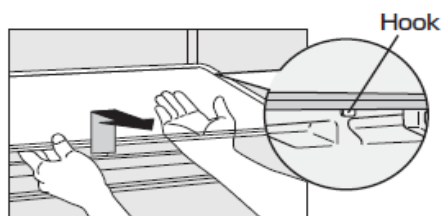

Free set shelf

Put the front half of a tray on the back of the tray and pull out it obliquely upward.

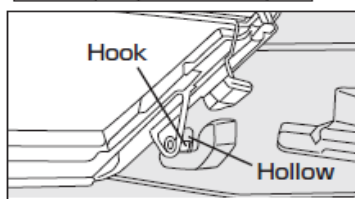

Attention

- The trays are made of glass and heavy. Please handle them with care so that they do not drop and cause damage or injuries.

Case

Once every three months

Fruit case / Vegetable case / Freezer case (upper)

Pull out at an angle.

Pull out the door as far as possible, and pull out at an angle while lifting up the front.

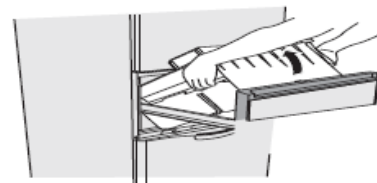

Freezer case (lower)

- ① Lift the door up and pull it out.

Put it on the floor.

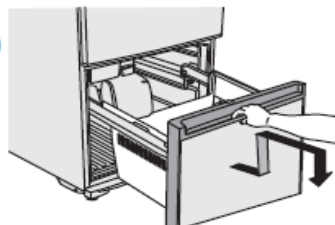

- ② Take out the lower case upward.

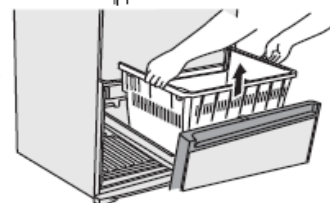

Requests

- The contact sections of the drawer rails have been coated with lubricant. Do not wipe it off.
- When the top case in the freezer compartment or the small-item vegetable case has been removed, install by positioning "FRONT" that is written on the bottom of the case on the front side.
- When washed in water, make sure you thoroughly dry off any droplets of water before replacing.

Water supply tank / Purification filter

Once a week

- ① Remove the lid clean the water supply tank with water.
- ② Turn the water purification filter to unhook and remove it.
- ③ Gently rinse the water purification filter.
- ④ Remove the packing running on the edges from the back. Clean it with water.

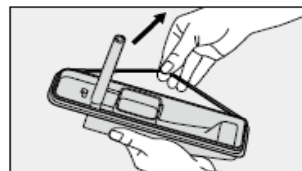
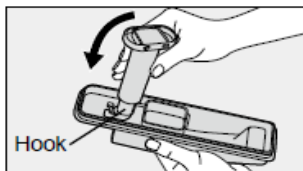
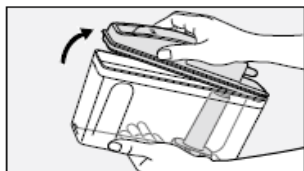

- ⑤ Fit the water purification filter and the packing.

- As a guide, replace the purification filter every three years. (separately sold parts : P.22)
- If there is water scale on the purification filter, ice may not be properly made.

Washable ice-making tray (Automatic ice-maker)

Once or twice a year

■ Remove the ice-making tray and rinse it.

- ① Set **AUTO ICE OFF** ON, stop the auto ice making function. (P. 15)
- ② While viewing from below, pull forward the blue lever to pull out the ice-making tray.
- ③ Clean it with water. Do not rub the surface with a sponge etc. (If the ice-making tray is scratched, ice may not be properly released, leading to a malfunction.)

- The ice-making tray and its frame can not be separated.
- Do not use a dishwasher-dryer.

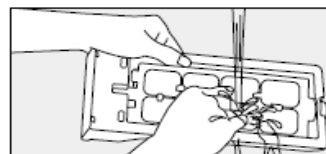

■ Installation

- ① Push in until it makes a locking sound.
 - If it is not completely installed, ice may not be made.
- ② Cancel the **AUTO ICE OFF** setting, auto ice making starts again. (P. 15) (Operate in the same way as when setting **AUTO ICE OFF** ON.)

- Ice will not be made until the **AUTO ICE OFF** setting is canceled.
- Do not directly put water in the ice-making tray after cleaning. (That may cause ice cubes sticking together or a malfunction.)

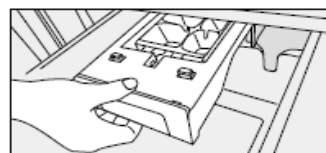

Door shelf / Bottle shelf

Once every three months

■ Remove

Tap the bottom of the small shelves upward or slide alternately the left and right of the big shelves upward, and raise them slowly.

(Tightly attached)

- Remove the free shelf before the bottle shelf.



Slide the shelves upward.

■ Re-installing

Set each shelf horizontally, with the mark [>PS<] on the right, and push it down to its proper position.

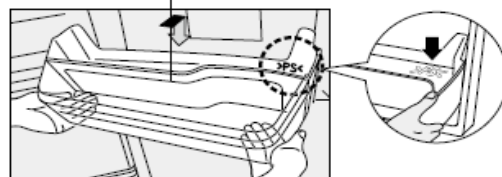

In these cases?

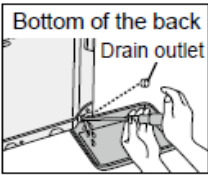
<p>The power failed.</p>	<ul style="list-style-type: none"> ● Keep the doors closed and do not store additional food. ● [QUICK FREEZING] stop. Reset these functions to use them after the power recovery.
<p>The power plug was disconnected.</p>	<ul style="list-style-type: none"> ● Wait at least 7 minutes, and then plug in the power plug. (If it is plugged in immediately, the compressor will be overloaded, which may cause a malfunction.)
<p>The refrigerator is not used for a long time.</p>	<ul style="list-style-type: none"> ● Remove all foods and drinks and clean the refrigerator. <ol style="list-style-type: none"> ① Disconnect the power plug. ② Clean the compartments and the ice-making tray. (P. 16 to P. 17) ③ Keep the doors opened for 2 to 3 days to dry the compartments. (When drying is insufficient, the compartment may get moldy or have a foul smell.)
<p>The automatic icemaker is not used for a long time. →When starting to use the automatic icemaker again, switch on the "AUTO ICE OFF" function.</p>	<ul style="list-style-type: none"> ● Stop ice making, with the water supply tank empty, and clean the icemaker. <ol style="list-style-type: none"> ① Discard water in the water supply tank. ② Stop making ice. (P. 15) ③ Discard the stored ice in the ice-making tray and the ice storage box. If ice cubes are left for long, they may become small or stick to each other. ④ Clean the upper case in the freezer compartment, the ice shovel, the water supply tank and the ice-making tray with water. Dry them well and then put them back to their position. The water purification filter in the water tank contains water. Dry it properly.
<p>When you move or transport the refrigerator.</p>	<ul style="list-style-type: none"> ● Do not transport refrigerators in a horizontal position. (Doing so cause a failure of pipes around the compressor possible to be broken.) ● Remove the food and drinks in all compartments and discard the remaining water and ice. Then, move the refrigerator with at least two people. <ol style="list-style-type: none"> ① Remove the food and drinks and discard water in the water supply tank. ② Stop the auto ice making function. (P. 15) ③ Clean the ice-making tray. (P. 17) ④ Remove the front grille screw in the adjustable legs. (Remove the front grille before transporting the refrigerator.) ⑤ Disconnect the power plug. ⑥ Drain water from the evaporating pan. <ul style="list-style-type: none"> • Put a container not exceeding 3 cm tall (with a volume of about 500 ml) under the drain outlet, and take the stopper off (at the bottom on the back). • At first, break the film inside the drain outlet to let water out. (From the next time, you only have to take the stopper off to let water out.) • After draining water, put the stopper back tightly (for prevention of water leakage). <div data-bbox="1209 1240 1417 1413" style="float: right; border: 1px solid black; padding: 5px; margin-top: 10px;">  <p>Bottom of the back Drain outlet</p> </div> <p style="text-align: center;">Attention</p> <ul style="list-style-type: none"> ● If frost remains on the cooling unit (not visible from the outside) in the refrigerator, then water may spill when it is moved. (It takes approximately 15 hours for the frost on the cooling unit to melt after the refrigerator power plug is disconnected.)
<p>When you replace the room lamp</p>	<ul style="list-style-type: none"> ● When replace room lamp, please contact with your authorized dealer or service center.

If the following sounds or indications are generated

The refrigerator compartment or freezer compartment door is open! (The "Notice" area then alternately indicates "U" and "10".)

1 minute later...Double-beep, 3 minutes later...Two double-beep, 5 minutes later...Continuous double-beeps

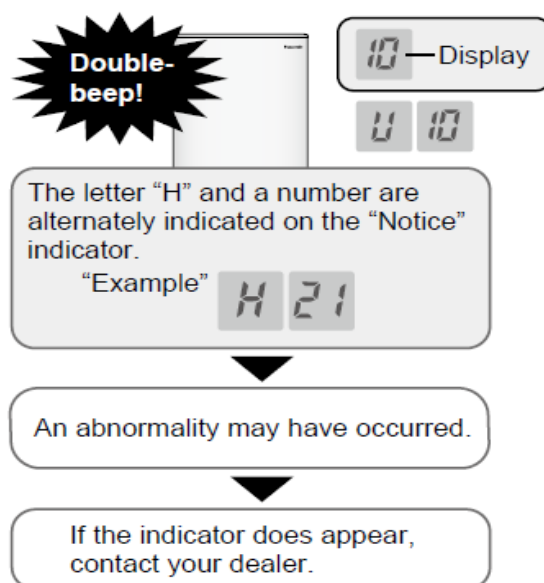

ECO NAVI Q&A

When does ECO NAVI operate?	<ul style="list-style-type: none"> ECO NAVI by itself operates depending on the brightness around the refrigerator, the change in the compartment temperatures, and the frequency of door opening and closing. (ECO NAVI lamp lights up during ECO NAVI operation.)
ECO NAVI lamp does not light (ECO NAVI does not operate)	<ul style="list-style-type: none"> ECO NAVI system operates only when the temperature of the refrigerator compartment is set as "4 °C" or "5 °C" and the temperature of the freezer compartment is set as "-19 °C", "-20 °C", or "-21 °C". If "U" or "H" is displayed on the notice indicator, ECO NAVI does not operate. ECO NAVI does not operate until the refrigerator has been sufficiently cooled. ECO NAVI does not operate if you store hot food or you frequently open and close the doors. The learning function may disable ECO NAVI operation in times of day when the doors are frequently opened and closed, in order to cool the refrigerator well. If a power failure occurs, the collected learning function data will be lost. ECO NAVI rarely operates until the learning function has collected sufficient data.
ECO NAVI lamp does not turn off.	<ul style="list-style-type: none"> If the light intensity sensor (P. 11) is hidden or scratched, the sensor may not work properly. ECO NAVI may continuously operate even when the doors are opened and closed, depending on the change in the compartment temperatures, while the cooling performance is maintained.
ECO NAVI lamp turns off when the doors are not opened and closed.	<ul style="list-style-type: none"> When (automatic) defrosting starts during ECO NAVI operation, for example, ECO NAVI is stopped in order to perform normal cooling operation after the defrosting. The learning function may switch ECO NAVI operation back to normal cooling operation.

Troubleshooting

If you feel that the refrigerator is not working properly, check out the following points first. If the trouble persists, disconnect the power plug and contact your dealer or an authorized service center.

The following sounds are not abnormal.

From inside the refrigerator

- Snapping sound
The sound of parts expanding and contracting as a result of temperature changes.
- Zooming sound
The sound of the fan operating.

From the automatic icemaker and water supply tank

- Whirring, rattling, and bubbling sounds
The sounds produced when ice is released by the automatic icemaker and water is supplied. (approx every 2 hours).

When the freezer door is opened

- Hissing sound
The sound of water being evaporated by the heater during defrosting.

From the back

- Bubbling, hissing, and flowing sounds
The sounds of refrigerant (gas) flowing.

From the bottom of the back

- Clicking sound
The sound produced when the electrical components and compressor are operating.
- Zooming sound
The sound of the compressor operating.

This section explains by using the illustration of NR-C370GH

Sound	Rattling noise	<ul style="list-style-type: none"> ● Is the floor tough and horizontal? (P. 6) ● Do both the legs reach the floor and is the refrigerator properly fixed? (P. 6) ● Do the sides of the refrigerator not touch the walls or furniture around the refrigerator? (P. 6) ● Does the power cord of the refrigerator not touch the walls or furniture around the refrigerator? (P. 6)
	Noise bothers me	<ul style="list-style-type: none"> ● The compressor or the fan may make loud noise when the refrigerator is being cooled, such as when the refrigerator is not still cooled soon after installation; the doors are frequently opened and closed; the temperature around the refrigerator is high, or quick freeze is set ON. This is not abnormal. → When the refrigerator has been cooled, the noise becomes small.
	A bubbling or clicking sound is heard when the door is closed.	<ul style="list-style-type: none"> ● Air taken into the interior is suddenly cooled. The inner pressure becomes lower than the external air momentarily. The items in the compartments seem to have been "sucked". ● When the door is closed with a force or the floor is uneven, the refrigerator shakes and generates noise. Place a plate under the refrigerator to prevent it from shaking. (P. 6)
Hot	The top of the refrigerator is hot	<ul style="list-style-type: none"> ● The mechanical section releases heat. (P. 6)
	Front (or side) panel is hot	<ul style="list-style-type: none"> ● The left and right side surfaces may become hot to let out heat generated when the refrigeration system operates. The temperature may become 50 °C to 60 °C (when the ambient temperature is 30 °C) after installation or in the summer, but this is not abnormal.
Operation	The control panel does not work.	<ul style="list-style-type: none"> ● Are you operating a control panel with the PC door opened? ● The control panel locked or not?
Door	When a door is closed, another door is opened.	<ul style="list-style-type: none"> ● Wind pressure by closing a door may open another door for an instant.
	The door is heavy when opening it immediately after closing.	<ul style="list-style-type: none"> ● Air taken into the interior is suddenly cooled. The inner pressure becomes lower than the external air momentarily. The doors seem to be pulled towards inside.

Ice making	Ice cannot be made	<ul style="list-style-type: none"> ● When you use this refrigerator for the first time, ice will be made after the interior has cooled down sufficiently. (24 hours or more may be required.) ● Is the ice making function set to "AUTO ICE OFF" ? ● Are the water supply tank (P. 14) and ice-making tray (P. 17) set correctly? ● Is there any food etc. in the ice storage box? ● Do you not frequently take in and out the ice-making tray? ● To determine if the ice maker is working, press and hold the function selection button for more than 10 seconds. If the water in the water receiver is reduced, the ice machine is running.
	Ice cubes are not frozen inside	<ul style="list-style-type: none"> ● Lower the set temperature of the freezer compartment.
	The shape of ice is not "cubic"	<ul style="list-style-type: none"> ● There are projections. <ul style="list-style-type: none"> → They are the connecting parts frozen in the ice-making tray. ● The ice cubes are round or connected to other ice cubes. <ul style="list-style-type: none"> → Isn't the ice stored for a long time? (Ice cubes get round or connected by sublimation.) ● The ice is small. <ul style="list-style-type: none"> → Small ice cubes sometimes produced when water in the tank is exhausted.
Smell	Ice smells	<ul style="list-style-type: none"> ● Do you clean the water supply tank and purification filter once a week? (P. 17) ● Is any cleaning agent, benzene, bleach used for caring? (P. 17) ● Is the water purification filter deteriorated? (P. 17) ● Have you put strong smelling foods into the other compartments?
	The interior smells	<ul style="list-style-type: none"> ● Are strong smelling foods hermetically sealed? ● Odor often attaches to the interior walls. <ul style="list-style-type: none"> → Dip a soft cloth in lukewarm water and squeeze it. Wipe it with this cloth.
Cooling	Does not get cold at all	<ul style="list-style-type: none"> ● When you use this refrigerator for the first time, from 4 to 24 hours or even more are required until the refrigerator begins to cool. ● Has the power supply failed?
	Does not get cold enough	<ul style="list-style-type: none"> ● Lower the set temperature of the refrigerator. ● Is a food item blocking the cold air outlet? (P. 7) ● Is the refrigerator subject to direct sunlight or are there any heating devices in its vicinity? (P. 6) ● Is sufficient spaces secured around the refrigerator? (P. 6) ● Is a hot item stored, doors opened frequently, or too much food stored? ● Is the front grille covered with dust? (P. 6)
	Frost and dew	<p>Freezer compartment/refrigerator compartment</p> <ul style="list-style-type: none"> ● This condition occurs when humidity is high, door was kept open for a long time, or opened frequently. ● Is a door slightly open due to a commercially available tube stand or the like being caught in it or too much food being put in the refrigerator? <p>Vegetable compartment</p> <ul style="list-style-type: none"> ● Because the humidity in the vegetable compartment has been set higher. <p>Outside of the refrigerator</p> <ul style="list-style-type: none"> ● May occur when using [QUICK FREEZING] in succession when there is high humidity. <ul style="list-style-type: none"> → Simply wipe with a piece of dry cloth.
	The food is frozen	<ul style="list-style-type: none"> ● Increase the set temperature of the refrigerator. ● Is the ambient temperature 5 °C or below? → lower the set temperature of the refrigerator. ● Did you put food with high water content near the cold air outlet in the refrigerator (P. 7) or in the chilled room?

Specifications

MODEL	NR-C370GH-N3	NR-C370GH-W3	NR-C340GH-N3	NR-C340GH-W3
TOTAL STORAGE	303 L		273 L	
STORAGE FRIDGE	204 L		174 L	
STORAGE VEGETABLE	57 L		57 L	
STORAGE FREEZER	42 L		42 L	
OUTSIDE DIMENSIONS WIDTH × DEPTH × HEIGHT	590 mm × 633 mm × 1802 mm		590 mm × 633 mm × 1682 mm	
WEIGHT	78 kg/ 172 lb		74 kg/ 163 lb	
RATED VOLTAGE RATED FREQUENCY	Indicated on the quality indication label on the inside of the refrigerator compartment door.			

This refrigerator's volume is based on IEC 62552.

Separately sold parts



Water purification filter
for water supply tank (P. 17)
CNR MJ-108850

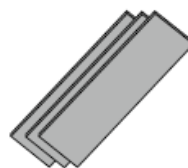

A set of adjustment plates (P. 6)
CNR 79-338120

目錄

簡介	安全須知	24
安裝	安裝	27
	選擇正確的位置	27
操作	如何檢視及操作控制面板	29
	各項功能的使用	32
	冷藏室	32
	蔬果室	34
	急凍室	34
	自動製冰機	35
附錄	清洗，取出並重新安裝	37
	清潔	37
	遇到如下情況時	39
	ECONAVI 常見問答	40
	故障排除	40
	規格	42
	另售零件	42

- 該產品主要適用於家用電器及其相關應用，例如
 - 商店、辦公室和其它工作環境的員工食堂；
 - 農舍和住有旅客的酒店、旅館以及其他居住環境；
 - 住宿加早餐經營型態的環境；
 - 餐飲和相關非零售應用。

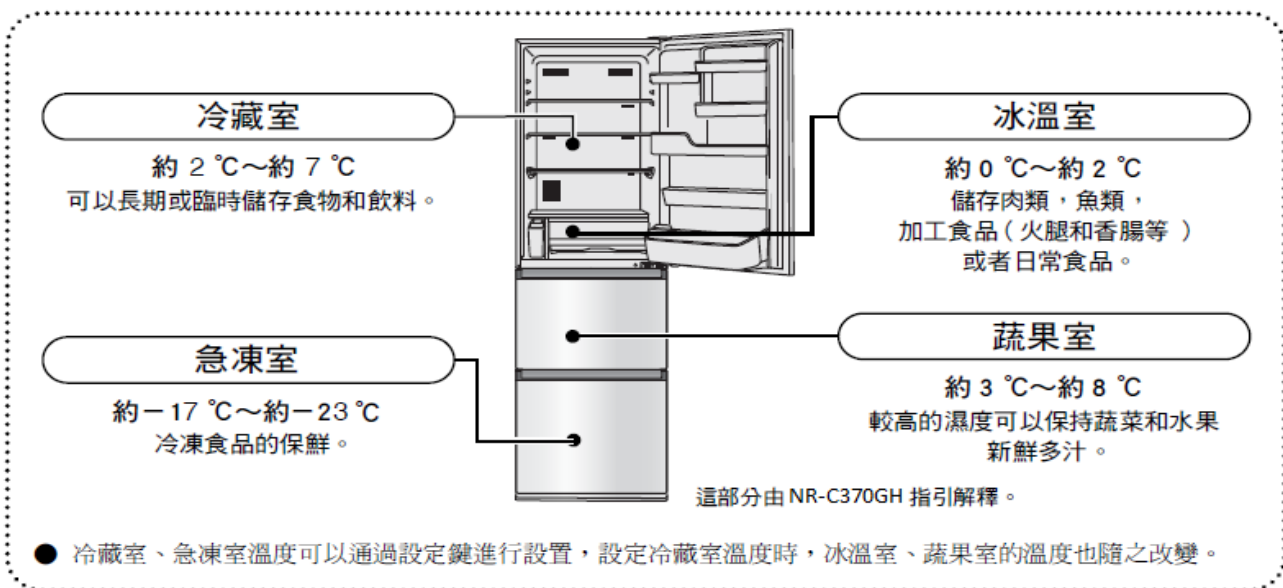

安全指引

圖標含義

 切勿	 確保執行此事項	 表示電器必須接地，以防止觸電
 切勿拆卸	 警告：可燃 / 易燃材料的風險	



警告

表示可能有導致死亡或嚴重受傷的危險。



本產品不適合下列人士（包括兒童）使用：身體官能或心智能力退化的人士，或缺乏經驗與知識的人士。他們需要有負責其安全的人員在旁監督，或指示產品的使用方法，方可使用。兒童應當予以監管，確保他們並無把玩本電器。

關於電源插頭及電源線...



- 請定期擦拭電源插頭上的灰塵。
- 把電源插頭獨立插入牆上相應電壓之插座上，並確保插頭已完全插入。
- 拔除電源插頭時，請勿使用拉扯電線的方式，應牢靠持握電源插頭後再予以拔除。
- 清洗雪櫃前請先拔掉電源插頭。
- 長時間不使用的時候，務必將電源插頭從插座拔開。
（否則可能發生火災或觸電）
- 如電源線損壞，必須聯絡製造商 / 代理商及註冊技工更換，避免發生意外。
- 警告：安放設備時，請確保電源線沒有被卡住或損壞。



- 不要用延長電線。
- 切勿以濕手插入或拔出電源插頭。
- 不得損壞電源插頭或電線。不要切斷或處理插頭或電線；不得將插頭或電線暴露於高溫下；不得過分彎折、扭曲或拉扯插頭或電線；不得在插頭或電線上放置重物；不得將插頭或電線成束排列。
→ 若需維修插頭或電線，請聯絡經銷商。
- 請勿令雪櫃背面壓抵到電源插頭。
- 請勿使用受損、或插入插座時鬆脫的電線或電源插頭。
- 警告：不要在設備後部放置多個便攜式插座或便攜式電源。

發生異常或故障時，請立即停止使用雪櫃，並拔掉電源插頭。
（否則可能引起冒煙、起火、觸電）



- 異常、故障範例
- 電源電線、插頭異常發熱
 - 電源電線上有嚴重傷痕或變形
 - 發出焦味
 - 感覺到麻麻的觸電感
- 立即與經銷商聯絡檢修事宜。

雪櫃頂部...



- 不得放置任何東西。
（否則，雪櫃震動可能會引起東西掉落。）
- 不得在頂蓋上放置任何東西。
（否則，零件可能會變形，引起觸電。）



使用雪櫃時...



- 切勿吊掛攀懸在雪櫃門上，或坐在抽屜拉門上。
- 切勿向雪櫃內外灑水，(避免電氣絕緣失效而引起火警或觸電)。
- 警告：不得損壞製冷回路。
(可燃性製冷劑可能會著火並引起爆炸。)
- 切勿觸碰製冰盒上部的機械組件。
- 取出製冰盒時，先停止製冰功能。
- 切勿於雪櫃內儲存易燃物品。
- 切勿在本設備中儲存爆炸性物品，如備有易燃壓縮氣體的噴霧罐。
- 切勿於雪櫃內儲存化學品或科學樣本。
- 在雪櫃附近，切勿使用易燃化學物品。
- 警告：切勿在本設備的食品儲藏室內使用電器，除非該類電器是由製造商推薦的類型。
(如果製冷劑洩漏，可能會因對接點火花而引起火災。)
- 警告：除生產商推薦的設備外，不得使用機械設備或其他設備加速除霜過程。



- 警告：只能加入飲用水。
- 兒童須在大人的監護下使用本雪櫃，以確保正確操作。

安裝雪櫃時...



- 警告：確保雪櫃外殼或內置結構的通風口無阻塞。(第 27 頁)



- 請確保雪櫃插頭已插入接地的電源插座。
切勿將插頭插入未接地的電源插座(三腳插頭)。



- 切勿安裝在容易濺到水的地方。
- 不要堵塞雪櫃周圍的空間。
(如製冷劑洩漏，可能會引起火災)

當棄置及回收產品時...



- 當棄置雪櫃時，應先拆掉櫃門，以防有小童擅自藏身櫃內，發生意外。
- 本雪櫃的製冷劑為可燃性氣體。以及環戊烷用於雪櫃保溫。
廢棄雪櫃時，請以妥善的方法加以丟棄。
- 在雪櫃的整個使用壽命期間，需保持上述警告標誌完好無損。
不論是要移動雪櫃的位置還是將其轉至電器回收站，須將本使用說明書轉交給將使用或處理該雪櫃的相關人員。

緊急情況...



- 請勿打開後蓋。
- 請勿拆卸、修理或改裝雪櫃。
(以免造成人身傷害、燒傷或觸電。)



- 如果發生天然氣氣體外洩之情況，切勿碰觸雪櫃，請立即開窗通風。
- 由於使用可燃性冷媒，因此當冷卻回路(配管)受損時，請先開窗通風後，再洽詢經銷商。
- 此雪櫃必須由受過訓練的技師在工場進行維修。
(否則可能發生觸電、起火、爆炸)



表示有受傷或使物品損壞的危險。

儲存食物時...



- 切勿在玻璃托架上施加較大撞擊。
(否則這些玻璃托架可能會破碎, 你可能會因此受傷。)
- 不要超出玻璃托架。
- 如果食品容器不能達到擱架底部, 請勿將其放在門架上。
(否則可能會因食物掉落而受傷)
- 不要急凍樽裝食品或飲品。
(玻璃瓶內液體經急凍後, 可能會爆開令液體濺出。)
- 請勿用潮濕的手碰觸急凍中的食物、容器(尤其是金屬製)、冰塊。
(有凍傷的危險。)
- 發出異臭、變色的食品不要食用
(進食已腐壞的食物有損健康)

開關雪櫃門時...



- 其他人在使用的時候, 不要進行開關動作。
- 手指放在拉櫃外面時不能關閉。
- 切勿把腳放於抽屜式蔬果室之下。
(否則, 可能會夾住你的腳趾)
- 請勿用力開閉雪櫃門。
(否則可能會因食物掉落而受傷)



清潔雪櫃時...



- 請小心進行玻璃托架的安裝、拆除。
(如果玻璃托架落下的話, 會有由於碰撞和破裂導致受傷的危險)



- 切勿讓手部或腳部放於雪櫃底部。
(否則可能因鐵板邊緣而受傷)

移動或搬運雪櫃時...



- 將配有可調校的雪櫃腳的雪櫃安裝在平坦堅實的地板上。
(否則, 雪櫃可能會移動或傾倒, 造成人身傷害)
- 為脆弱的地板表面鋪上防護層等。
- 當運送雪櫃時, 請使用把手並由至少兩位工作人員搬運。
(否則可能因手滑而受傷)



安裝

選擇正確的位置

1. 把雪櫃安裝於以下地方：

- 陽光不會直接照射的地方
使冷卻效能減弱的情形最小化，並防止電力的浪費。
- 通風而乾爽的地方
使腐蝕及水氣凝結的情形最小化。
- 平穩的地台上
如安置在地毯、榻榻米、氯乙烯製的地板物料上，可能會造成地板變形、變色，所以請先在雪櫃底部放置墊板。
- 請將雪櫃放置在遠離其他裝置的地方
以防止噪音干擾及電視與其他裝置的畫面顯示錯誤。
- 易於清理電源插座的地方
請定期清理灰塵。(以免因灰塵堆積導致火災發生)
- 可以確保散熱空間的場所
雪櫃背部可貼近牆壁(當牆壁出現震動聲響或變色時，請留置一定空間。)



■ 首次使用雪櫃前(第 37 頁 ~ 第 38 頁)

- 請使用濕的軟布擦拭雪櫃內部。
- 請沖洗供水器、淨水過濾器 and 製冰盒。

2. 固定雪櫃

① 拆下腳蓋。

雙手插入腳蓋兩側上的“↓”下方，將其拉出。

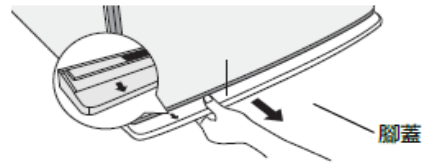

② 旋轉可調校的雪櫃腳(右和左)，使雪櫃保持平穩。

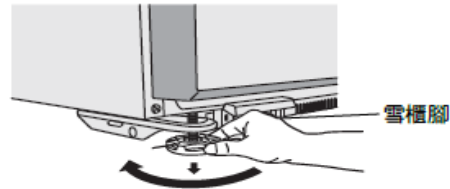

③ 重新安上腳蓋。

- 如果雪櫃安放不平穩，開 / 關雪櫃門時會出現敲擊聲。(這不會影響雪櫃的工作性能。) 請將雪櫃安裝在結實平整的地面上。

■ 雪櫃門向下傾斜

旋轉較低側的可調校的雪櫃腳以調整平穩，如右圖所示。

- 由於食品負載或地面的適應性，在安裝 4 至 5 天內雪櫃門也可能會傾斜。在這種情況下，重新調整可調校的雪櫃腳以調節平穩。
- 如果上述方法無效，採用調節墊板。
(另售零件：第 42 頁)

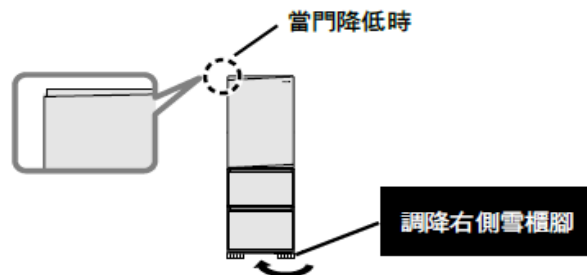

3. 插入牆上電線插座

安全地插入符合雪櫃額定電流及額定電壓的牆上電源插座。

- 設備安裝完成後，可立即將電源插頭插入插座中。
- 當電源開啟時，雪櫃周圍及表面（側面）可能會發熱（在環境溫度 30 °C 時約有 50 °C 至 60 °C），這是正常現象。（第 41 頁）
- 如果移除電源插頭，請至少等 7 分鐘後再重新接上。（第 39 頁）

4. 冷卻雪櫃內部。

- 內部冷卻大約需要 4 個小時。
- 夏天雪櫃內部均勻冷卻需要 24 個小時或更長時間。
- 雪櫃內部完全冷卻後，方可製冰。
- 雪櫃內部完全冷卻前，切勿開 / 關雪櫃門。（暖空氣流會進入內部阻礙冷卻功能。）

須知

- 切勿拆下背部封條。
這是為了密封隔熱材料的填充孔。
將其拆下會降低冷凍效果。
如果你已經拆下了它，請用剪成四方形的布包紮帶將其重新密封。

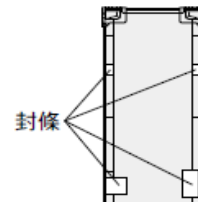

■ ECO NAVI 運作模式

ECO NAVI 燈號在 ECO NAVI 運作模式中會亮著。

ECO NAVI 只會在冷藏室溫度設定在「4°C」，「5°C」，急凍室溫度設定在「-19°C」，「-20°C」，「-21°C」的時候運作。

透過開關雪櫃門，自動學習家庭的生活模式，預測不常使用的時段，並在此時段進入 ECO NAVI 運作模式。

雪櫃在開始使用的前 3 週內，會記憶您的生活模式，第四週開始則開始採用其所學之方法。因此，ECO NAVI 之模式開啟 / 關閉指示燈可能自第 4 週起更改。

- 在雪櫃周圍環境變黑* 時會進入 ECO NAVI 運作模式，例如睡覺時。
- 燈號的亮度約在亮起約 5 分鐘後變弱。

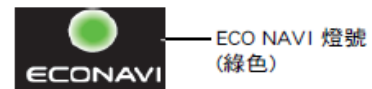

ECO NAVI 運作模式在一些使用狀況下可能無法進行。（第 40 頁）

※ 由光照強度感應器偵測黑暗，大約在 3 至 10 lux 以下。

■ 節能考慮

- 雪櫃保鮮室不應放置過多食物。
這可能會妨礙冷氣流動。食物間應保留空間。
- 盡量減少開關雪櫃門的次數。
防止經常開關形成冷氣流失的路徑，減少電氣的浪費。
- 不要讓食物阻擋冷空氣出風口。
如冷空氣不能輸送到保鮮室內所有角落，雪櫃裏就會冷度不足，從而消耗更多電力。
- 冷氣經管道由背板上的排氣口排出。
- 熱燙的食物或飲料要先冷卻後才放入雪櫃。
否則不單會令雪櫃內部升溫，更會影響其他食物的新鮮度。

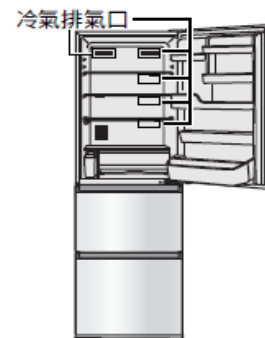

這部分由 NR-C370GH 指引解釋。

如何檢視及操作控制面板

- 通常顯示燈是熄滅的，以節省電力。
當電源開啟後，所有的功能顯示燈都會閃爍點亮4秒後，溫度顯示區迴圈閃爍顯示冷藏室、急凍室溫度，同時AG CLEAN圖示點亮。

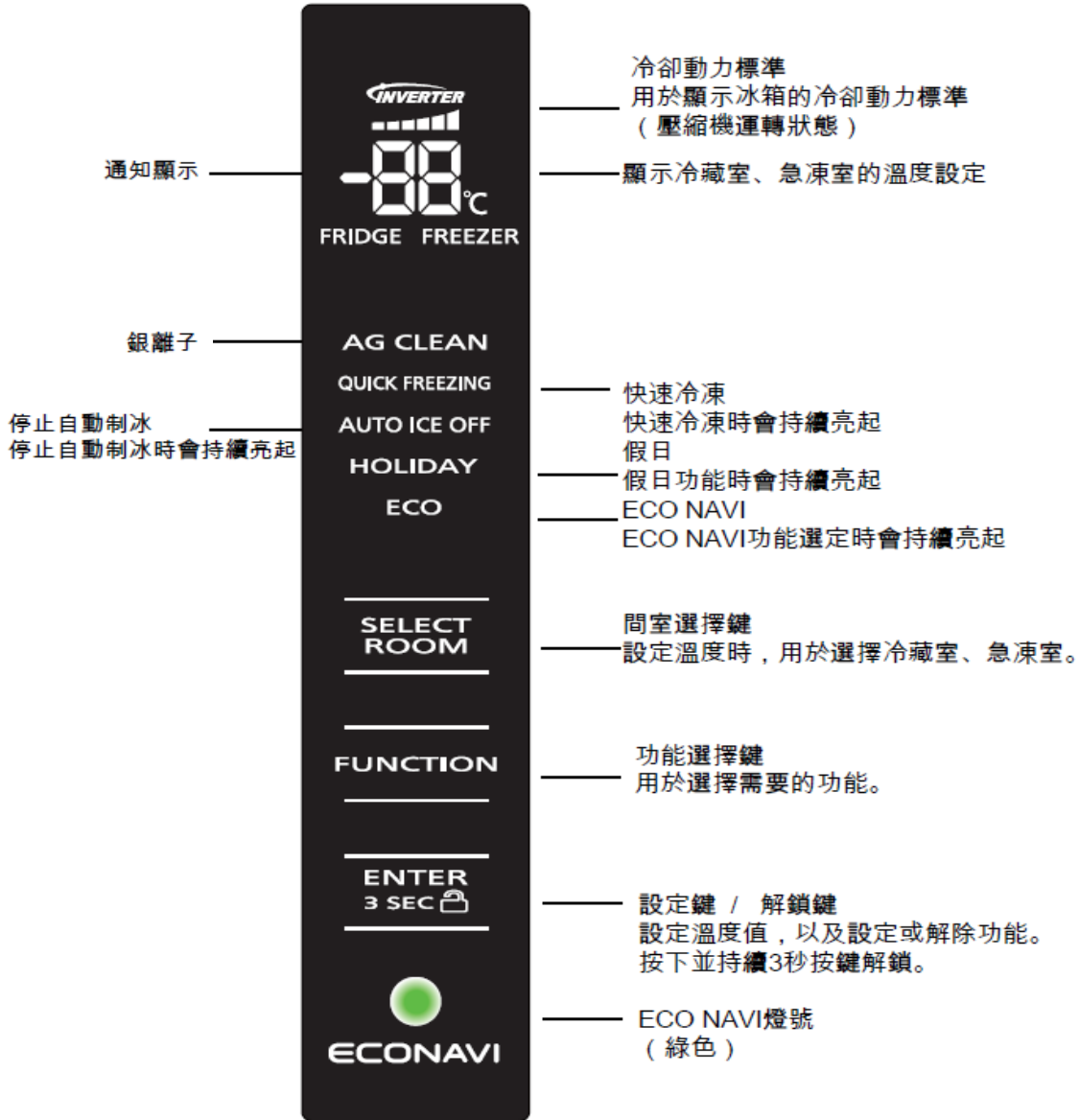

- 為了說明，所有內容皆為顯示狀態
- 唯有關閉櫃門時，才可變更設定。

■ 調節溫度

冷藏室的設定溫度範圍為7°C~2°C，急凍室的設定溫度範圍為-17°C~-23°C。
如果想要改變製冷狀態，可以調整溫度。

步驟

選擇「急凍」或「冷藏」

① 按下  並持續3秒以上，控制面板解鎖。

② 按下  ，使想要設定的間室閃爍。

更改選項至想要的設定。

③ 按下  ，設定欲更改的設定值。

顯示

【冷藏】

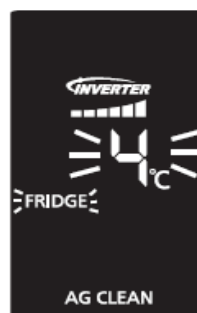

【急凍】





中文

備註

解鎖狀態下如無按鍵操作，10秒後控制面板自動鎖定。
如果控制面板熄滅了，請重新進行設定模式。

■ 設定功能

步 驟

- ① 按下 ，並持續3秒以上，控制面板解鎖。
- ② 按下 ，選擇欲設定的功能。
- ③ 按下 ，設定欲設定的功能。

顯 示

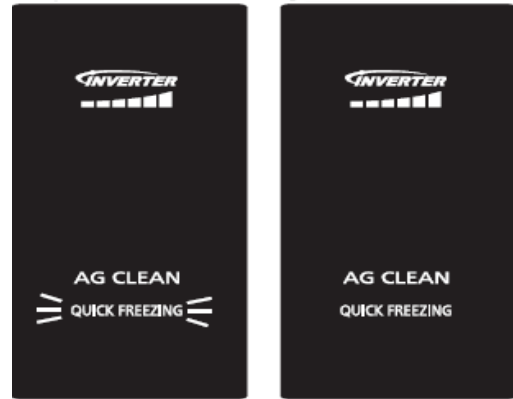

中文

備註

AG CLEAN功能無需設定，雪櫃開機後自動運行。

各項功能的使用

冷藏室

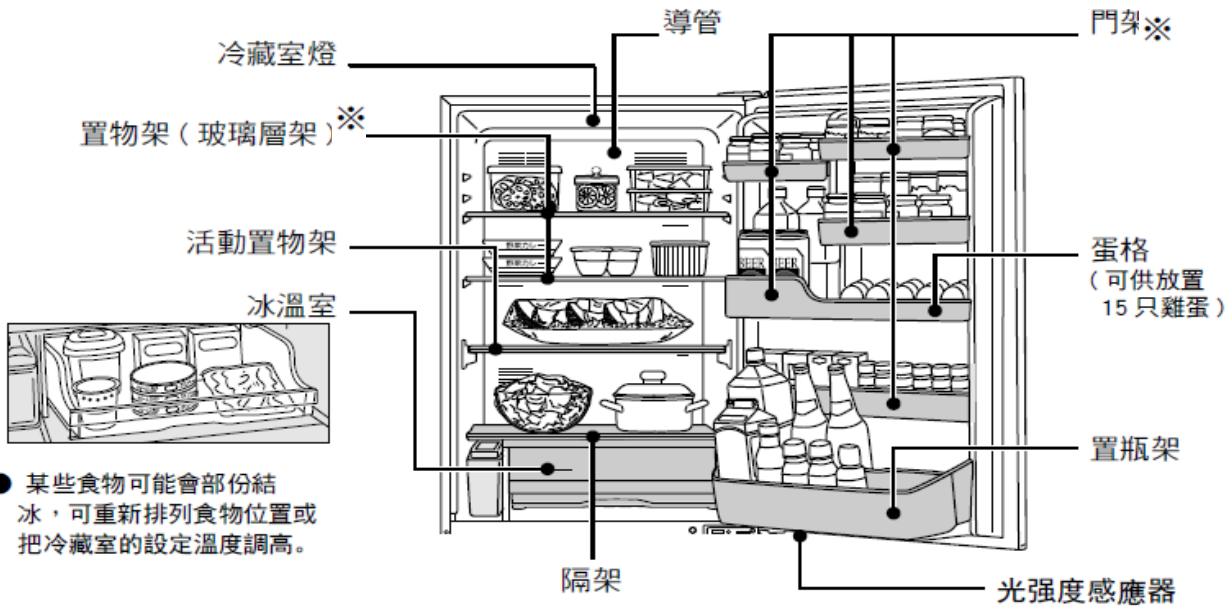

● 某些食物可能會部份結冰，可重新排列食物位置或把冷藏室的設定溫度調高。

這部分由 NR-C370GH 指引解釋。

※ NR-C340GH 有 3 個門架、1 個置物架 (玻璃層架)。

如何使用活動置物架

■ 自由調校托架可摺疊到後方。

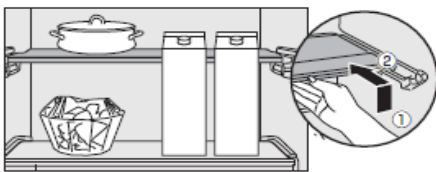

托起前面部份
然後向後推入。
你便可存放較
高物件。

■ 摺疊托架可翻到後方。

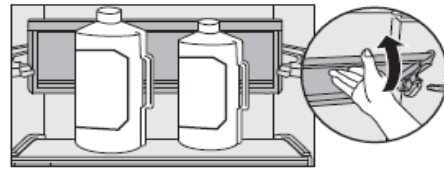

你便可存放
較大物件。

改變置物托架的高度 (玻璃層架)

■ 拆卸

托起層架後方使其
離開 (兩個) 突起
然後將層架滑出。

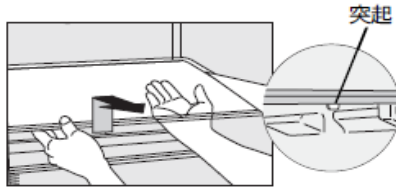

突起

■ 安裝

將層架推入後方並放在
突起上。

這些食品請先用密閉容器或保鮮膜保存！



避免雪櫃機身內部變色

● 切開後的柑桔類食物
(容易令白色塑膠物料變色)



避免氣味擴散！



● 蒜頭或其他氣味濃烈的蔬果
(氣味會擴散至其他食物)



HOLIDAY

使用假日功能

中文

- ① 按下 ，並持續3秒以上，控制面板解鎖。
- ② 按下 ，確保僅 **HOLIDAY** 閃爍。
- ③ 按下  「嗶」聲後設定完成。（**HOLIDAY** 亮燈）。

- 選定假日功能後，冷藏室內LED照明燈不亮，並且不能顯示和設定冷藏室溫度。
- 不使用冷藏室時，可使用假日功能。選定假日功能後，水果、蔬菜等常溫下不易保存的食品，請務必取出，以免發生食品變質或微變，進而污染冰箱內部。

蔬果室

為防止蔬菜和水果乾掉，請把食物封好。

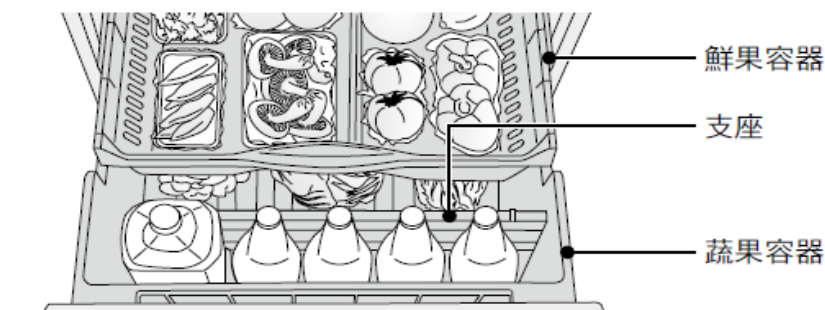

急凍室

「快速冷凍設定」可急凍吃剩的食物或飯及保持食物味道。

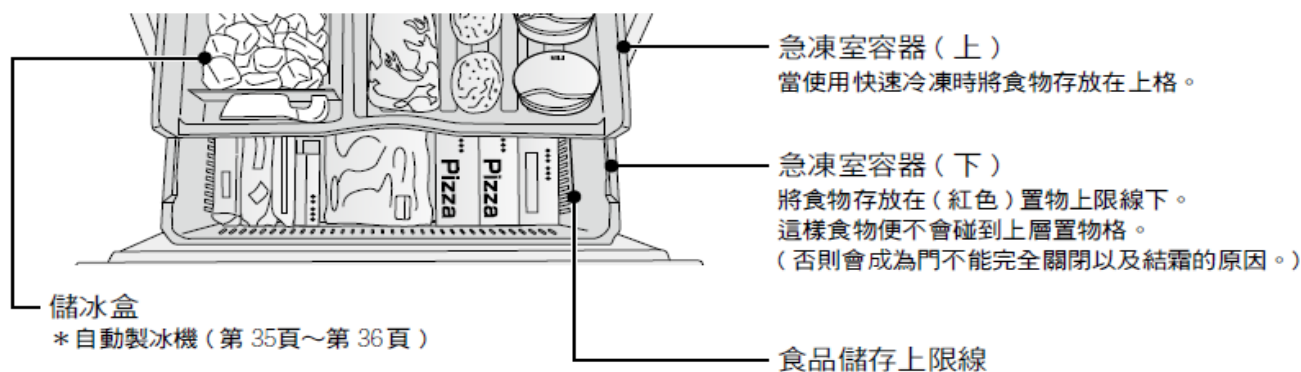





在冷凍時，三種能鎖住食物鮮味的方式

1. 快速地凍結量少且薄的食物！
2. 緊緊地包住食物！
3. 不要重新結凍！



QUICK FREEZING 使用快速冷凍（急凍室上層置物格）

- ① 按下 ，並持續3秒以上，控制面板解鎖。
- ② 按下 ，確保僅  閃爍。
- ③ 按下  「嗶」聲後設定完成。（ 亮燈）。

- 「快速冷凍設定」會在最多五十小時以後自動停止。
（當除霜時開啟快速冷凍，它會在除霜後開始並因此會延長至五十小時以上完成。）
- 在中途停止快速冷凍請重複以上①－③步驟。

自動製冰機

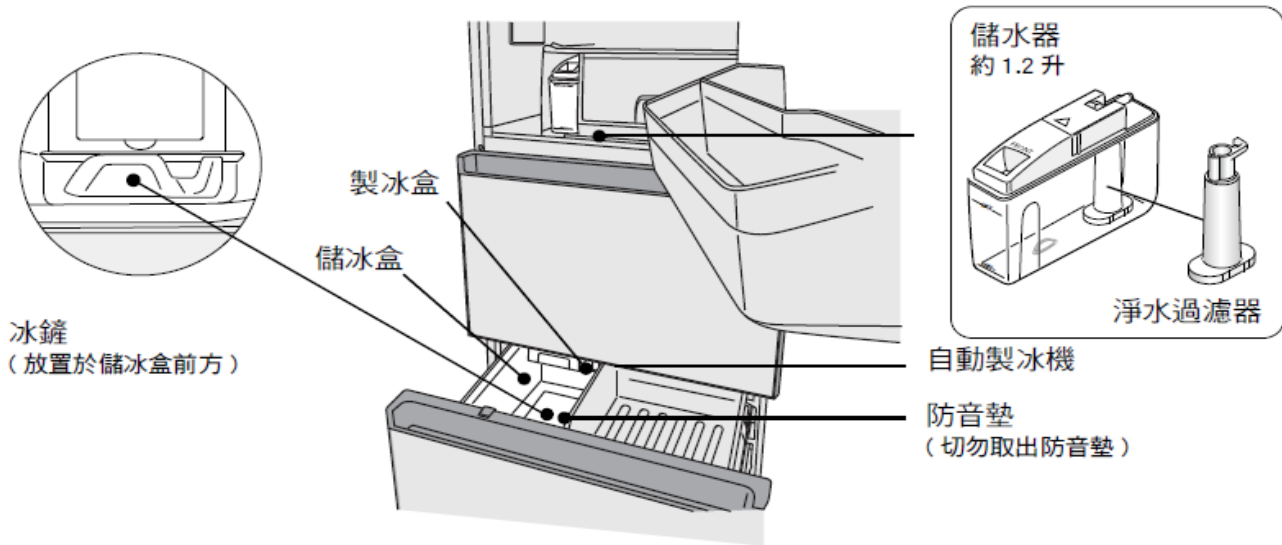

中文

舒適地使用自動製冰機

只能使用純淨水製冰。
如用自來水有可能會滋生細菌。
經常用水清潔儲水器及製冰盒。(第 38 頁)

○ 如使用下述種類的水，應經常清洗儲水器。(第 38 頁)

✗ 請勿將以下食物放入儲水器。
(採用這些飲料製冰會損壞製冰機又或會令冰塊黏在一起。)

水的硬度應為 100 mg/L 或以下。



礦泉水



果汁等飲料



運動飲料



碳酸飲料



熱水

須知

- 請勿用力開關製冰室的門 (冰塊可能會掉落到急凍室的盒子中或其他地方)
- 請勿直接注水到製冰盒製冰。(這可能會損壞製冰機或使冰塊會黏在一起。)
- 切勿直接注水進儲冰盒製冰。(否則儲冰盒有可能破裂)
- 飲用水 — 硬度 100 mg/L 以下。
礦泉水有可能會出現白色浮動粒子但無害身體。
- 切勿在製冰室放置食物或其他物件。(會有冰量無法正確檢測、停止製冰的情況)

備註

- 當第一次使用製冰室時，請丟掉第一或第二組冰塊。冰塊可能有異味或灰塵。
- 當儲冰盒放滿冰塊時，自動製冰操作會自動停止。在以下情況下，無法檢測該情況。

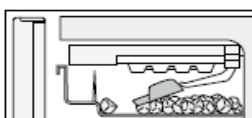

留在儲冰盒中的冰鏟撞擊到冰塊感應槓杆。

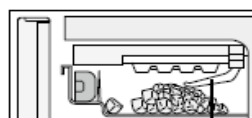

冰塊感應槓杆 (按下冰塊感應槓杆，自動製冰功能停止。)

冰塊堆積過高觸碰到冰塊感應槓杆。

製冰約需 2 個小時！

製冰

- ① 取出儲水器
如水量低於“MIN線”便需要增加水量。(請每週換一次水)

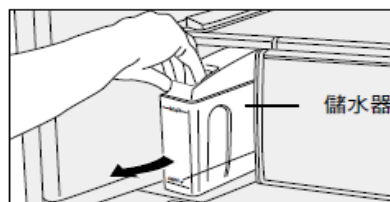

- ② 注入清水
清水注滿至“MAX線”。



- ③ 安裝儲水器
水平把持儲水器，
確認其正確方向並將其完全推入。
(如果儲水器傾斜，水有可能會灑出)





然而，以下情況將需要更長時間。

- 首次使用雪櫃。
(可能需要 24 小時或者更長時間，因為只有在雪櫃內部溫度足夠低時自動製冰功能才會啟動。)
- 經常開門。
- 門半開。
- 同時儲存大量食品。
- 冬天室溫度低或夏天室溫過高。
- 出現電源故障。
- 可洗製冰盒已經被清洗 (第 38 頁)

AUTO ICE OFF 停止自動製冰

不需要製冰時或清洗製冰盒時，請停止製冰。

- ① 按下 ，並持續3秒以上，控制面板解鎖。
- ② 按下 ，確保僅 **AUTO ICE OFF** 閃爍。
- ③ 按下  「嗶」聲後設定完成。(**AUTO ICE OFF** 亮燈)。

- 重新啟動自動製冰，重複以上①-③步驟。

須知

- 發出「嗶」聲時，請勿開啟製冰室箱門。(製冰無法停止)
- 當長時間停止使用自動製冰，請空出及清潔儲水器。(第 38 頁)

備註

- 當你中途停止使用自動製冰，冰塊會再下次啟動自動製冰時跌出。

清洗，取出並重新安裝

定期清理和維護以確保雪櫃清潔，延長雪櫃使用壽命。
清理或維護前，務必將電源插頭從插座中拔出。
切勿用濕手插拔電源插頭。否則，可能引起觸電或受傷。

清潔

使用布蘸溫水擦去易於去除的污垢。
使用蘸了廚房使用的稀釋過的中性清潔劑的布擦拭頑固污垢。
然後用蘸溫熱水的布擦去殘餘清潔劑。
為徹底清潔，請務必將雪櫃表面的殘留水分擦乾。

備註

請勿使用以下物品清潔：

- 鹼性清潔劑（這可能分解塑料配件）。
- 研磨清潔劑、肥皂粉、很燙的水或開水、刷子、酸、苯、油漆稀釋劑、酒精等（這些可能毀壞表面、塗料、塑料零件）。
- 用柔軟的濕抹布擦拭冷藏室門上的操作面板和門表面。然後用乾抹布擦乾。

置物架（玻璃層架）/ 活動置物架

每三個月一次

置物架（玻璃層架）
解開置物架後托起拉出。

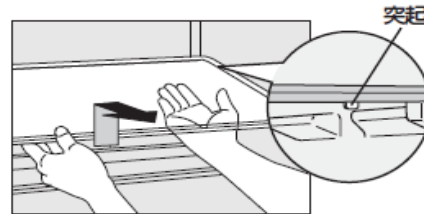

活動置物架
將托架前面部份托起後，再將托架拉出。

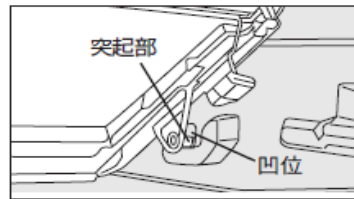

須知

- 玻璃層架有一定重量，請小心輕放以避免它們掉落，造成任何損害或傷害。

抽屜

每三個月一次

鮮果容器 / 蔬果容器 / 急凍室容器（上）

傾斜取出
將雪櫃門完全拉出後，拖高前面的部分，傾斜取出。

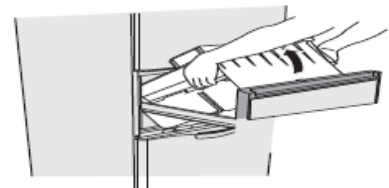

急凍室容器（下）

① 將門抬起並拉出
然後將它放在地上。

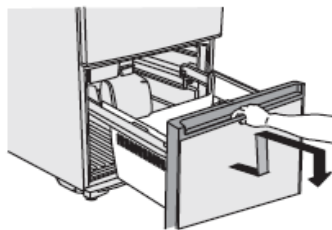

② 取出下層置物格。

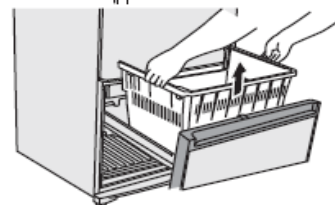

須知

- 抽屜支架的接觸面均已塗上潤滑劑，請勿抹去。
- 卸除急凍室的上層板或小型蔬果盒時，請將層板底面所標示的「此面朝前（FRONT）」字樣朝向前方，進行安裝。
- 以水清洗後，須確認已完全乾燥，無任何水滴殘留，才可重新裝入。

儲水器 / 淨水過濾器

每星期一次

- ① 拿開蓋子用水清潔儲水器。
- ② 一邊迴轉淨水過濾器，一邊拆下並拉出卡爪。
- ③ 輕輕清洗淨水過濾網。
- ④ 從蓋子的後端取出膠墊。用水清潔。

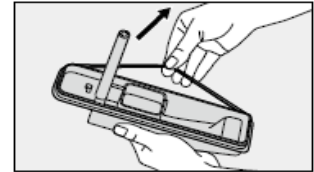
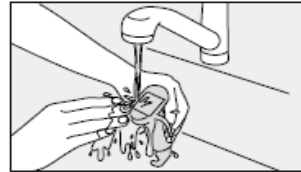
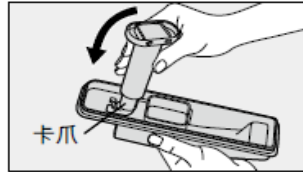

- ⑤ 裝入淨水過濾器和膠墊。
- 淨水過濾器大約每三年須更換一次。(另售零件：第 42 頁)
- 如淨水過濾器有水垢，可能無法製冰。

製冰盒 (自動製冰機可清洗)

一年一次或兩次

■ 取出，以水沖洗

- ① 開啟 **AUTO ICEOFF** 停止製冰功能。(第 36 頁)
- ② 由下探觸，將藍色拉桿往前拉出，即可卸除製冰盒。
- ③ 用水清潔。請勿用海綿等磨擦表面。
(如製冰盒有劃損，冰塊無法正常排出，會導致故障。)

- 製冰盒不能從框內取出。
- 請勿使用洗碗烘碗機清洗。

■ 安裝

- ① 推入，直到出現鎖上的聲音。
· 如沒有完整安裝，機器不會製冰。
- ② 取消 **AUTO ICEOFF** 再度開始製冰。(第 36 頁)
(當開啟 **AUTO ICEOFF**，可以同樣的方式運作。)

- 冰將不會製造直到取消 **AUTO ICEOFF**。
- 清洗後不要把水直接注入製冰盒。
(這可能會使冰塊會黏在一起或導致故障。)

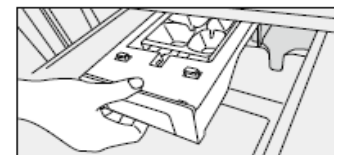
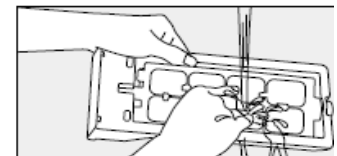

門架 / 置瓶架

每三個月一次

■ 取出

使小擱架的底部朝上或交替活動大擱架的左右兩側並緩慢抬起。(安裝得比較堅固)
· 取出置瓶架前的空間支架。

■ 重新安裝

依據右側標誌 [>PS<]，平行安裝每個支架並向下推至適當的位置。



向上滑動擱架。

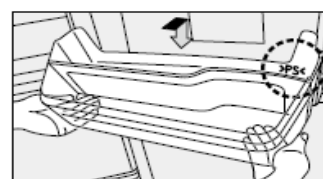

遇到如下情況時

<p>停電時</p>	<ul style="list-style-type: none"> ● 請減少開關雪櫃門，避免再將其他食品放入保存。 ● 「快速冷凍」停止。等電力恢復供應後再重新設定此功能。
<p>電源插頭被拔掉</p>	<ul style="list-style-type: none"> ● 至少要等待 7 分鐘，方可插入電源插頭。(如果立即插入電源插頭，壓縮機會超載引起故障。)
<p>長時間未使用雪櫃</p>	<ul style="list-style-type: none"> ● 取出所有食物及飲品並清理雪櫃。 <ul style="list-style-type: none"> · 拔掉電源插頭。 · 清洗雪櫃室和製冰盒。(第 37、38 頁) · 保持雪櫃門開至兩至三天，晾乾雪櫃室。(雪櫃室潮濕，可能發黴或出現臭味。)
<p>自動製冰機長時間停止使用。 → 再度使用的時候，取消“製冰停止”</p>	<ul style="list-style-type: none"> ● 停止製冰，空置儲水器，並清潔製冰機。 <ul style="list-style-type: none"> · 倒掉儲水器內的水。 · 停止製冰。(第 36 頁) · 倒掉製冰盒和儲冰盒中儲存的冰。 <ul style="list-style-type: none"> 當冰儲存時間久的話，冰塊會變圓或會粘接。 · 沖洗儲冰盒、冰鏟和儲水器。擦乾水並將它們放回原位。 積水箱中的淨水過濾器會存有水，請充份讓它乾燥。
<p>移動或搬運雪櫃</p>	<ul style="list-style-type: none"> ● 不要橫放著搬運雪櫃。(可能導致壓縮機管道破損) ● 取出雪櫃中所有食品及飲料，倒掉剩餘的水及冰塊。 搬運雪櫃必須由 2 人以上進行。 <ul style="list-style-type: none"> · 取出雪櫃中所有食品及飲料，倒掉儲水器內的水。 · 停止製冰功能。(第 36 頁) · 清洗製冰盒。(第 38 頁) · 取出腳蓋及轉高調節腳。(搬運時，請在卸除腳蓋的狀態下搬運) · 拔掉電源插頭。 · 從蒸發盤上瀝乾水份。 <ul style="list-style-type: none"> 將一個不超過三厘米高的器皿(容量大約 500 毫升)放在排水口下，並把塞子脫除(在底部後面) 首先，弄破薄膜令水由排水口排出。 (今後，你只需脫除塞子令水排出。) 排水後，將塞子緊緊放回(防止漏水)。 <div data-bbox="1193 913 1402 1088" style="float: right; margin-top: 20px;"> </div> <div data-bbox="384 1189 560 1227" style="border: 1px solid black; border-radius: 15px; padding: 2px; display: inline-block; margin-top: 10px;"> <p>注意</p> </div> <ul style="list-style-type: none"> ● 如果在雪櫃內部的冷卻器(由外部看不見)殘留未溶化的霜，移動、搬運時會有灑出地板的情況。 (由拔除電源插頭到冷卻器的霜溶化為止，約需 15 小時。)
<p>當你換雪櫃內的燈膽</p>	<ul style="list-style-type: none"> ● 當更換冷藏室燈時，請與指定代理商或維修公司聯絡。

如雪櫃發出以下聲響或作出以下顯示

冷藏室、急凍室的櫃門打開了!
(在通知顯示區交替顯示“U”及“10”。)

1 分鐘後：嗶—嗶—，3 分鐘後：嗶—嗶— — 嗶—嗶—
5 分鐘後：連續嗶—嗶—聲響

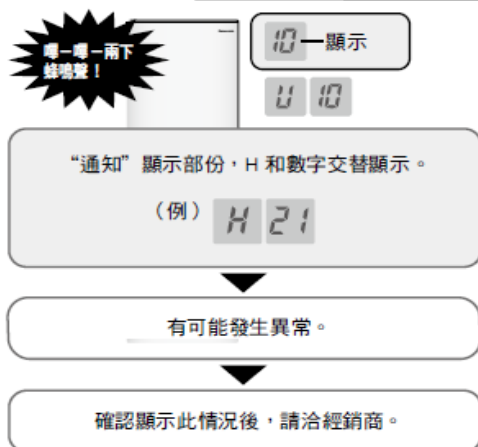

ECO NAVI 常見問答

ECO NAVI 何時運作？	<ul style="list-style-type: none"> ● ECO NAVI 本身的運作是根據雪櫃周邊的亮度，櫃內的溫度變化和門開關的次數。 (當 ECO NAVI 運作時 ECO NAVI 燈會亮起。)
ECO NAVI 燈號不亮 (ECO NAVI 沒有運作)	<ul style="list-style-type: none"> ● ECO NAVI 只會在冷藏室溫度設定在「4°C」、「5°C」、急凍室溫度設定在「-19°C」、「-20°C」、「-21°C」的時候運作。 ● 如“U”或“H”顯示在通知指示器，ECO NAVI 不會運作。 ● ECO NAVI 不會運作直至雪櫃會充分冷凍。 ● 如你儲藏熱食物或門經常開關，ECO NAVI 將不會運作。 ● 當門經常開關時，學習功能有時會關閉 ECO NAVI 運作，使雪櫃順利製冷。 ● 當停電時，所收集的學習功能數據將會遺失。ECO NAVI 會很少運作直到學習功能已收集足夠數據。
ECO NAVI 燈 不會熄掉	<ul style="list-style-type: none"> ● 如果光強度感應器（第 32 頁）被隱藏，或有劃傷，感應器可能無法正常工作。 ● 根據櫃內的溫度變化，即使門被打開和關閉，ECONAVI 可持續運作。但不會影響製冷效能。
ECO NAVI 燈會熄掉 當門沒有被打開或 關閉時	<ul style="list-style-type: none"> ● 當（自動）除霜在 ECO NAVI 運行中啟動時。例如，ECO NAVI 會停止以便除霜後執正常的製冷運作。 ● 學習功能可能開啟 ECO NAVI 切換回正常的冷卻運作。

故障排除

如果雪櫃不能正常工作，請首先檢查以下幾點。

如果故障仍然存在，請斷開電源插頭，並與經銷商或授權服務中心聯繫。

以下的聲音是正常的。

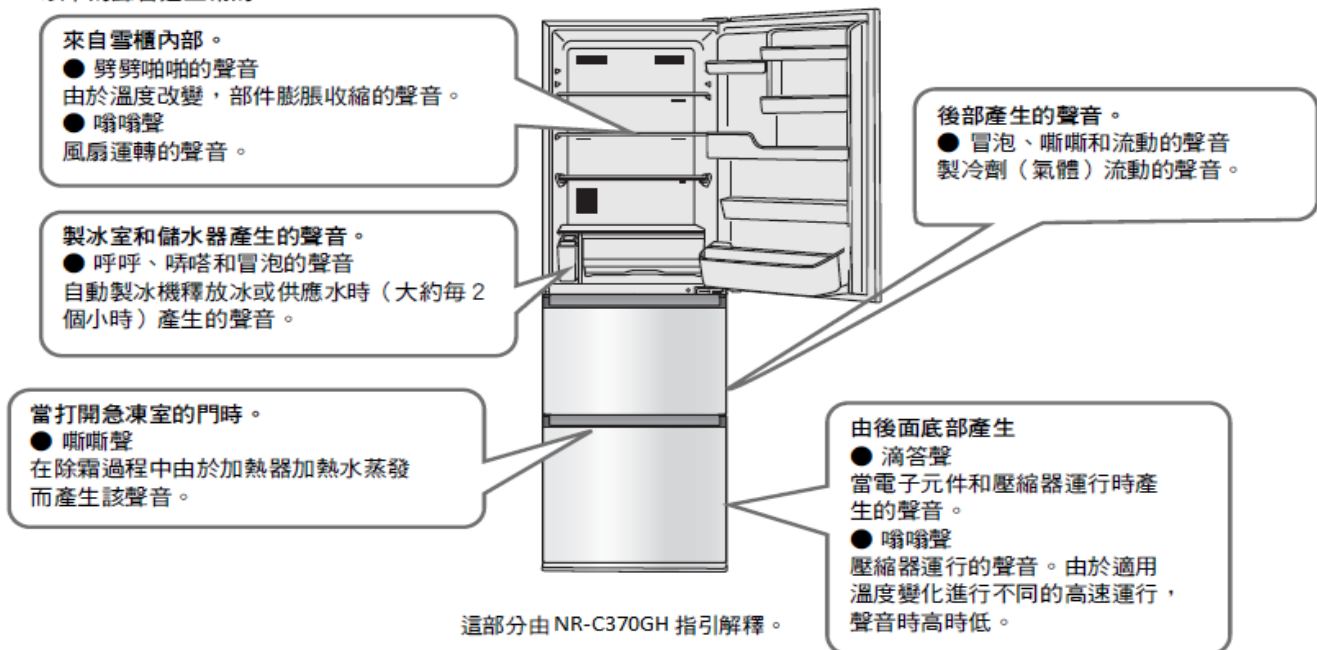

故障排除

聲音	巨大聲音	<ul style="list-style-type: none"> ● 地面結實平穩嗎？(第 27 頁) ● 雪櫃側面是否碰到牆身或傢俱？(第 27 頁) ● 雪櫃櫃腳是否觸地和妥善固定？(第 27 頁) ● 雪櫃電線是否碰到牆身或傢俱？(第 27 頁)
	有噪音	<ul style="list-style-type: none"> ● 當雪櫃製冷時，壓縮機或風扇可能會製造嘈音。比如雪櫃剛安裝，還沒有冷卻過；頻繁開關雪櫃門；雪櫃周圍的溫度過高或快速冷凍設置為開啟狀態。這是正常現象。→ 雪櫃冷卻後，噪音變小。
	關上雪櫃門時發出“撲撲”或“喀喀”的聲音	<ul style="list-style-type: none"> ● 進入雪櫃內部的空氣突然冷卻，內在氣壓暫時性地較外在氣壓低，造成如吸吮般效果。 ● 過度用力關門或地板不平穩，雪櫃便會因震動而發出噪音。在雪櫃底部放置板塊以防止震動。(第 27 頁)
發熱	雪櫃頂部發熱	<ul style="list-style-type: none"> ● 雪櫃的內部機械結構會發熱。(第 27 頁)
	表面(側面)發熱	<ul style="list-style-type: none"> ● 左、右側面可能會變熱，以散發雪櫃系統運作時所產生的熱量。在安裝後或夏天時，溫度可能會達到 50 °C 至 60 °C (當環境溫度為 30 °C 時)，這是正常現象。
操作	控制板不能操作	<ul style="list-style-type: none"> ● 是否是在 P C 門開着時操作。 ● 控制面板是否鎖定？
門	當一隻門關上，另一隻門打開	<ul style="list-style-type: none"> ● 關門的風壓可能令另一隻門即時打開。
	關閉後立即打開，門很重	<ul style="list-style-type: none"> ● 進入雪櫃內的空氣急劇冷卻。內部壓力瞬間低於外部氣壓。門似乎朝裡面拉。
製冰	不能製冰	<ul style="list-style-type: none"> ● 當首次使用該雪櫃時，要等到內部充分冷卻後方可製冰。(可能需要 24 個小時或更長時間。) ● 製冰功能設置為 [AUTO ICE OFF] 模式了嗎？ ● 儲水器(第 35 頁)和製冰盒(第 38 頁)設置正確嗎？ ● 儲冰盒中有一些其他的食物嗎？ ● 製冰盒頻繁取出嗎？ ● 去確定製冰器是否運作，長按功能選擇 FUNCTION 10 秒以上，如果儲水器中的水減少，說明製冰機在運轉。(如果水灑到儲存盒中，請擦拭乾淨。)
	冰塊內部未凍結	<ul style="list-style-type: none"> ● 調低急凍室的設定溫度。
	冰粒並非呈方塊狀	<ul style="list-style-type: none"> ● 冰塊有突出物 → 是冰塊在製冰室凝結時黏在一起所形成。 ● 冰塊變圓或與其他冰塊黏在一起 → 冰塊是否已儲存了很久？(由於升華作用冰塊會變圓或黏在一起。) ● 冰塊變小 → 冰塊變小有時是因為儲水器內缺水。
氣味	冰塊有異味	<ul style="list-style-type: none"> ● 有否每星期清洗儲水器和淨水過濾器？(第 38 頁) ● 淨水過濾器是否變舊？(第 38 頁) ● 有否使用清潔劑、揮發油或漂白劑？(第 38 頁) ● 其他的雪櫃內是否儲存了氣味強烈的食物？
	雪櫃內有異味	<ul style="list-style-type: none"> ● 具強烈氣味的食物是否已密封存放？ ● 異味常會附著在雪櫃內壁。→ 使用浸了溫水的軟布擠乾擦拭。
	雪櫃完全不冷	<ul style="list-style-type: none"> ● 當首次使用該雪櫃時，可能需要 4 至 24 個小時甚至更長時間雪櫃才開始冷卻。 ● 電源出現故障了嗎？
冷藏	雪櫃冷度不夠	<ul style="list-style-type: none"> ● 調低雪櫃的設定溫度。 ● 是否因食品等而堵塞了冷氣出風口？(第 28 頁) ● 雪櫃是否被陽光直接照射，又或是附近有發熱器具？(第 27 頁) ● 雪櫃附近是否有足夠散熱空間？(第 27 頁) ● 是否放入熱食品、櫃門經常開啟又或是放置了太多食品？ ● 前柵格是否覆蓋灰塵？(第 27 頁)
	結霜及水分凝結	<p>急凍室 / 冷藏室</p> <ul style="list-style-type: none"> ● 發生此情況是由於濕度過高，櫃門長時間打開或頻密開關。 ● 是否因市售的管架或類似的東西卡在其中，或雪櫃內放了太多食物，而造成門無法密合？ <p>蔬果室</p> <ul style="list-style-type: none"> ● 蔬果室的濕度設定過高。 <p>雪櫃機身</p> <ul style="list-style-type: none"> ● 濕度高時，連續使用「快速冷凍」效能後，有時將會造成結露或冰份凝結。→ 以乾布抹掉水氣。
	食品結凍	<ul style="list-style-type: none"> ● 調高雪櫃的設定溫度。) ● 環境溫度是否 5 °C 或以下 → 調低雪櫃的設定溫度。 ● 是否將水分多的食物，放在雪櫃內的冷氣吹出部(第 28 頁)或冰溫室？

規格

型號	NR-C370GH-N3	NR-C370GH-W3	NR-C340GH-N3	NR-C340GH-W3
總儲存量	303 L		273 L	
冷藏室儲存量	204 L		174 L	
蔬果室儲存量	57 L		57 L	
急凍室儲存量	42 L		42 L	
外形尺寸 寬度×深度×高度	590 mm×633 mm×1802 mm		590 mm×633 mm×1682 mm	
重量	78 kg/ 172 lb		74 kg/ 163 lb	
定額電壓 定額頻率	表示在冷藏室門內側的品質表示標籤。			

另售零件



儲水器用
淨水過濾器
(第 38 頁)
CNR MJ-108850

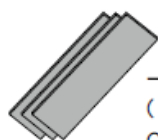

一套調節墊板
(第 27 頁)
CNR 79-338120

Panasonic Corporation

Web site: <http://panasonic.net>
© Panasonic Corporation 2018

Y1118-0
ARAK0A206180
Printed in China