

Panasonic

Operating Instructions (Household use) Rechargeable Shaver

Model No. ES-PV6A

English..... 3

中文 23

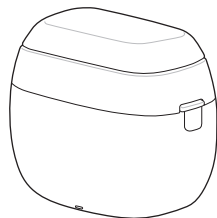

Operating Instructions
(Household use) Rechargeable Shaver
Model No. ES-PV6A

Contents

Safety precautions.....	4	Replacing the system outer foil and the inner blades	16
Important information	9	Troubleshooting	17
Parts identification	10	Battery life	20
Charging the shaver.....	11	Removing the built-in rechargeable battery	20
How to use	12	Specifications	21
Cleaning the shaver	15		

Thank you for purchasing this Panasonic product.

Before operating this unit, please read these instructions completely and save them for future use.

The USB power adaptor is sold separately.

Safety precautions

Make sure to follow these instructions.

To prevent accidents, injuries or damage to property, please follow the instructions below.

- **The following chart indicates the degree of damage caused by improper operation.**



DANGER

Indicates a potential hazard that will result in serious injury or death.



WARNING

Indicates a potential hazard that could result in serious injury or death.



CAUTION

Indicates a potential hazard that could result in minor injury or property damage.

- **The symbols are classified and explained as follows.**



This symbol indicates prohibition.



This symbol indicates requirement that must be followed.



WARNING

- ▶ **This product**

This product has a built-in rechargeable battery. Do not throw into fire, apply heat, or charge, use, leave, or store in a high temperature environment.



- Doing so may cause overheating, ignition, or explosion.

Do not modify or repair.



- Doing so may cause fire, electric shock, or injury.

Contact an authorized service center for repair (replacement of battery etc).



Never disassemble except when disposing of the product.

- Doing so may cause fire, electric shock, or injury.

- ▶ **Power supply**

Do not use in a way that would exceed the rating of the household outlet or the wiring.



- Exceeding the rating by connecting too many plugs to one household outlet may cause fire due to overheating.



Fully insert the power plug of USB power adaptor.

- Failure to do so may cause fire or electric shock.

 **WARNING**

Disconnect the USB plug when cleaning the main body with water.

- Failure to do so may cause electric shock or injury.

▶ **USB power adaptor/USB cable**

Do not immerse them in water or wash with water.

Do not place them over or near water filled sink or bathtub.



Never use them if they are damaged or if the power plug fits loosely in a household outlet. Do not damage them.

• **Do not deface, modify, forcefully bend or pull them. Also, do not place anything heavy on, twist or pinch them.**

- Doing so may cause electric shock or fire due to a short circuit.

Do not use them to charge other devices.

[Note that USB power adaptor (ES-RU1-02) can be used with compatible Panasonic products.]



- Doing so may cause burn or fire due to a short circuit.



Do not connect or disconnect them to a household outlet with a wet hand.

- Doing so may cause electric shock or injury.



Always plug the USB cable to a power supply with a rated voltage of 5.0 V and a rated output current of 1.0 A which meets requirements of the Safety Extra Low Voltage (SELV) system.

- Failure to do so may cause burn or fire due to a short circuit.



Use the specified USB power adaptor and USB cable.

- Failure to do so may cause burns, electric shock or fire due to a short circuit.



Regularly clean them to prevent dust from accumulating.

- Failure to do so may cause fire due to insulation failure caused by humidity. Remove the USB power adaptor and wipe it with a dry cloth.

WARNING

- ▶ **In case of an abnormality or malfunction**
Immediately stop using and remove the USB power adaptor.
- Failure to do so may cause fire, electric shock, or injury.
- <Abnormality or malfunction cases>
- **The main unit, USB power adaptor or USB cable is deformed or abnormally hot.**
 - **The main unit, USB power adaptor or USB cable smells of burning.**
 - **There is an abnormal sound during use or charging of the main unit.**
 - Immediately request inspection or repair at an authorized service center.

▶ **Preventing accidents**



Persons using an implanted medical electronic device, such as a pacemaker, should not allow this product to be in the vicinity of where the medical electronic device is implanted.

- Doing so may cause an accident or illness.



Do not place within reach of children or infants. Do not let them use it.

- Putting parts or accessories in the mouth may cause an accident or injury.

If oil is consumed accidentally, do not induce vomiting, drink a large amount of water and contact a physician.



If oil comes into contact with eyes, wash immediately and thoroughly with running water and contact a physician.

- Failure to follow these instructions may result in physical problems.

- ▶ **Take care of the following precautions as well**
- This appliance is not intended for use by persons (including children) with reduced physical, sensory or mental capabilities, or lack of experience and knowledge, unless they have been given supervision or instruction concerning use of the appliance by a person responsible for their safety. Children should be supervised to ensure that they do not play with the appliance.**
- Failure to do so may cause an accident or injury.



CAUTION

► Protecting the skin

Do not forcefully press the system outer foil. Also, do not touch the system outer foil with fingers or nails when in use.



Do not use this product for hair on head or any other part of the body.

- Doing so may cause injury to skin or reduce the life of the system outer foil.

Do not use excessive pressure to apply the system outer foil to your lip or other part of your face.



Do not apply the system outer foil directly to blemishes or injured skin.

Do not touch the blade section (metallic section) of the inner blade.

- Doing so may cause injury to skin or hand.



Check the system outer foil for cracks or deformations before use.

- Failure to do so may cause injury to the skin.

► Note the following precautions

Do not allow metal objects or trash to adhere to power plug of USB power adaptor or USB plug.



- Doing so may cause electric shock or fire due to a short circuit.



Do not charge when the appliance socket is wet.

- Doing so may cause electric shock or fire.



Do not share your shaver with your family or other people.

- Doing so may result in infection or inflammation.



Disconnect the USB power adaptor from the household outlet when not charging.

- Failure to do so may cause electric shock or fire due to electrical leakage resulting from insulation deterioration.

Handling of the removed battery when disposing

DANGER

- The rechargeable battery is exclusively for use with this appliance. Do not use the battery with other products.
- Do not charge the battery after it has been removed from the product.
- Do not throw into fire or apply heat.
- Do not hit, disassemble, modify, or puncture with a nail.
- Do not let the positive and negative terminals of the battery get in contact with each other through metallic objects.
- Do not carry or store the battery together with metallic jewellery such as necklaces and hairpins.
- Do not use or leave the battery where it will be exposed to high temperatures, such as under direct sunlight or near other sources of heat.
- **Never peel off the tube.**
- Doing so may cause overheating, ignition, or explosion.



WARNING

After removing the rechargeable battery, do not keep it within reach of children and infants.



- The battery will harm the body if accidentally swallowed.

If this happens, consult a physician immediately.

If the battery fluid leaks out and comes in contact with the eyes, do not rub the eyes, and thoroughly rinse with clean water, such as tap water.



- Failure to do so may cause eye injury.

Consult a physician immediately.

CAUTION

If the battery fluid leaks out and comes in contact with the skin or clothes, rinse off with clean water, such as tap water.



- Failure to do so may cause inflammation.

Important information

- This WET/DRY shaver can be used for wet shaving using shaving lather or for dry shaving. You can use this watertight shaver in the shower and clean with water. The following symbol means suitable for use in a bath or shower.



- Treat yourself to wet lather shaves for at least three weeks and notice the difference. Your Panasonic WET/DRY shaver requires a little time to get used to because your skin and beard need about a month to adjust to any new shaving method.
- Keep both the inner blades inserted. If only one of the inner blades is inserted, the shaver may be damaged.
- If you clean the shaver with water, do not use salt water or hot water. Do not soak the shaver in water for a long period of time.
- Charge the appliance correctly according to these Operating Instructions. (See page 11 "Charging the shaver".)
- This appliance contains battery that is only replaceable by skilled persons. Please contact an authorized service center for the details of repair.

Note the following precautions in order to prevent malfunction, deformation and deterioration

- Do not drop or hit against other objects.
- Do not bring the system outer foil into contact with hard objects.
- Do not leave the shaver exposed to direct sunlight with the foil frame detached.
- Do not dry using heat from a dryer or other appliance.
- Be sure to place the protective cap on the shaver when carrying around or storing.
- Store the shaver in a place with low humidity after use.

This symbol on the product means that not generated higher voltage than the safety extra low voltage (SELV). In which protection against electric shock relies on power supply.



Parts identification

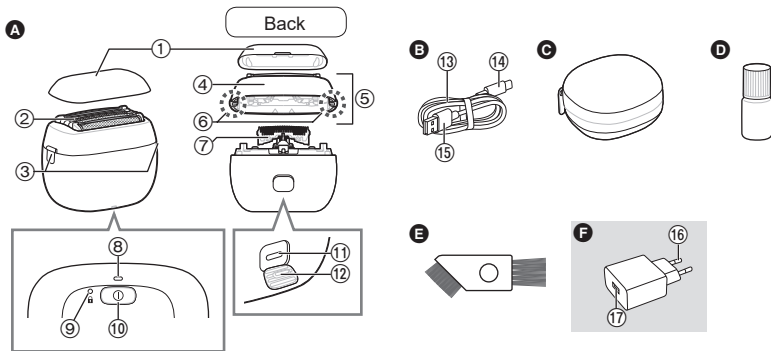

A Main body

- ① Protective cap
- ② System outer foil
- ③ Foil frame release buttons
- ④ Foil frame
- ⑤ Outer foil section
- ⑥ System outer foil release buttons
- ⑦ Inner blades
- ⑧ Charge status lamp
- ⑨ Switch lock lamp ()
- ⑩ Power switch

- ⑪ Appliance socket (Type-C)
- ⑫ Socket cover

B USB cable

- ⑬ Cord
- ⑭ USB plug (Type-C)
- ⑮ USB plug (Type-A)

Accessories

C Travel case

D Oil

E Cleaning brush

F USB power adaptor

(ES-RU1-02) (Sold separately)

- ⑯ Power plug
- ⑰ USB port (Type-A)

Charging the shaver

- Turn the shaver off.
- Wipe off any water droplets on the appliance socket.
- Use the specified USB power adaptor and USB cable.
- The USB power adaptor is sold separately.

1 Open the socket cover and insert the USB plug firmly into the main body and USB power adaptor.

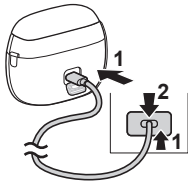

2 Insert the USB power adaptor firmly into a household outlet.

- Check that the charge status lamp is glowing.
- Charging is completed after approx. 2 hours.

3 Remove the USB power adaptor from the household outlet, and remove the USB plug from the main body after the charge status lamp turns off.

- Close the socket cover.

Note

You cannot operate the shaver while charging.

► When the battery capacity is low

- The appliance beeps twice after switched off.
 - The charge status lamp blinks once every second when operating the shaver.
- You can shave 2 to 3 times after the charge status lamp blinks. (This will differ depending on usage.)



► Notes

- The shaver may be charged with adaptors and cables other than the specified ones, but Panasonic's specified adaptor with splash-resistant design and a USB cable with an overheating protection feature should be used to ensure safety. The adaptor is not completely waterproof, so prevent it from getting wet.
- After charging is completed, turning the power switch ON with the shaver plugged in will cause the charge status lamp to light up and then turn off after 5 seconds.
- If there is noise from the radio or other sources while using or charging the appliance, move to a different location to use the appliance.
- The battery will become deteriorated even when it has not been in use for a long period of time (6 months or more), so charge it fully once every 6 months.

- When charging the shaver for the first time or when it has not been in use for more than 6 months, the charging time may change or the charge status lamp may not glow for a few minutes. It will eventually glow if kept connected.
- Recommended ambient temperature for charging is 10 °C – 35 °C. It may take longer to charge or the battery may fail to charge properly in extremely high or low temperatures.
The charge status lamp will blink twice every second when there is a problem with charging.
Charge the shaver within the recommended ambient temperature range.
- The shaver can be used for approximately 2 weeks with a full charge. (Based on one 3-minute dry-shave usages per day in an ambient temperature range of 20 °C – 30 °C.)
The number of usable days varies depending on the following conditions.
 - Beard thickness
 - Pressure applied to the skin
 - Usage in shaving foam mode
 - Usage of wet shaving
- Charging each time does not affect battery life, because it uses a lithium-ion battery.
- To keep charging the battery will not affect battery performance.

How to use

► Usable facial cleansers, etc.

		Shaving	Shaving foam mode
Shaving agent	Shaving foam	✓	—
	Shaving gel	✓	✗
	Shaving cream	✗	✗
Facial cleanser	Facial cleansing foam (without scrubbing compounds)	✓	✓
	Facial cleansing foam (with scrubbing compounds)	✗	✗
	Facial soap	✓	✗
Body soap etc.	Liquid	✓	✓
	Foam	✓	—

- Do not use anything other than above listed shaving agent/facial cleanser/body soap etc. as these may cause the blades to clog, or be unable to make foam.

Making foam in shaving foam mode

It is easier to make foam this way than by hand.

- Check the system outer foil for cracks or deformations before use.
- Check that the socket cover is closed.

1 Preparing foam

Scoop a suitable amount of facial cleanser or similar in your hand, and add a suitable amount of cold or warm water.

2 Hold for 2 seconds or more to switch to shaving foam mode.

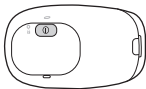

The switch lock lamp () and charge status lamp blink alternately.



- The shaving foam mode ends after 15 seconds. The shaver can then be used to shave.
- To stop using the shaving foam mode and start shaving, press the power switch once.

3 Press the blades gently in the palm of your hand, mix the facial cleanser etc. around and move the blades up and down to make foam.

- If there is insufficient foam, add slightly more water, hot water or facial cleanser etc. to make it easier to create foam.

► Notes

- Do not use shaving agent (excluding foam), facial cleansing foam (with scrubbing compounds) or soap as these may cause the blades to clog, or be unable to make foam.



Shaving beard

1 Press and shave.



The “shaving sensor”, which automatically adjusts the power depending on the beard thickness, will operate. It will shave with high power on areas where the beard is heavy, and reduce the power on areas where the beard is thin, to reduce burden on the skin.

Tips for better shaving

Apply the whole system outer foil perpendicularly against the skin and shave by slowly gliding the shaver over the face against the grain of the beard.

- The beard under the chin and around the throat can be shaved better by stretching the skin so the beard will stand.
- To prevent damaging the system outer foil, do not shave with only a part of the system outer foil.

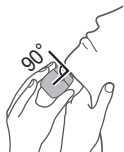





2 Press when finished.

► Notes

- The appliance may not operate in an ambient temperature lower than approximately 5 °C.
- The shaving sensor may not respond depending on the type and quantity of the shaving gel or the quantity of the foam. This is not abnormal.
- After wet shaving, wash the main body with water and apply oil to the system outer foil.



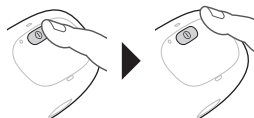

Operation and display of the switch lock

► Locking the power switch

1. Press  once and then release.
 - The shaver starts operating.
2. Hold  for more than 2 seconds until the switch lock lamp () turns on.
 - The shaver will stop operating.
3. Release .
 - The switch lock lamp () will turn off after 5 seconds.



► Unlocking the power switch

- Hold  for more than 2 seconds until the switch lock lamp () turns off.
 - The switch lock lamp () will turn off.
 - The shaver starts operating.
- Release .

The power switch is locked when the switch lock lamp () blinks for 5 seconds and the shaver does not operate even though the power switch is pressed.





Cleaning the shaver

- We recommend cleaning the shaver after each use.
- Turn the shaver off and disconnect the USB plug.
- Check that the socket cover is closed.



Cleaning with water

- Apply some hand soap and some water to the system outer foil.
- Press  and make foam for several seconds, then press  to stop making foam.
- Remove the outer foil section and clean with running water.
 - See page 17 for removing the outer foil section.



- After rinsing with water, shake the shaver up and down for a few times to remove excess moisture and then wipe off any drops of water with a dry cloth.

5 Dry the outer foil section and the shaver completely.

- Allow the shaver to dry in the shade, avoid direct sunlight.

6 Lubricate the shaver.

1. Apply one drop of oil to each of the system outer foils.
2. Switch the shaver on, and run it for approximately five seconds.
3. Switch off the shaver, and wipe off any excess oil from the system outer foil with a soft cloth.



Notes

- Be careful not to hit the main body on the sink or any other object while draining the water. Failure to do so may cause malfunction.
- Do not wipe with thinners, benzene, alcohol etc. Doing so may cause malfunction, cracking or discoloration of the parts. Wipe with diluted soapy water.
- Do not use any kitchen or bathroom detergents other than hand soap. Doing so may cause malfunction.

Cleaning with the brush

Remove the outer foil section and the inner blades. (See this page.)

Do not use any brush other than the supplied one.

► Cleaning with the short brush

- Clean the inner blades using the short brush by moving it in direction as illustrated.
- Do not move the short brush perpendicularly against the blades as it will damage the inner blades and affect their sharpness.



► Cleaning with the long brush

Clean the foil frame, system outer foil and the main body using the long brush.



► System outer foil

Clean the system outer foil in the areas indicated by the circles every time you use the shaver. Otherwise, abnormal sound may be generated.



Replacing the system outer foil and the inner blades

system outer foil	Approximately once every year*
inner blades	Approximately once every two years*

* The replacement timing is a recommendation and is subject to individual usage and preference.

Do not throw away the foil frame.

► Removing the outer foil section

Press the foil frame release buttons and lift the outer foil section upwards.

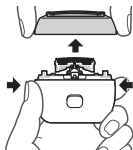

► Attaching the outer foil section

Align the foil frame (•) and the main body (•) marks, and securely attach it evenly until it clicks.

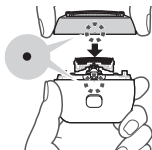

► Replacing the system outer foil

1. Press the system outer foil release buttons and pull down the system outer foil.

- Do not press the system outer foil release buttons with excessive force.

Doing so may bend the system outer foil, preventing complete attachment to the foil frame.

2. Align the foil frame (▲) and the system outer foil (▲) marks, and attach it until it clicks.

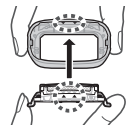

► Replacing the inner blades

1. Remove the inner blades one at a time.
2. Insert the inner blades one at a time.

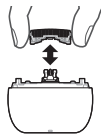

► Replacement parts and optional parts

Replacement parts and optional parts are available at your dealer or Service Center.

Replacement parts for ES-PV6A	System outer foil	WES9181
	Inner blades	WES9170
USB power adaptor		ES-RU1-02

Troubleshooting

Perform the following actions.

If the problems still cannot be solved, contact the store where you purchased the unit or a service center authorized by Panasonic for repair.

Problem	Action
The power switch does not turn ON.	► Unlock the switch lock. (See page 15.)

Problem	Action
The power will not switch to OFF.	▶ Press the power switch twice while using in shaving foam mode.
The shaving sensor does not respond.	▶ The shaving sensor may not respond when the remaining battery capacity is low. If this happens, recharge the shaver.
	▶ Apply oil. (See page 16.) The shaving sensor may not respond when there is not enough oil on the blades.
	▶ Depending on the beard thickness or the amount of beard trimmings in the shaver head, the shaving sensor may not react and the driving sound may not change. This is not abnormal.
	▶ The shaving sensor may not respond depending on the type and quantity of the shaving gel. This is not abnormal.

Problem	Action
The shaving sensor responds even though the shaver is not in contact with the skin.	▶ Clean the beard trimmings from the shaver. Clean the system outer foil with the brush. (See page 16.) When the shaver is extremely dirty, remove the foil frame and wash with water. (See page 15.)
	▶ Replace the system outer foil and/or inner blades.
Foam cannot be made in shaving foam mode.	▶ Making foam may be difficult depending on the type of facial cleansers etc., so adjust the amount of water or facial cleanser.
Foam made in shaving foam mode contains shavings.	▶ Before making foam, cleanly rinse off any shavings. (See page 15.)

Problem	Action
Operating time is short even after a full charge.	▶ When the number of operations per charge starts to decrease, the battery is nearing the end of its life.
	▶ Apply oil.
	▶ Clean the shaver.
Shaver does not operate even after charging.	▶ The usable number of days might be lower depending on how the shaver is used (for example, when used for wet shaving).
	▶ The shaver will not operate while it is connected to the household outlet.
	▶ Use the specified USB power adaptor and USB cable.
The driving sound changes while shaving.	▶ Use the appliance in an ambient temperature approximately 5 °C or higher.
	▶ The battery has reached the end of its life.
	▶ The shaving sensor is operating. The sound changes depending on the beard thickness.

Problem	Action
Makes a loud sound.	▶ Apply oil. The blades will not move smoothly when there is no oil on the blades, requiring more power.
	▶ The shaver makes a high-pitched sound due to the linear motor drive. This does not indicate a problem.
	▶ Confirm that the blades are properly attached.
The odor is getting stronger.	▶ Clean the system outer foil with the brush. (See page 16.)
	▶ Clean the shaver.
Shavings fly out in all directions.	▶ Clean the inner blades with the brush when shavings are adhering to the inner blades.
	▶ Apply oil.
System outer foil gets hot.	▶ Replace the system outer foil if it is damaged or deformed. (See page 16.)

Problem	Action
You do not get as close a shave as before.	▶ Clean the shaver.
	▶ Apply oil.
	▶ This can be improved by replacing the outer foil and/or inner blades.

Battery life

The life of the battery is 3 years. The battery in this shaver is not intended to be replaced by consumers. Have the battery replaced by an authorized service center.

Removing the built-in rechargeable battery

Remove the built-in rechargeable battery before disposing of the shaver.

The battery is to be disposed of safely. Please make sure that the battery is disposed of at an officially designated location if there is one. This figure must only be used when disposing of the shaver, and must not be used to repair it. If you dismantle the shaver yourself, it will no longer be waterproof, which may cause it to malfunction.

- Remove the shaver from the USB plug.

- Press the power switch to turn on the power and then keep the power on until the battery is completely discharged.
- Perform steps ① to ⑤ and lift the battery, and then remove it.
- Use a flat head screwdriver as shown.
- Take care not to short circuit the positive and negative terminals of the removed battery, and insulate the terminals by applying tape to them.

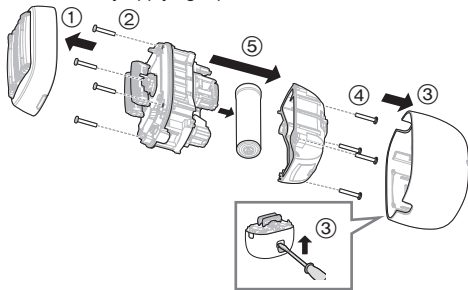

For environmental protection and recycling of materials
This shaver contains a Lithium-ion battery.
Please make sure that the battery is disposed of at an officially assigned location, if there is one in your country.

Specifications

Output rating of applicable adaptor (sold separately)	5.0 V $\overline{\text{---}}$ 1.0 A In compliance with the Safety Extra Low Voltage (SELV) system
Motor voltage	3.6 V $\overline{\text{---}}$
Charging time	Approx. 2 hours

This product is intended for household use only.

Panasonic

使用說明書
(家用) 充電式 刮鬍刀
型號 ES-PV6A

目錄

安全須知.....	24	更換外層網面及內層刀片	34
重要資訊.....	28	疑難排解.....	35
部件說明.....	29	電池壽命.....	37
充電.....	30	拆除內置充電電池.....	38
使用方法.....	31	規格.....	38
清洗.....	33		

感謝您購買本 Panasonic 產品。
使用本產品之前，請仔細閱讀本說明書，並妥善保存以供未來使用。

USB 電源供應器需另購。

安全須知

請務必依照以下指示。

為了防止意外、受傷或財物損失，請依照以下指示。

■ 以下符號表示不當使用而導致的受損程度。

 **危險** 表示潛在的危險會導致嚴重受傷或致命。

 **警告** 表示潛在的危險可能會導致嚴重受傷或致命。

 **注意** 表示潛在的危險可能會導致輕微受傷或財物損失。

■ 符號已按下方分類並作出解釋。

 此符號表示禁止。

 此符號表示必須遵循的要求。

警告

▶ 本產品

 本產品內置充電電池。請勿丟入火中、接近熱源或在高溫的環境中充電、使用、留置或存放在高溫的環境中。
- 否則可導致過熱、燃燒或爆炸。

 切勿改裝或自行維修產品。
- 否則可能導致火警、觸電或受傷。
請聯絡 Panasonic 直屬服務站進行維修（更換電池等）。

 切勿拆開本產品，棄置時除外。
- 否則可能導致火警、觸電或受傷。

▶ 電源供應

 切勿以超出家用電源插座或配線額定值的方式使用產品。
- 將太多插頭插至同一插座上，以致超出額定值，可能會因過熱而導致火警。

 必須完全插入 USB 電源供應器的電源插頭。
- 否則可導致火警或觸電。

 使用清水清潔主體時，請中斷連接 USB 插頭。
- 否則可導致觸電或受傷。

警告

▶ USB 電源供應器 /USB 電源線

切勿將 USB 電源供應器 /USB 電源線浸在水中或用水洗滌。

請勿將 USB 電源供應器 /USB 電源線放在有水的水池或浴缸上方或附近。



如 USB 電源供應器 /USB 電源線損壞，或電源插頭未緊接家用電源插座上，切勿使用本產品。切勿損壞 USB 電源供應器 /USB 電源線。

- 切勿破壞 USB 電源供應器 /USB 電源線表面、改裝、用力弄彎及拉扯。此外，切勿將重物放在 USB 電源供應器 /USB 電源線上、旋轉或夾緊它們。

- 否則可能會因短路而導致觸電或火警。

切勿使用 USB 電源供應器 /USB 電源線為其他裝置充電。



【請注意 USB 電源供應器 (ES-RU1-02) 可與 Panasonic 兼容的產品使用。】

- 否則可能會因短路而導致灼傷或火警。



切勿在手濕時將 USB 電源供應器 /USB 電源線插入家用電源插座或從插座中拔除。

- 否則可導致觸電或受傷。



為符合特低電壓或安全特低電壓 (SELV) 系統的要求，請務必將 USB 電源線插入額定電壓為 5.0 V、額定輸出電流為 1.0 A 的電源供應器中。

- 否則可能會因短路而導致燒傷或火警。



使用專用的 USB 電源供應器和 USB 電源線。
- 否則可能因短路而導致灼傷、觸電或火警。



應定期清潔 USB 電源供應器和 USB 電源線，以防止灰塵堆積。

- 否則濕氣可令絕緣失效，導致火警。
拔除 USB 電源供應器，然後用乾布擦拭。

▶ 若發生異常現象或故障

請立即停止使用產品及拔除 USB 電源供應器。
- 否則會造成火警、觸電或受傷。

< 異常或故障情況 >

• 主機、USB 電源供應器或 USB 電源線變形和異常灼熱。

• 主機、USB 電源供應器或 USB 電源線出現燒焦氣味。

• 主機在使用或充電時出現異常聲響。

- 請立即將產品帶往 Panasonic 直屬服務站，以要求檢查或維修。



▶ 避免意外



曾接受過醫療電子儀器移植手術的人士，請勿讓本產品接觸此類儀器植入處的皮膚表面。

- 此動作可能導致意外或身體不適。



切勿將產品放置在兒童或幼童可觸摸的地方。請勿讓兒童或幼童使用。

- 若把零件或配件放入口中，可能導致意外和受傷。

警告

如果不小心誤食潤滑油，不可催吐，請喝下大量的水，然後就醫。



如果潤滑油沾到眼睛，請立刻用清水沖洗，然後就醫。

- 否則可能導致身體不適。

▶ 也請留意下列注意事項

患有體能、感官或智力減退，或缺乏經歷和知識之人士（含小孩），在無人監護或未獲告知如何使用的情況下不得使用本產品。



請勿讓小孩使用本產品。

- 否則可能導致意外或受傷。

注意

▶ 保護皮膚

切勿用力壓下外層網面。此外，使用時切勿用手指或指甲觸碰外層網面。



切勿將本產品用於頭髮或身體任何其他部位的毛髮上。

- 否則可能導致皮膚受傷或縮短外層網面的壽命。

請勿施加過大力量，將外層網面加壓在嘴唇或臉上及其他部位。



請勿在暗瘡或受傷的皮膚上，直接使用外層網面。切勿接觸內層刀片的刀片（金屬）部分。

- 否則可能會導致身體皮膚受傷。



使用前，請檢查外層網面是否有破裂或變形。
- 否則可能導致皮膚受傷。

▶ 請注意以下注意事項



勿讓金屬物品或垃圾黏附在 USB 電源供應器的電源插頭或 USB 插頭上。

- 否則可能會因短路而導致觸電或火警。



充電插座處於濕狀態時請勿充電。

- 否則可能會導致觸電或火警。



請勿與家人或其他人共用鬚刨。

- 共用鬚刨可能會導致感染或發炎。



不充電時，應從家用電源插座拔出 USB 電源供應器。

- 否則可因絕緣劣化造成漏電，導致觸電或火警。

如何處置從廢棄產品中拆下的電池

危險



- 本充電電池僅能用於搭配此本產品使用。請勿將本電池搭配其他產品使用。
- 將電池從產品拆除後，請勿進行充電。
- 請勿丟入火中或加熱。
- 請勿撞擊、拆解、改裝或以指甲穿刺。
- 請勿讓電池的正極和負極端子透過金屬物質相互接觸。
- 請勿將電池與金屬飾品，如項鍊及髮夾等一起攜帶或存放。
- 切勿在高溫的位置使用或放置電池，例如在陽光直射或靠近其他熱源的地方。
- 請勿拆下電池直流管。
- 否則可導致過熱、燃燒或爆炸。

警告



- 拆除充電電池後，切勿放在孩童或嬰兒可取得的地方。
- 若意外吞下電池，會傷害身體。
- 若發生此情況，請立即就醫。



- 若電池液體外洩且接觸到眼睛，請勿揉搓眼睛，並使用清水（如自來水）徹底沖洗。
- 否則可能會導致眼睛受傷。
- 請立即就醫。

注意



- 若電池液體外漏且接觸到皮膚或衣物，請使用清水（如自來水）沖洗。
- 否則可能導致發炎。

重要資訊

- 此款乾 / 濕通用鬚刨可用於直接剃鬚，也可在塗抹剃鬚膏後進行濕式剃鬚。此鬚刨具防水功能，因此可在淋浴時使用，也可在水中清洗。以下符號表示可在盆浴或淋浴時使用。



- 連續三周使用剃鬚膏進行濕式剃鬚，您能體會到一些變化。由於您的皮膚和鬚鬚需要大約一個月的時間來適應新的剃鬚方式，因此您可能需要一點時間來適應此款 Panasonic 乾 / 濕兩用鬚刨。
- 將內層刀片保持在原有位置。如只有一塊內層刀片，鬚刨可能已經受損。
- 如您以水清洗鬚刨，請勿使用鹽水或熱水。切勿將鬚刨長時間浸泡於水中。
- 請根據使用說明書正確地為產品充電。（請參閱第 30 頁的「充電」。）
- 本產品所含的電池只能由技術人員更換。請聯絡 Panasonic 直屬服務站洽詢修理細節。

為防止產品故障、變形和劣化，請注意以下注意事項

- 切勿掉落，或者與其他物體發生碰撞。
- 請勿讓外層網面與堅硬的物體接觸。
- 拆卸網層後，切勿讓鬚刨直接曝曬在陽光下。
- 切勿使用風筒或其它產品的熱源將鬚刨風乾。
- 攜帶或存放時，務必將鬚刨放在保護蓋中。
- 使用後將鬚刨收納在低濕度的地方。

產品上的此符號表示不會產生高於安全特低電壓 (Safety Extra Low Voltage · SELV) 的電壓，其以供電的適當設計防止觸電事故。

III

部件說明

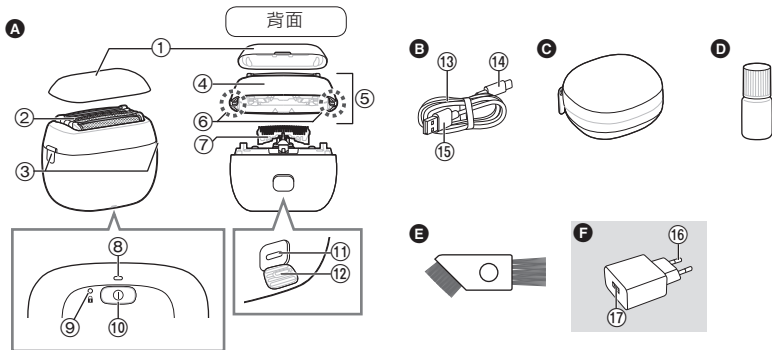

A 主體

- ① 保護蓋
- ② 外層網面
- ③ 網層拆除按鈕
- ④ 網層
- ⑤ 外層網面部分
- ⑥ 拆除外層網面的按鈕
- ⑦ 內層刀片
- ⑧ 充電狀態指示燈
- ⑨ 開關鎖定燈 (🔒)
- ⑩ 電源開關
- ⑪ 充電插座 (Type-C)

- ⑫ 插座保護蓋
- B USB 電源線**
- ⑬ 電源線
 - ⑭ USB 插頭 (Type-C)
 - ⑮ USB 插頭 (Type-A)

配件

- C 輕便旅行盒**
- D 潤滑油**
- E 清潔毛刷**

- F USB 電源供應器 (ES-RU1-02)**
(需另購)
- ⑯ 電源插頭
 - ⑰ USB 接口 (Type-A)

充電

- 關掉電源。
- 抹乾充電插座上的水滴。
- 使用專用的 USB 電源供應器和 USB 電源線。
- USB 電源供應器需另購。

1 打開插座保護蓋，然後將USB插頭牢固地插入主體和USB電源供應器。

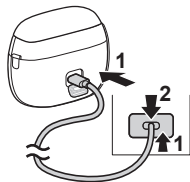

2 將USB電源供應器牢固地插入家用插座。

- 檢查充電狀態指示燈有亮起。
- 充電約 2 小時後完成。

3 充電狀態指示燈熄滅後，從家用插座拔除USB電源供應器，並從主體拔除USB插頭。

- 關上插座保護蓋。

註

您無法在充電時使用鬚刨。

▶ 電池電量不足時

- 鬚刨關閉後會發出兩次嗶聲。
- 操作鬚刨時，充電狀態指示燈會每秒閃爍一次。
充電狀態指示燈閃爍後，還可刮 2 到 3 次（視使用情況而異）。



▶ 註

- 鬚刨可以使用轉接器、USB 電源線進行充電，但為確保安全，建議使用具備防潑水設計功能的 Panasonic 專用轉接器及具過熱保護功能的 USB 電源線。轉接器不是完全防水，所以要避免弄濕。
- 充電完畢後，如果在鬚刨仍然插入電源插頭時，將電源開關打開，充電狀態指示燈就會亮起，並在 5 秒之後熄滅。
- 如果收音機或其他音訊來源在使用或充電本產品時發出噪音，請移到另一個地方使用本產品。
- 即使長時間（6 個月或以上）不使用電池也會劣化，因此請確保至少每 6 個月進行一次完整的充電。
- 鬚刨第一次充電或未使用超過 6 個月時，充電時間可能會有所改變，或者充電狀態指示燈可能會幾分鐘無法亮起。如繼續保持充電狀態，最後會亮起。
- 建議的充電環境溫度為 10°C 到 35°C。在溫度極高或極低的情況下對電池充電，可能需要較長的時間，或是電池可能無法正確充電。
充電發生問題時，充電狀態指示燈會每秒閃爍兩次。在建議的周遭環境溫度範圍內將鬚刨充電。
- 完全充電後，鬚刨大約可以使用 2 週。（此是根據每天在 20°C 到 30°C 的環境溫度範圍內使用乾式剃鬚 3 分鐘）
可使用的天數會因以下條件而有所差異：
 - 鬚鬚濃密度

- 施加到皮膚的力度
- 在泡沫製造模式中使用
- 濕式剃鬚的使用
- 由於鬚刨使用鋰電池，因此每次充電不會影響電池壽命。
- 維持電池充電不會影響電池性能。

使用方法

- 可用的洗面乳等。

		剃鬚	泡沫製造模式
剃鬚劑	剃鬚泡沫	✓	—
	剃鬚凝膠	✓	✗
	剃鬚膏	✗	✗
臉部清潔劑	臉部清潔泡沫 (不含磨砂膏)	✓	✓
	臉部清潔泡沫 (含磨砂膏)	✗	✗
	洗面皂	✓	✗
肥皂等	液體	✓	✓
	泡沫	✓	—

- 請勿使用上列以外的剃鬚劑 / 臉部清潔劑 / 肥皂等，因為它們可能會造成刀片阻塞或無法製造泡沫。

在泡沫製造模式下製造泡沫

用這方法製造泡沫比用手製泡沫簡單。

- 使用前，請檢查外層網面是否有破裂或變形。
- 請確保插座保護蓋已關上。

1 準備泡沫

將適量的面部潔面劑或類似物放於手中，然後加入適量的冷水或溫水。

2 按住 2秒鐘或2秒鐘以上，以轉換至泡沫製造模式。

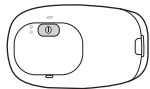

開關鎖定燈號 () 和充電狀態指示燈交替閃爍。



- 泡沫製造模式會在 15 秒後結束，接著即可開始剃鬚。
- 若要停止泡沫製造模式並開始剃鬚，請按下電源開關一次。

3 在您的手掌上輕輕地按下刀片，並混合手掌周圍的洗面乳等、在刀片上下挪動以製造泡沫。



- 若泡沫不足，增加少許水、熱水、或洗面乳，會更容易增加泡沫。

► 註

- 切勿使用剃鬚劑 (不包括剃鬚泡沫)、洗面乳 (含磨砂膏)、或肥皂，因為它們可能使刀片阻塞或無法製造泡沫。

剃鬚

1 按下 開始剃鬚。

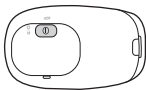

「偵感」刀頭震動系統會根據鬚鬚濃密自動調整功率運作。此將在鬚鬚濃密的地方以高功率剃鬚，在鬚鬚較少的地方降低功率以減低對皮膚的摩擦。

達成更好的剃鬚方式建議

以外層網面垂直的方式靠貼皮膚，並將鬚刨輕輕朝您臉部的鬚鬚處滑動以剃鬚。

• 此可伸展皮膚，讓鬚鬚豎起，更徹底地剃除下巴下方與喉嚨周圍的鬚鬚。

• 為避免損壞外層網面，切勿在僅有一部份的外層網面接觸的情況下剃鬚。

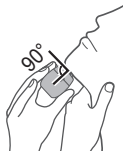

2 完成後，請按下 。

▶ 註

• 如果環境溫度低於約 5°C，則本產品可能無法運作。

- 視剃鬚膏的種類或泡沫量而定。「偵感」刀頭震動系統可能會沒有反應，這不是異常情況。
- 濕式剃鬚之後，請用水清洗主體，然後在外層網面上油。



開關鎖定的操作及顯示

▶ 鎖定電源開關

1. 按下  一次，然後放開。

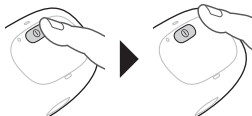
• 鬚刨開始運作。



2. 按住  超過 2 秒，直到開關鎖定燈 () 開啟。

• 鬚刨將停止運作。





3. 然後放開  。

• 開關鎖定燈 () 在 5 秒後熄滅。





▶ 解除鎖定電源開關

1. 按住  超過 2 秒，直到開關鎖定燈 () 熄滅。

• 開關鎖定燈 () 將熄滅。

• 鬚刨開始運作。

2. 然後放開  。

當開關鎖定燈 () 閃爍 5 秒時，電源開關為鎖定，此時即使按壓電源開關，鬚刨還是無法使用。





清洗

- 我們建議在每次使用後即清潔鬚刨。
- 將鬚刨關閉，並中斷連接 USB 插頭。
- 請確保插座保護蓋已關上。



請用水清潔

- 1 在外層網面上塗抹一些肥皂和水。
- 2 按下  幾秒以製造泡沫，然後按下  以停止製造泡沫。



- 3 取出外層網面部分，並使用自來水清潔。



- 請參閱第 34 頁，以獲得如何移除外層網面部分的資訊。

- 4 使用清水沖洗後，請上下甩動鬚刨數次，清除多餘水氣，然後使用乾布抹乾鬚刨。

- 5 讓外層網面部分和鬚刨完全風乾。

- 將鬚刨在陰暗處自然風乾，避免陽光直射。

- 6 請使用潤滑劑潤滑鬚刨。

1. 在每層外層網面上放上一滴潤滑油。
2. 啟動鬚刨，然後運作約五秒。
3. 關掉鬚刨，然後以軟布抹去外層網面多餘的潤滑油。



註

- 排水時，小心不要讓主體撞到水槽或其他物件。否則可能造成故障。
- 切勿使用稀釋劑、石油精、酒精等擦拭。否則可能會造成故障，或部件斷裂或褪色。請使用稀釋過的肥皂水擦拭。
- 切勿使用手工皂以外的任何廚房或浴室清潔劑。否則可能造成故障。

以毛刷清潔

取出外層網面部分與內層刀片。

(請參閱本頁。)

除了原本提供的清潔毛刷外，請勿使用其他刷子。

▶ 用短毛刷清潔

- 利用毛刷依所示方向來清潔內層刀片。
- 切勿以跟刀片垂直的方向使用短刷，因此舉會損壞內層刀片，使刀片不鋒利。



▶ 用長毛刷清潔

利用長刷來清潔網層、外層網面和主體。



▶ 外層網面

每次使用鬚刨時請清潔圖圈指示範圍的外層網面。否則可能會發出異常聲。



更換外層網面及內層刀片

外層網面	約每年一次 *
內層刀片	約每兩年一次 *

* 更換時間僅供參考，實際更換時間視個人使用情況及偏好而定。
請勿丟棄網層。

▶ 取下外層網面部分

按下網層拆除按鈕，並向上提起外層網面部分。

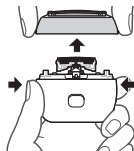

▶ 裝上外層網面部分

對準網層標誌 (•) 和主體 (•) 標誌，然後牢固地安裝在一起，直到發出卡入聲。

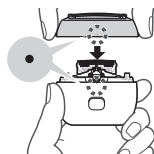

► 更換外層網面

1. 按著拆除外層網面的按鈕，拉下外層網面。
 - 切勿以過大力道按下拆除外層網面的按鈕。
否則可能會導致外層網面彎曲，並使網層無法完全連接。
2. 對準網層標誌 (▲) 和外層網面 (▲) 標誌，然後牢固地安裝在一起，直到發出卡入聲。

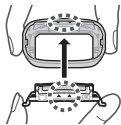

► 更換內層刀片

1. 拆掉內層刀片。
2. 一次插入內層刀片到定位。

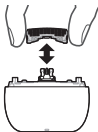

► 更換零件和選用零件

您可以在經銷商或 Panasonic 直屬服務站購買更換零件和選用零件。

ES-PV6A 的更換零件	外層網面	WES9181
	內層刀片	WES9170

USB 電源供應器	ES-RU1-02
-----------	-----------

疑難排解

請執行以下操作。

如果仍然無法解決問題，請與您購買本產品的商店聯繫，或洽 Panasonic 直屬服務站進行維修。

問題	解決辦法
電源開關無法切換到開啟。	解除鎖定開關鎖定。(請參閱第 32 頁。)
電源不會關閉。	在泡沫製造模式中使用時，按下電源開關兩次。

問題	解決辦法
「偵感」刀頭震動系統沒有反應。	剩餘電池電量很低時，「偵感」刀頭震動系統可能不能作出感應。若發生此狀況，請重新將鬚刨充電。
	塗上潤滑油。（請參閱第 33 頁。） 刀片上的潤滑油不足時，「偵感」刀頭震動系統可能會沒有反應。
	依鬚髮濃密度或鬚髮修剪量而定，「偵感」刀頭震動系統可能無法做出反應，且驅動聲音可能不變。這不是異常情況。
	視剃鬚膏的類型與分量而定，「偵感」刀頭震動系統可能無法作出反應。此並非異常現象。
即使鬚刨未與皮膚接觸，「偵感」刀頭震動系統仍會有反應。	清潔鬚刨中剃落的鬍子。以毛刷清潔外層網面。（請參閱第 34 頁。） 鬚刨很髒時，請除去網層並用水清洗。（請參閱第 33 頁。）
	更換外層網面或內層刀片。

問題	解決辦法
在泡沫製造模式下無法製造泡沫。	視洗面乳的類型而定，可能會難以製造泡沫，所以請調整水量或洗面乳。
在泡沫製造模式中，所製造的泡沫含有鬚髮屑。	製造泡沫之前，把任何鬚髮屑沖洗乾淨。（請參閱第 33 頁。）
即使充滿電，操作時間仍然很短。	當每次充電後的操作次數開始減少時，表示電池已經接近使用壽命的終點。
	塗上潤滑油。
	清潔鬚刨。
即使充電後，鬚刨仍不運作。	根據使用鬚刨的方式（例如用於濕式剃鬚），使用天數可能會減少。
	鬚刨連接至家用插座時無法操作。
	使用專用的 USB 電源供應器和 USB 電源線。
	在溫度約 5 °C 或以上的環境中使用本產品。
	電池已達到使用壽命的終點。

問題	解決辦法
剃鬚時，驅動聲有變化。	▶ 「偵感」刀頭震動系統正在運作中。聲音會因鬍子濃密度而變化。
發出很大的聲響。	▶ 塗上潤滑油。 當刀片上沒有潤滑油時，刀片就無法順暢移動，且需要更多電力。
	▶ 鬚刨可能因線性摩打的緣故發出很大的聲響。這並不是異常情況。
	▶ 確認已妥善裝上刀片。
	▶ 以毛刷清潔外層網面。（請參閱第 34 頁。）
臭味越來越濃。	▶ 清潔鬚刨。
剃落的鬍子四處飛濺。	▶ 若鬍子沾黏到內層刀片，請使用毛刷清潔內層刀片。
外層網面變熱。	▶ 塗上潤滑油。
	▶ 換掉損壞或變形的外層網面。（請參閱第 34 頁。）
您無法像之前將鬍子剃得那麼乾淨。	▶ 清潔鬚刨。
	▶ 塗上潤滑油。
	▶ 更換外層網面和 / 或內層刀片可以改善這個情況。

電池壽命

電池使用壽命為 3 年。使用者不應自行更換本鬚刨中的電池。請交由 Panasonic 直屬服務站來更換電池。

拆除內置充電電池

此鬚刨內的電池請勿由消費者自行替換。

將電池安全棄置。

如您的國家 / 地區有指定認可棄置電池的地方，請確保將電池棄置於這些地方。

下圖只能用於棄置鬚刨時。切勿使用下圖作維修之用。若您自行拆解鬚刨，產品就不再具有防水功效，並可能會導致產品損壞。

- 將鬚刨從 USB 插頭拔除。
- 按電源開關接通電源，保持電源的開啟狀態直至電池完全放電。
- 執行步驟 ① 至 ⑤ 以拉出並拆除電池。
- 請使用圖示的一字螺絲批。
- 請小心，不要讓已移除電池的正負極端子發生短路，且必須在端子上使用膠帶使其絕緣。

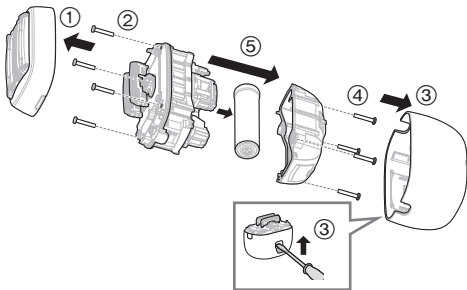

環保及資源回收

此鬚刨內藏鋰電池。

如您的國家有指定認可棄置電池的地方，請確保將電池棄置於這些地方。

規格

適用轉接器 (需另購) 額 定輸出	5.0 V=== 1.0 A 符合安全特低電壓 (Safety Extra Low Voltage, SELV) 系統的要求
發動機電壓	3.6 V===
充電時間	約 2 小時

此產品只適於家居內使用。

Panasonic Corporation
<https://www.panasonic.com>
© Panasonic Corporation 2024