



OPERATING INSTRUCTIONS

使用說明書

Ziaino Air Treatment Unit

空間除菌脫臭機

Model No. 型號 **F-JPT70H**

This product is for indoor use only

本產品為室內專用

CONTENTS

SAFETY PRECAUTIONS	2~6
SETTING REQUIREMENTS	7
OPERATING REQUIREMENTS	7~8
EACH PARTS IDENTIFICATION	8~10
OPERATION	11~13
WATER SUPPLY/DRAINAGE METHOD	13~15
ADDING A SALT TABLET	15
MAINTENANCE	16~24
WHEN REPLACING THE ELECTRODE UNIT	22~23
WHEN IDLE FOR A LONG TIME	24
OPTIONAL ACCESSORIES	24
TROUBLESHOOTING	25~27
LIST OF ERROR CODES	27
SPECIFICATIONS	BACK COVER

目錄

安全注意事項	2~6
設置要求	7
使用要求	7~8
各部件名稱	8~10
使用方法	11~13
供水/排水方法	13~15
• 投入鹽粒	15
維護保養	16~24
• 更換電極組件時	22~23
• 長期間置時	24
自選配件	24
故障排除	25~27
• 異常碼一覽表	27
規格	末頁

確認與設置
AND SETUP

使用方法
OPERATION

維護保養
MAINTENANCE

其他信息
OTHER INFORMATION

Thank you for purchasing this Panasonic product.
Please read these operating instructions carefully before operation and maintenance.
Also, be sure to read the "SAFETY PRECAUTIONS" section (P.2~6) before use.
Failure to comply with instructions could result in injury or property damage.
Please retain this booklet for future reference.

感謝您選購Panasonic產品。
使用和維護產品前，請仔細閱讀本使用說明書。
使用前請務必先閱讀“安全注意事項”（第2~6頁）。
不遵照本說明書進行操作有可能導致受傷或財產損失。
請妥善保管好此說明書以備日後參考。

SAFETY PRECAUTIONS

安全注意事項

Please strictly follow
請務必遵守

- Disconnect power supply before maintenance and filling water.
維護保養和加水前先斷電。
- For cleaning and descaling see "maintenance" and regarding filling (water supply) see "WATER SUPPLY/DRAINAGE METHOD".
清潔和除垢詳情請參照“維護保養”。關於加水詳情請參照“供水/排水方法”。
- If the supply cord is damaged, it must be replaced by the manufacturer, its service agent or similarly qualified persons in order to avoid a hazard.
如果電源軟線損壞，為了避免危險，必須由製造商、其維修部或類似部門的專業人員更換。
- This product is not intended for use by persons (including children) with reduced physical, sensory or mental capabilities, or lack of experience and knowledge, unless they have been given supervision or instruction concerning use of the product by a person responsible for the safety. Children should be supervised to ensure that they do not play with the product.
本產品不適合有殘疾、智障或精神障礙的人士或缺乏經驗、常識者(包括兒童)維護使用，除非在負責他們安全的人士的看護或指導下使用。兒童應該有人進行看護，以防將產品當作玩具。

The safety precautions should be strictly followed in order to prevent injury or damage to properties. 為了避免對您或其他人造成傷害或財物損害，請務必遵守安全注意事項。

- The following symbols differentiate the levels of danger or injury that may result if the product is not used correctly as instructed.
以下標誌是根據不按指示使用產品所產生的危險或受傷程度進行分類。

WARNING 警告

Those things shown in this column indicate that there is possibility of causing death or severe injury.

本標誌所表示的內容為“不遵守的話可能造成人員死亡或重傷”。

CAUTION 注意

Those things shown in this column indicate that there is possibility of causing minor injury or damage to properties.

本標誌所表示的內容為“不遵守的話可能造成人身輕傷或財物損害”。

- The following symbols are used to indicate the type of instructions that need to be followed. (The symbols given below are examples.)
以下標誌為務必遵守的指示種類。(下列標誌為例子。)



This symbol indicates an action that must not be performed.
此標誌表示禁止事項。



This symbol indicates an action that must be performed.
此標誌表示強制事項。

WARNING 警告



- Do not pull the power cord when carrying or storing the product.
移動或存放時禁止拉扯電源線。

(Otherwise, the power cord may be damaged with the possibility of fire or electric shock.)
(否則電源線可能會損壞，導致火災或觸電。)

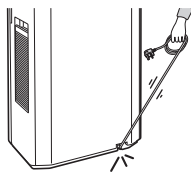

- Do not insert your fingers, metallic objects or others into the air inlet, air outlet or gaps.
禁止將手指或金屬物等異物放入進風口、出風口或縫隙中。

(Otherwise, you may be hurt by the inner units with the possibility of electric shock or injury.)
(否則可能會接觸到產品內部，導致觸電或受傷。)



- Insert the power plug into the power socket completely.

請將電源插頭完全插入電源插座。
(If the power plug is not fully inserted, electric shock may occur, or a fire may be caused due to overheating of the power cord.)
(如果電源插頭沒有完全插牢，可能會導致觸電，或因電源線過熱導致火災。)



- Do not use damaged power plug or loose power socket.
禁止使用已損壞的電源插頭或鬆動的電源插座。



- Do not use acid detergents or citric acid.

禁止使用酸性洗滌劑或檸檬酸。
(Otherwise, toxic gas may be produced, which is harmful to your health.)
(否則可能產生有毒氣體，危害健康。)

WARNING 警告



- Do not damage the power cord or power plug.
禁止損壞電源線或電源插頭。
 - Do not cut, modify, excessive distort, twist, squeeze the power cord, and do not place it near heat sources, place heavy weight on it, etc.
禁止切割、改裝、過度扭曲、擰絞、擠壓電源線、使電源線靠近熱源以及在電源線上壓放重物等。
(Otherwise, the power cord may be damaged with the possibility of fire or electric shock.)
(否則電源線可能會損壞，導致火災或觸電。)

- Do not touch the power plug with wet hands.
禁止用濕手接觸電源插頭。
(Otherwise, electric shock may occur.)
(否則可能會導致觸電。)



- Do not let the product get wet.
禁止弄濕機體。
 - Do not place cups, etc. on the main unit.
禁止在機體上放置水杯等。
(Otherwise, the product may short circuit with the possibility of fire or electric shock.)
(否則產品可能會短路，導致火災或觸電。)

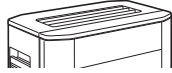

- For hospitals, rehabilitation centers or the like, please pay attention to the operating places of this product. Make sure that customers with implanted medical pacemakers keep their pacemaker implantation sites away from the opening and closing part of the front panel, water supply tank, drain tank and tray of this product.

醫院、康復機構等請注意本產品的使用場合，禁止使用醫療起搏器的顧客讓起搏器的植入部位靠近本產品前面板開合處、供水水箱、排水水箱和水盤。
(Otherwise, the magnets on the product may negatively affect the pacemaker.)
(產品上有磁鐵，可能會對起搏器造成不良影響。)



- Clean the power plug regularly.

請定期清潔電源插頭。
(If dust and humidity is found on the power plug, which may cause damage to insulation, causing fire.)
(如果電源插頭上有灰塵、濕氣，可能會破壞電源插頭的絕緣部分，導致火災。)

- Disconnect the power plug and wipe it with dry cloth.

拔出電源插頭，用乾布擦淨。

- When the product will not be used for a long period, disconnect the power plug.

產品長期不使用時，應拔出電源插頭。

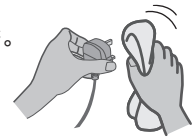

- In case of any abnormality or malfunction, immediately stop using the product and disconnect the power plug.

出現異常現象或故障時，應立即停止使用，並拔出電源插頭。

(Otherwise, electric shock, fire or smoke may occur.)

(否則可能導致觸電、起火或冒煙。)

<Examples of abnormality/malfunction>
<異常·故障的例子>

- Leakage.
漏水。
- Operation stops after the power cord is touched.
觸碰電源線後，運轉停止。
- Abnormal noise or severe vibration occurs during operation.
運轉時伴有異常噪音或劇烈振動。
- The main unit becomes abnormally hot or emits a smell of burning.
主機異常發燙、或散發出燒焦的異味。
- There is any other abnormalities or malfunction.
存在其他異常和故障。

→ Please stop operating immediately and disconnect the power plug, and contact the dealer to check and repair.

立即停止運轉，拔下電源插頭，聯繫經銷商進行檢查、維修。



- Do not disassemble or modify the electrode unit.

禁止擅自拆開電極組件。

(Injury may be caused due to the electrode plates after disassembly.)

(拆開後可能會因電極板等而導致受傷。)



WARNING 警告



- Be sure to only use an AC power supply of 220 V and 50 Hz, instead of any power supplies, universal outlets or connecting devices exceeding the rated values.

禁止使用超出額定值的電源，萬能插座或連接設備，只可使用 220 V~ 50 Hz 的（交流）電源。
(Otherwise, the power cord may be overheated, thus resulting in a fire.)
(使用超出額定值的萬能插座或連接設備，可能會導致電源線過熱，引起火災。)



- Do not disassemble or modify the product.

禁止擅自拆開或改裝本產品。

(Otherwise, the product may catch fire or malfunction, thus resulting in fire or electric shock.)

(否則產品可能導致起火或運作異常，引發火災或觸電。)

- Contact the dealer for repair.
需要維修時請聯繫經銷商。



CAUTION 注意



- Do not place the product in the incline and unstable place or at heights.

禁止放置於不平穩的場所和高處。

(Otherwise, the product may fall over and injury may occur, the water may spill out and fire, electric shock may occur or wet furniture, etc.)

(否則產品可能會翻倒，導致受傷，水灑出會導致火災、觸電、沾濕傢俱等。)

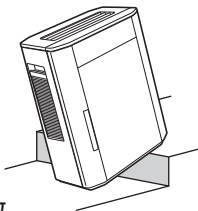

- Do not place the product in the place where oil fume is emitted, such as in kitchens.

禁止放置於廚房等排放油煙的場所。

(Otherwise, the product may crack and injury may occur.)

(否則產品可能會出現裂紋，導致受傷。)

- Do not place the product in the place where the temperature or humidity is extremely high, or watery area, such as bathroom.

禁止放置於浴室等高溫、高濕或會弄濕產品的場所。

(Otherwise, current may leak with the possibility of fire or electric shock.)

(否則產品可能會漏電，導致火災或觸電。)



- Do not use the product in the place where the air outlet faces animals or plants directly.

禁止放置於風口對著動植物的場所使用。

(Otherwise, it may cause discomfort to the animals and dry out the plant.)

(否則可能會導致動物不適、植物風乾。)

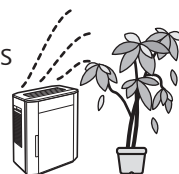

- Do not use the product in the place where oil or inflammable gas may be leaked.

禁止放置於油或可燃性氣體可能出現洩漏的場所使用。

(Otherwise, a fire or smoke may occur due to ignition in the product.)

(否則可能因產品吸入而導致起火或冒煙。)

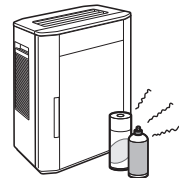

- Do not sit on or lean against this product.

禁止坐、靠本產品。

(Otherwise, the product may fall over and injury may occur, the water may spill out and fire, electric shock may occur or wet furniture, etc.)

(否則產品可能會翻倒，導致受傷，水灑出會導致火災、觸電、沾濕傢俱等。)

- Families with children should pay more attention.
有小孩的家庭要多加注意。

⚠ CAUTION 注意



- Do not push over or overturn the product.

禁止推倒或倒置本產品。

(Otherwise, the water may spill out and fire, electric shock may occur or wet furniture, etc.)

(否則水灑出可能會導致火災、觸電或沾濕傢俱等。)

- Do not operate this product in places where indoor fumigation type insecticides are being used.

煙霧型殺蟲劑使用時，禁止運轉產品。

(Otherwise, chemical residue may build up inside the product and discharge from the air outlet, which is harmful to your health.)

(否則產品內可能會積聚藥物，然後從出風口排出，危害身體健康。)

- Ventilate the room with fresh air thoroughly after using insecticides before operating the product.

使用殺蟲劑後，應先讓房間徹底通風，然後才可運轉產品。

- Do not clean the product with gasoline or other volatile mixture solvents, and avoid contacting with spray insecticides.

禁止使用汽油或其他揮發性混合溶劑擦拭產品，以及把殺蟲劑噴到產品上。

(Otherwise, the product may crack or short circuit with the possibility of injury, fire or electric shock.)

(否則產品可能會破裂或短路，導致受傷、火災或觸電。)

- Do not place the product near combustible materials such as lighted cigarette, incense, etc.

禁止將點燃的香煙、香燭等可燃物接近產品。

(Otherwise, these may be absorbed into the product with possibility of fire.)

(否則易燃物可能會被吸入產品內起火，導致火災。)



- Do not drink the water in the water supply tank, drain tank or tray, or feed animals or water plants with it.

禁止飲用供水水箱、排水水箱、水盤的水，或供給動植物。

(Otherwise, human health may be harmed and adverse effects may be caused.)

(否則會危害人體健康及造成不良影響。)

- Do not use a punctured or damaged water supply tank, drain tank or tray.

禁止使用開孔或破損的供水水箱、排水水箱、水盤。

(Otherwise, discoloration or deterioration of the floor may be caused.)

(否則可能會導致地板等變色或變質。)

- Do not add chemicals, air fresheners, essential oils, etc. into the water supply tank or tray.

禁止將化學藥品，芳香劑，精油等放入供水水箱或水盤裡。

(Otherwise, toxic gas may be produced, which is harmful to your health. Or, the water supply tank or tray may be damaged, thus wetting the floor and resulting in discoloration or deformation.)

(否則可能會產生有毒氣體，危害身體健康。或者可能會導致供水水箱或水盤破損後沾濕地板等，並導致變色或變質。)

- Do not let the wind blow directly onto walls or hand-rails or any other metal objects.

禁止讓風直接吹向牆壁或扶手等金屬物。

(Otherwise, dirt, mold or rust may be caused.)

(否則可能會產生污漬、發霉，或生鏽等。)

⚠ CAUTION 注意



- When disconnecting the power plug, hold the power plug instead of the power cord.

請手持電源插頭部位拔出電源插頭。
(Otherwise, the power cord may be damaged with the possibility of fire or electric shock.)
(否則電源線可能會損壞, 導致火災或觸電。)

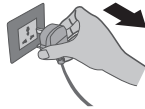

- Keep the room well-ventilated when using the product together with a burner.

與燃燒器具一起使用時, 需保持空氣流通。
(Otherwise, carbon monoxide poisoning may occur.)
(否則可能會導致一氧化碳中毒。)



- This product cannot remove carbon monoxide.
本產品不能去除一氧化碳。

- When carrying the product. 移動產品時。

- Turn off the product and disconnect the power plug, take out the tank, and pour water out of the water supply tank, drain tank and tray.
請停止運轉產品並拔出電源插頭, 將供水水箱、排水水箱及水盤裡的水倒空。
(Otherwise, discoloration or deterioration of the floor may be caused.)
(否則可能會導致地板等變色或變質。)
- Hold the left and right handles, but not the louver, operation part cover, and the front panel to carry the product.
請握住左右把手, 不可握住導風板、操作部蓋、前面板移動產品。
(Otherwise, the product may slip out injury may occur.)
(否則產品可能發生滑落, 導致受傷。)



- Make sure that no water spills out when carrying the water supply tank, drain tank or tray. If any water spills out, wipe it off immediately.

在搬運供水水箱, 排水水箱, 水盤時, 請確保在水不會灑出的狀態下搬運。如果有水灑出, 請及時擦掉。
(If water spills out on the floor, etc., discoloration or deterioration may be caused due to the bleaching effect of hypochlorous acid.)
(水如果灑到地板等上面, 會由於次亞鹽素的漂白作用而導致變色或變質。)

- When draining the water, turn on the tap to flush the sink clean.

排水處理時, 請同時打開自來水, 將水槽沖洗乾淨。
(Otherwise, the sink and water pipe may oxidize to form rust.)
(否則有可能導致水槽和水管管道等氧化(生鏽)。)

- Clean the water supply tank, the drain tank and the interior of the main unit frequently.

要經常清潔供水水箱、排水水箱及主機內部。
• Replace the water in the tank with new tap water every day.
請每天用新的自來水替換供水水箱的水。
(When the product is not operating, a foul odor may occur due to mildew and miscellaneous bacterium breeding caused by dirt or incrustation, which may be harmful to your health.)
(產品不運轉時, 由於髒漬和水垢而引起的發霉和雜菌繁殖, 可能會產生臭味或危害人體健康。)

- When you feel uncomfortable, stop using the product immediately and consult a doctor at once.

使用期間如感覺身體出現異常, 請立即停止使用, 及時就醫。
(Otherwise, physical discomfort may be caused.)
(否則會引起身體不適。)

SETTING REQUIREMENTS

設置要求

- When used beside a wall, etc.
在牆壁等的旁邊使用時
Keep a safe distance during use as instructed below.
請保持以下安全距離進行使用。
(Poor ventilation may cause the internal temperature of the main unit to rise, thus resulting in malfunction.)
(通風不暢時會導致主機內部溫度上升，引起故障。)

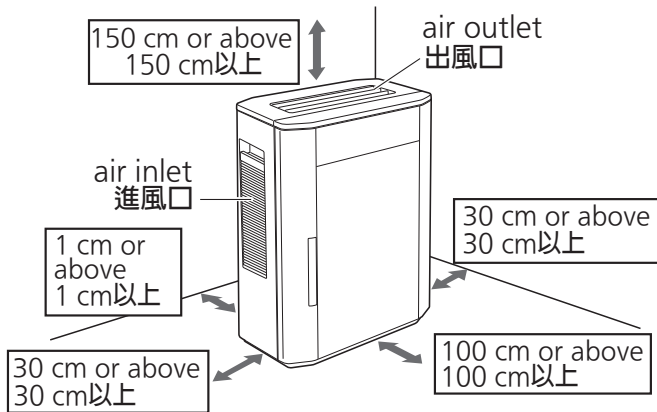

- Do not put any obstacles at the inlet and outlet of the product.
請勿在產品進風口和出風口處放置障礙物。
(Otherwise, it may affect product performance.)
(否則可能會影響產品性能。)

- Place the main unit indoors and use it within the ambient temperature range of 5 °C to 35 °C.
請將主機置於室內，在5 °C至35 °C的環境下使用。
- Do not set the product in the following places.
請勿設置本產品於以下場所。
 - Where the product will be exposed directly to sunlight, outlet of air conditioner or heat, etc.
陽光直射、被空調吹到或受熱等場所。
(Otherwise, deformation, deterioration, discoloration or malfunction may be caused.)
(否則可能會造成變形、變質、老化、變色或誤動作。)
 - Near objects such as TV and radio.
電視機及收音機等物體附近。
(Otherwise, visual disturbances or noises may be caused.)
(否則可能會導致影像紊亂以及雜音。)
- Keep a distance of 1 m or above.
距離1 m以上設置。
- Do not use the same power socket with TV, radio, etc.
請勿與電視機、收音機等設備使用同一電源插座。
(Otherwise, visual disturbances or noises may be caused when inserting the power plug.)
(電源插頭插入時有可能會產生影像紊亂以及雜音。)
- In this case, insert the power plug into another power socket.
請將電源插頭插到其他電源插座上。

OPERATING REQUIREMENTS

使用要求

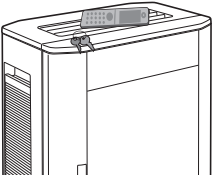
- Do not place any object on the product.
請勿在產品上放置物品。
(Otherwise, the product may malfunction.)
(否則產品可能錯誤操作或故障。)
- 
- Do not use the product with the air inlet filter removed.
請勿在取出進風口過濾網的狀態下使用本產品。
(Otherwise, dust may build up inside the main unit, thus resulting in malfunction.)
(否則會導致主機內部灰塵積聚，引起故障。)
 - Do not disconnect the power plug unless the product will not be in use for a long time.
如果不是長時間內關機的情況下，請勿拔出電源插頭。
(Otherwise, mildew and miscellaneous bacterium breeding may be caused as sterilization is not available.)
(由於無法除菌，可能會引起發霉和雜菌繁殖。)
- Make sure that there is water in the water supply tank and keep the power plug inserted since the cleaning operation (Page 13) will start automatically once the product stops working.
停止工作時，將會自動進行清潔運轉(第13頁)，因此請確認供水水箱內有水，切勿拔下電源插頭。

- Clean the walls regularly.
請定期清潔牆壁等。
Using the product continuously at the same location may result in dirty surrounding walls due to the air inhaled by the product. You are recommended to clean the walls regularly.
如果一直在同一個場所使用，主機周圍的牆壁等可能會因為本產品吸入的空氣而變髒。建議定期清潔牆壁等。
- When there may be freezing, please empty the water supply tank, drain tank and tray.
有可能發生凍結時，請倒掉供水水箱，排水水箱和水盤的水。
(Operating with frozen water may cause malfunction.)
(使用凍結的水運轉，可能會導致故障。)
- Do not block the air outlet.
請勿堵塞出風口。
(Otherwise, misoperation or malfunction may be caused.)
(否則有可能導致操作錯誤、故障。)

OPERATING REQUIREMENTS

使用要求

- If the product will not be in use for a long time, disconnect the power plug, and empty the water supply tank, drain tank and tray.
長時間停機請拔下電源插頭，並倒掉供水水箱、排水水箱、水盤的水。
(Otherwise, it may cause mildew and miscellaneous bacterium breeding since the effect of hypochlorous acid is weakened while the power is off.)
(由於不通電，次亞鹽素酸的效果減弱，會引起發霉和雜菌繁殖。)
- There is no problem if the power plug is disconnected briefly.
短暫拔下電源插頭時不會產生影響。
- Do not use the product in a smoking environment.
請勿在吸煙環境下使用。
(Otherwise, performance degradation may be caused and the replacement cycle of the electrode unit, sterilization filter and dust filter may be shortened.)
(否則會導致功能下降，電極組件、除菌過濾網、集塵過濾網的更換時間提前。)
(If the product inhales cigarette smoke, the interior of the main unit may become dirty with cigarette tar, and dirty water containing cigarette tar or other components may be blown out from the main unit.)
(如吸入香煙煙霧會由於煙焦油等而導致主機內部髒污，含有煙焦油等成分的髒水可能會從主機裡吹出。)

About the salt tablet 關於鹽粒

- The salt tablet is applicable to this product only.
鹽粒僅用於本產品。
- Be sure to use the supplied or optional salt tablet (Page 24).
請務必使用附屬品或自選配件(第24頁)的鹽粒。
- Be sure to add one salt tablet into the tray after water is supplied.
供水之後，請務必向水盤投入1粒鹽粒。
(If no salt tablet is added, the effect of hypochlorous acid may be weakened or even completely eliminated.)
(如不投入鹽粒，次亞鹽素酸的效果將會減弱甚至沒有效果。)
- Tighten the cover to keep the salt container sealed after unpacking.
開封後請擰緊蓋子保持密封。
- Do not swallow any salt tablets.
請勿吞食鹽粒。
 - If salt tablets are swallowed by accident, drink enough water immediately. (It is recommended to drink 500 ml water per salt tablet.)
若不小心吞食了鹽粒，請立即飲用足夠的水。
(1粒鹽粒按500 mL水計算)
 - If too many salt tablets are swallowed, or if a patient with hypertension or heart disease swallows salt tablets by accident, consult a doctor at once.
一時吞食過量鹽粒，或者是高血壓、心臟病患者誤吞食的情況下，請及時就醫。

EACH PARTS IDENTIFICATION

各部件名稱

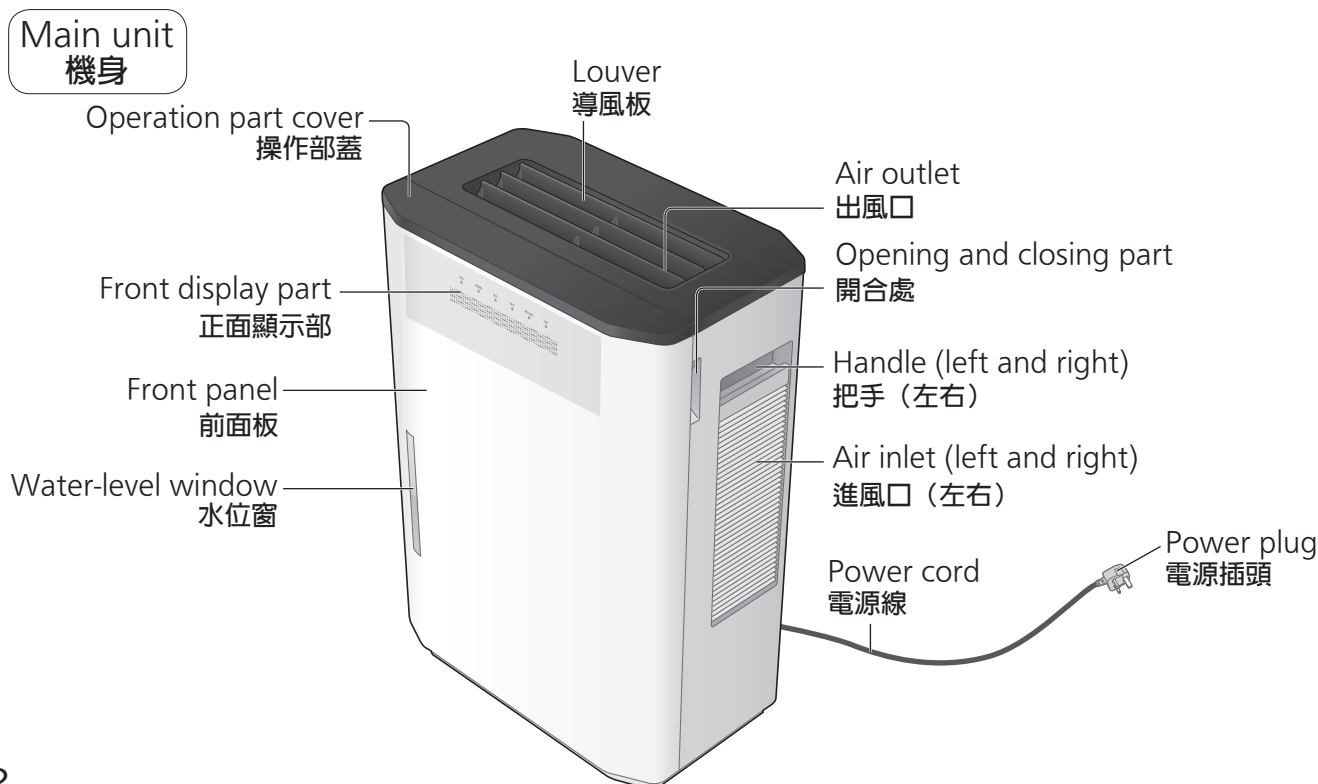

EACH PARTS IDENTIFICATION

各部件名稱

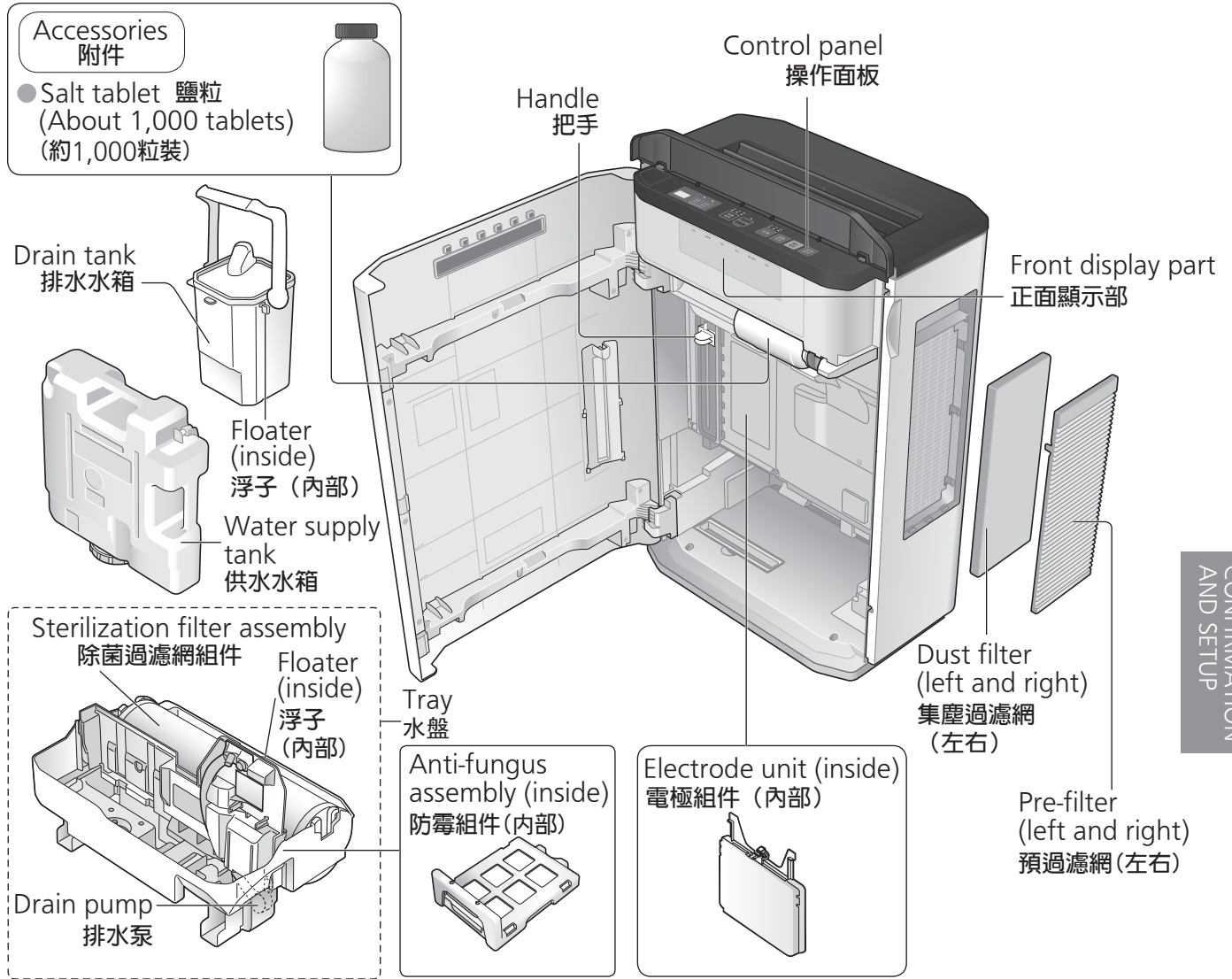

確認與設置
CONFIRMATION
AND SETUP

Control panel 操作面板

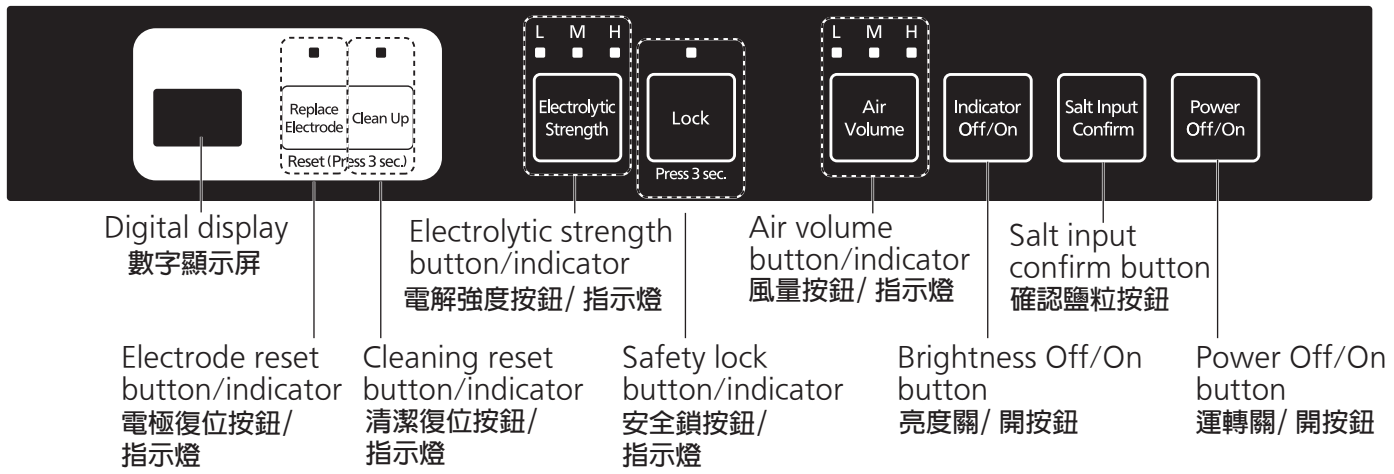

EACH PARTS IDENTIFICATION

各部件名稱

Front display part 正面顯示部

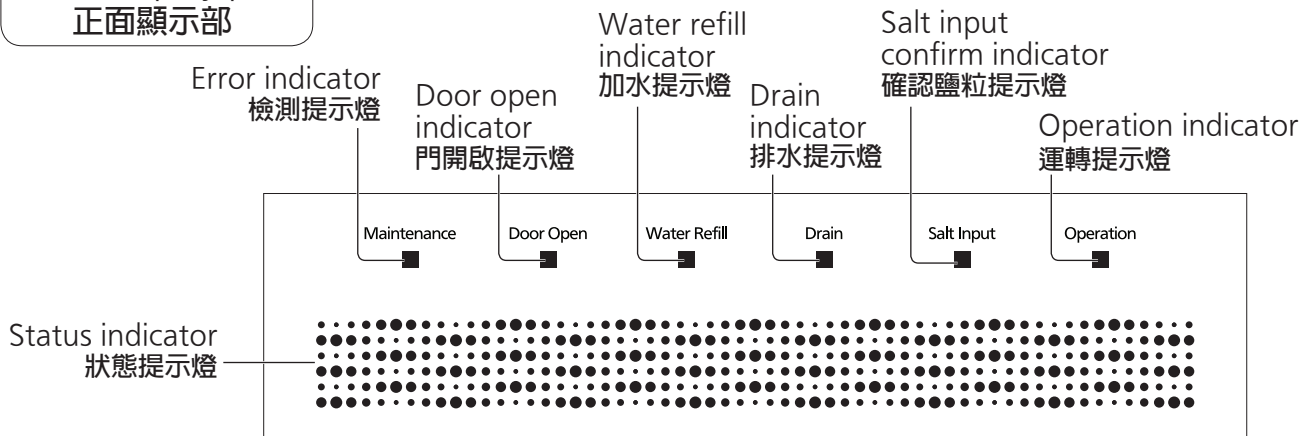

■ When the electrode reset indicator blinks or lights on
電極復位指示燈閃爍或亮起時

● Blinking: The electrode replacement time is approaching. The electrode reset indicator will become steady on after blinking for about one month.

閃爍：已經快到更換電極時間，閃爍約1個月後電極復位指示燈將會常亮。

→ Please replace the electrode unit. (Page 22~23)
請更換電極組件。（第22~23頁）

● Steady on: The product does not work.
常亮：無法運轉。

■ When the cleaning reset indicator lights on <About once a month>
清潔復位指示燈亮起時 <約1個月亮起>

→ Please perform maintenance.
請進行維護保養。

After the maintenance, install the dust filter, tray, pump assembly, anti-fungus assembly, and sterilization filter assembly (Pages 16~22) back to the main unit. After installation, press and hold  for about 3 seconds.

對集塵過濾網、水盤、泵組件、防霉組件、除菌過濾網組件進行維護保養（第16~22頁）後，安裝到主機上。安裝後請按  約3秒鐘。

● If you perform maintenance before the cleaning reset indicator lights on, press and hold  for about 3 seconds as well.

如果在清潔復位指示燈的亮起時間之前進行維護保養，也請按  約3秒鐘。

■ When the error indicator lights on
檢測提示燈亮起時

→ Please check the error code displayed on the digital display. (Page 27)
請確認數字顯示屏的異常碼。（第27頁）

■ When the door open indicator lights on
門開啟提示燈亮起時

→ The front panel is open or not closed properly, and the product cannot operate at this time.
提示前面板未關閉或未關閉好，此時產品將無法運轉。

■ When the water refill indicator lights on
加水提示燈亮起時

→ There is little or no water in the tray, and the product cannot operate at this time.
提示水盤中少水或無水，此時產品將無法運轉。

■ Status indicator
狀態提示燈

Lighting on from the center to both sides:
Normal operation is in progress.
從中央往兩端亮起：運轉中



Blinking on both ends at the same time:
Preparatory operation is in progress.
兩端同時閃爍：準備運轉中

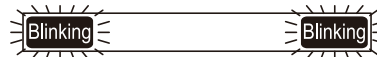

Blinking at the center: Cleaning operation is in progress.
中央閃爍：清潔運轉中



Blinking alternately at two positions: Drying operation of the sterilization filter is in progress.
2處交替閃爍：除菌過濾網乾燥運轉中



■ When the drain indicator lights on
排水提示燈亮起時

→ The drain tank is full of water. Please empty the drain tank and install it back; otherwise the product cannot operate.
提示排水水箱已滿水，請倒掉水並把排水水箱重新裝入，否則產品將無法運轉。

■ When the salt input confirm indicator lights on
確認鹽粒提示燈亮起時

→ One salt tablet should be added. After adding, press the salt input confirm button on the control panel; otherwise the product cannot operate.

提示加入1粒鹽粒，加入後按下操作面板上的確認鹽粒按鈕，否則產品將無法運轉。

■ When the operation indicator lights on
運轉提示燈亮起時

→ The product is operating normally.
提示產品正在正常運轉。

OPERATION

使用方法

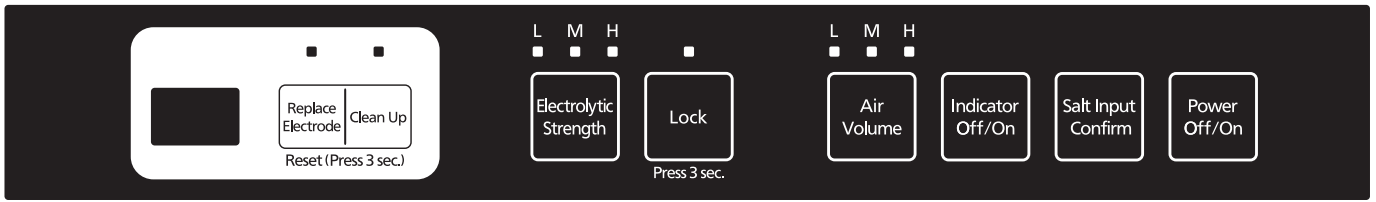

Preparations: ① Before setup, fill in the date of first use on the "(Check records)" label
 準備： on the inner surface of the front panel.
 在設置之前請在前面板內側的“(點檢記錄)”標籤上填寫使用開始時間。

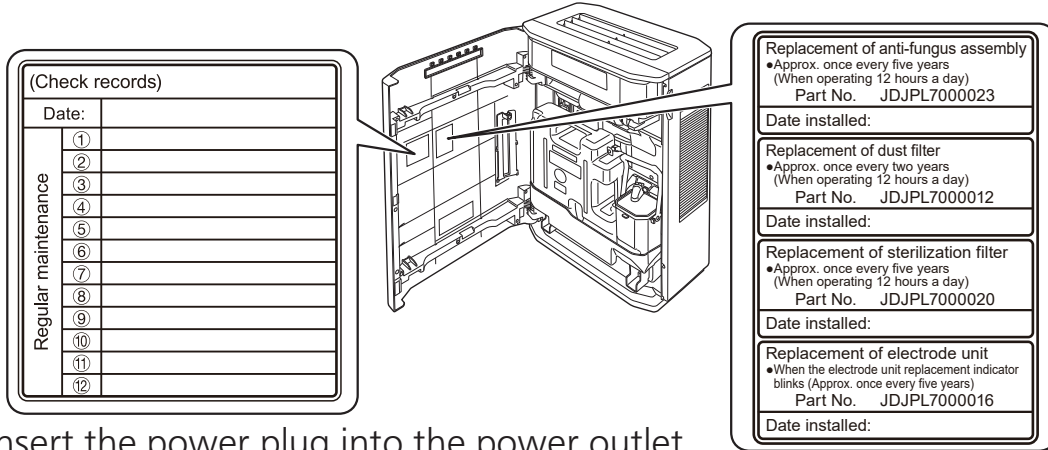

- ② Insert the power plug into the power outlet.
將電源插頭插入電源插座。
- ③ Supply/drain water. (→“Water supply/drainage method” on Page 13~15)
進行供水/排水作業。(→第13~15頁“供水/排水方法”)

OPERATION
使用方法

1 Start to operate. 開始運轉。



(The operation indicator lights on)
(運轉提示燈亮起)

- The product enters preparatory operation in about 20 seconds after the button is pressed. (When the brightness switch is turned on, the status indicator starts blinking on both ends at the same time.)
按下後約20秒鐘為預備運轉時間。
(亮度開關開啟時，狀態提示燈的兩端同時閃爍)
 - The product does not blow out air during preparatory operation.
預備運轉期間不向外吹風。
- After the preparatory operation is completed, the product starts to operate.
預備運轉結束後，開始運轉。

2 Select the operation mode. 選擇運轉模式。



Press this button to switch level by level.
按此按鈕逐級進行切換。



(The indicator lights on)
(指示燈亮起)

- The air volume can be set in 3 levels.
風量可按3級進行設定。

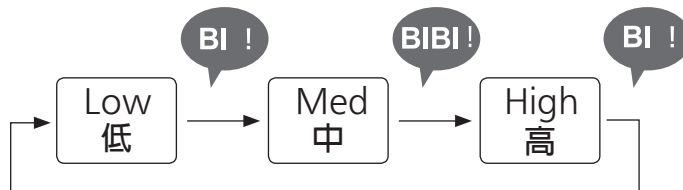

- The factory setting is "High" mode.
出廠設置為“高”模式。
- It can be set during preparatory operation.
也可在預備運轉期間進行設定。

OPERATION

使用方法

3 Stop operating. 停止運轉。



(The indicator lights off)
(指示燈熄滅)

- The product continues to blow air for about 10 seconds after the button is pressed. (The purpose is to drain the hypochlorous acid accumulated in the main unit.)
按下後繼續吹風約10秒鐘。
(目的是為了排出主機內積聚的次亞鹽素酸)

Notice 提示事項

- If the front panel is opened during operation, the product will sound "BIBIBIBI!" and pause the operation. While the front panel is open, the door open indicator keeps blinking. The product enters preparatory operation in about 20 seconds after the front panel is closed. After the preparatory operation is completed, the product returns to the operation mode before the front panel is opened.

如在運轉期間打開前面板，將會發出“BIBIBIBI!”聲，並暫停運轉。在前面板打開期間，門開啟提示燈閃爍。關閉前面板後約20秒鐘，進行預備運轉。預備運轉結束後，恢復到前面板打開前的運轉模式。

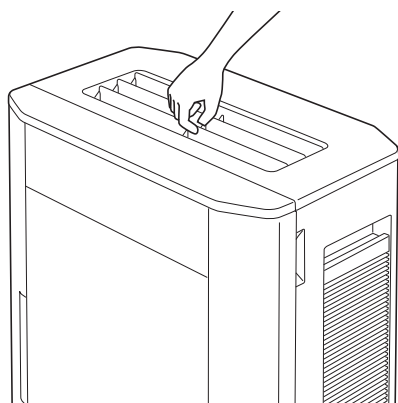

Adjusting the wind direction 調整風向

You can change the wind direction by adjusting the louver by hand.
可通過用手撥動導風板來改變風向。

- The louver is adjustable in 3 levels.
導風板可進行3級調整。

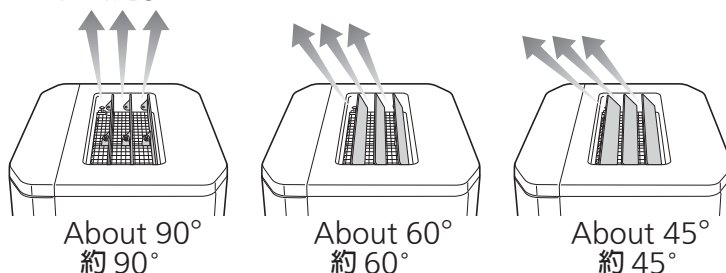

Switching the brightness 切換亮度

Indicator
Off/On

If you are not satisfied with the brightness, press this button to turn off the status indicator. Then other indicators will dim.

對亮度不滿意時，按下此按鍵，可關閉狀態提示燈，其他指示燈的亮度變暗。

Locking the operation 鎖定操作

Lock

(Press the button for about 3 seconds)
(長按約3秒鐘)

(The indicator lights on)
(指示燈亮起)

The purpose is to prevent misoperation.
防止誤操作。

With this setting, if you press any button other than ,

設定後如按  以外的按鈕，

the product will sound "BI-BI" and operation is not possible.
將會發出“BI-BI”的警告音，不能進行操作。

- To cancel this mode
希望取消模式時
Press the button for about 3 seconds again.
(The indicator lights off)
再次長按約3秒鐘。(指示燈熄滅)

Selecting the electrolytic strength 選擇電解強度

Electrolytic
Strength

You can select the amount of the hypochlorous acid to be produced.

可以選擇次亞鹽素酸的產生量。

Press this button to switch level by level.

按此按鈕逐級進行切換。



- If you are not satisfied with the smell in the room, or if you want to improve the sterilization effect, select "H". (You may smell some chlorine during electrolysis.) (The factory setting is "M".)
對房間內的氣味不滿意時，或希望提高滅菌效果時，請選擇“高”。(電解時會聞到一定的氯味。)(出廠設置為“中”。)

OPERATION

使用方法

Cleaning operation (Auto) 清潔運轉 (自動)

- In order to keep its inside clean, the product will automatically perform the cleaning operation regularly (for approximately 4 minutes every 4 hours) when it is idle.

為了保持產品內部清潔，本產品會在停止運轉時定期自動進行清潔運轉(約每4小時運轉4分鐘)。

(A gentle breeze may blow out during the cleaning operation.)

(清潔運轉時會有微風吹出)



(The status indicator is blinking at the center.)

(狀態提示燈的中央閃爍)

Requirements 要求

- Please check that there is water in the water supply tank as the cleaning operation is not possible without water.
供水水箱中無水時，不進行清潔運轉，因此請檢查供水水箱是否有水。
- Do not disconnect the power plug since automatic control is active when the product is idle.
停止運轉期間進行自動控制，因此請勿拔下電源插頭。
- During the idle period, the product will no longer drain or clean when the drain tank is full.
停止運轉期間，排水水箱滿水時，不再排水清潔。

WATER SUPPLY/DRAINAGE METHOD 供水/排水方法

- When the water supply tank runs out of water, the product will sound "BIBI" 5 times and stop operating. (The water refill indicator and drain indicator are blinking.)

供水水箱中的水排盡時，將會響起5次“BIBI”聲，停止運轉。(加水提示燈、排水提示燈閃爍)

Notice 提示事項

- If you remove the water supply tank still with water, the drain indicator will blink after about 5 seconds. After the drain indicator blinks, please empty the drain tank; otherwise the product cannot operate.

供水水箱內還有水時，如卸下供水水箱，約5秒鐘後排水提示燈閃爍。排水提示燈閃爍後，請倒掉排水水箱的水，否則產品無法運轉。



CAUTION 注意



- Make sure that no water spills out when carrying the water supply tank, drain tank or tray. If any water spills out, wipe it off immediately.
在搬運供水水箱，排水水箱，水盤時，請確保在水不會灑出的狀態下搬運。如果有水灑出，請及時擦掉。

(If water spills out on the floor, etc., discoloration or deterioration may be caused due to the bleaching effect of hypochlorous acid.)

(水如果灑到地板等上面，會由於次亞鹽素酸的漂白作用而導致變色或變質。)

- When draining the water, turn on the tap to flush the sink clean.
排水處理時，請同時打開自來水，將水槽沖洗乾淨。

(Otherwise, the sink and water pipe may oxidize to form rust.)

(否則有可能導致水槽和水管管道等氧化(生鏽)。)

WATER SUPPLY/DRAINAGE METHOD

供水/排水方法

■ Make sure to use the tap water.

請務必使用自來水

(Because chlorination has been performed generally for tap water and hence the miscellaneous bacterium is difficult to breed.)
(因為一般都經過了氯化處理，雜菌難以繁殖。)

● Do not use the following water.
請勿使用以下各種水。

• Hot water above 40 °C, or water mixed with detergents.

40 °C 以上的熱水或加入洗滌劑的水

(Otherwise, the tank deformation may be caused.)
(可能導致變形或發生故障。)

• Water mixed with chemicals, air fresheners and essential oils.

加入化學藥品、芳香劑、精油等的水

(Otherwise, the tank may be damaged and the furniture, appliances, etc. may be wet. →Page 6)
(水箱破損後可能導致傢俱家電等受潮受損→第6頁)

• Water from a water purifier, alkaline ion water, mineral water

淨水器的水或鹼離子水、礦物質水

(Otherwise, mildew and miscellaneous bacterium may multiply fast.)
(否則可能導致霉菌及雜菌大量繁殖。)

• Well water

井水

(Otherwise, mildew and miscellaneous bacterium breeding may be caused, discoloration may occur, and the replacement cycle of the electrode unit may be shortened.)
(否則可能導致霉菌及雜菌大量繁殖、變色、電極組件的更換時間提前。)

■ With a full tank of water supports continuous operation of up to 9.6 hours.

一滿箱水可持續運轉最長時間約9.6小時

(When the air volume is set to "H", the indoor temperature is 20 °C and the relative humidity is 30%)

(風量“高”運轉且室內溫度為20 °C、濕度為30%時。)

Remove the tank 取出水箱

1 Remove the water supply tank and drain tank from main unit. 從主機上取出供水水箱和排水水箱。

● Be sure to disconnect the power plug when adding water.
加水時，請務必拔下電源插頭。

① Open the front panel.
打開前面板。

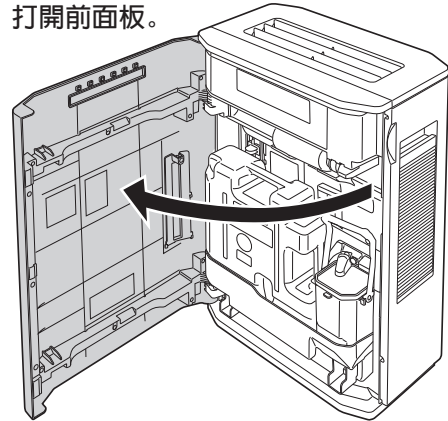

② Remove the water supply tank and drain tank.
取出供水水箱和排水水箱。

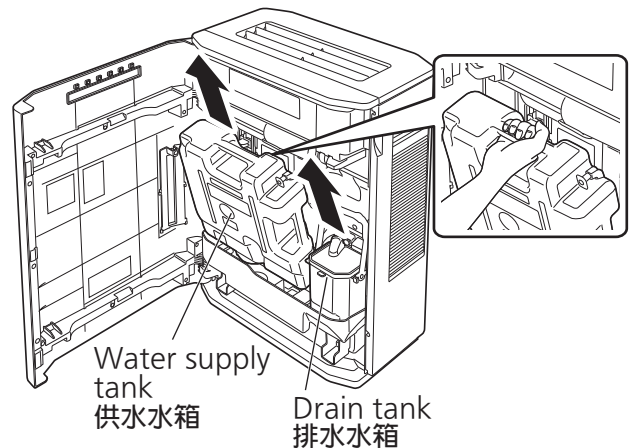

Take it out carefully to avoid water spilling.
請小心取出，注意避免水灑出。

③ Open the tank cover of the water supply tank.
打開供水水箱的水箱蓋。

tank cover
水箱蓋

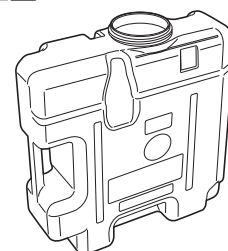

WATER SUPPLY/DRAINAGE METHOD

供水/排水方法

Water supply/drainage and reassembly 進行供水/排水並裝回主機

2 Add water to the water supply tank, empty the drain tank and install it back to the main unit.
向供水水箱裡加水，倒掉排水水箱的水，裝回主機。

- ① Add water to the water supply tank and screw the tank cover tightly.
向供水水箱裡加水，擰緊水箱蓋。
 - Add water with a kettle, etc. if the tank cannot be put into the sink.
加水時如果水箱無法放入水槽，請用水壺等加水。

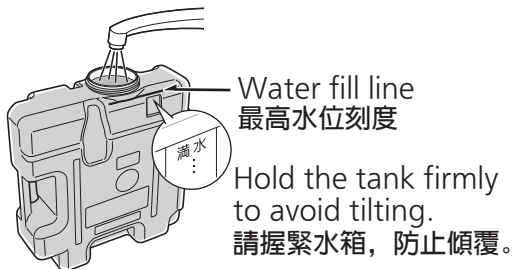

- ② Empty the drain tank.
倒掉排水水箱裡的水。



Meanwhile, turn on the tap to flush the sink clean.
請同時打開自來水，將水槽沖洗乾淨。

- ③ Install the water supply tank and drain tank back to the main unit.
將供水水箱和排水水箱裝回主機。
Install them back to the original position with the tank cover facing down and the mark facing you.
請將水箱蓋朝下，刻印朝向操作者裝回原處。

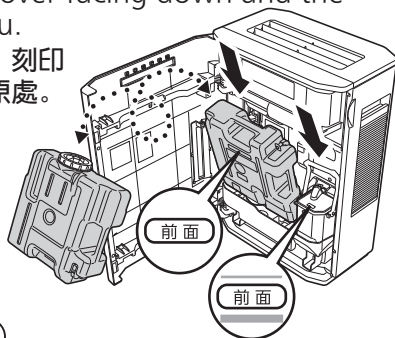

Notice 提示事項

- Check that the tray and drain tank are already installed back to the innermost of the main unit. Otherwise, the sensor may not function normally or water may leak out of the product.
請確認水盤和排水水箱已經裝回到主機的最裡側。否則可能會引起感應器檢測異常或導致產品漏水。

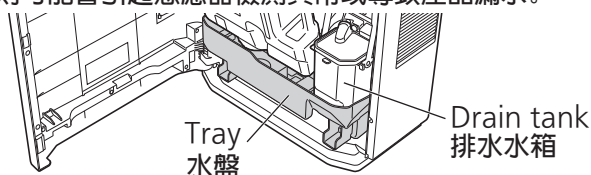

Adding a salt tablet 投入鹽粒

3 Add one salt tablet in the tray and press the salt input confirm button.
向水盤內裡投入1粒鹽粒，按下確認按鈕。

- ① Take out one salt tablet from the salt container inside the main unit.
從主機內的鹽瓶中取出1粒鹽粒。

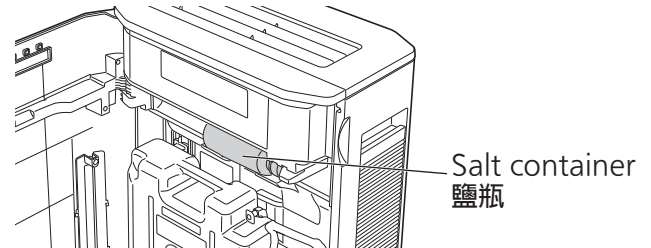

- ② Put one salt tablet into the salt inlet of the tray.
向水盤的鹽粒投入口投入1粒鹽粒。

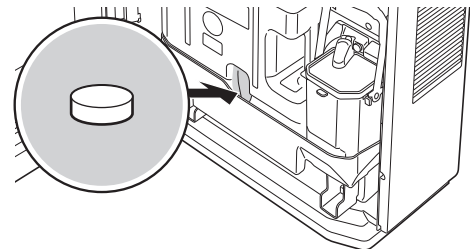

- Be sure to add one salt tablet in the tray each time when you add water.
加水時，務必向水盤投入1粒鹽粒。
 - If no salt tablet is added, the effect of hypochlorous acid may be weakened or even completely eliminated.
如不投入鹽粒，次亞鹽素酸的效果將會減弱甚至沒有效果。
- Be sure to use the supplied or optional salt tablet (Page 24).
請務必使用附屬品或自選配件(第24頁)的鹽粒。

- ③ Close the front panel.
關閉前面板。
 - Connect the power plug.
插入電源插頭。
(Wipe the water off power plug and your hands before connecting the power plug.)
(插入前，擦乾電源插頭以及手上沾有的水。)
- ④ Press the salt input confirm button.
按下確認鹽粒按鈕。



Notice 提示事項

- Be sure to close the front panel properly.
請務必關好前面板。
- Once the power plug is inserted into the power outlet, the product starts to drain water.
將電源插頭插入到電源插座後，產品開始進行排水處理。

MAINTENANCE

維護保養

Precautions before maintenance 維護保養前注意事項

- When using chemically treated cloth, be sure to follow the instructions carefully.
使用化學性抹布時，請按照其使用注意事項進行使用。
- Do not use the detergents shown below.
禁止使用如下所示的洗滌劑等。

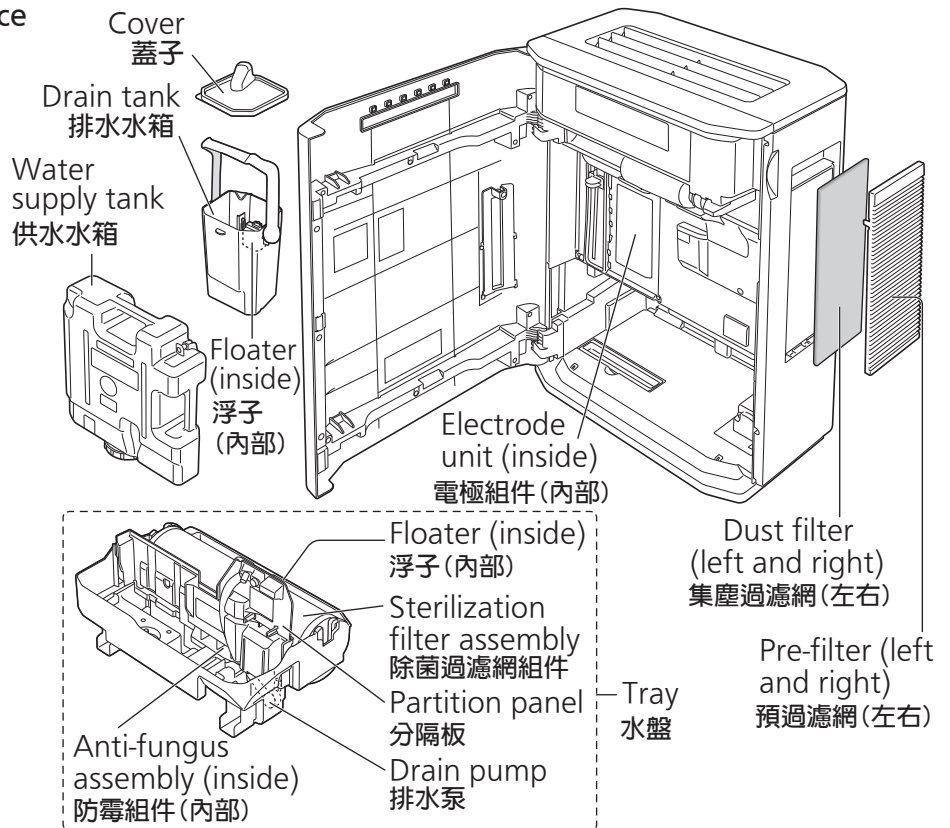

⚠ WARNING 警告



- Make sure to disconnect the power plug before cleaning the product.

維護保養產品前，請務必拔出電源插頭。

(Otherwise, the product might operate with the possibility of electric shock or injury.)

(否則產品可能會突然運轉，導致觸電或受傷。)



- Do not use acid detergents or citric acid.

禁止使用酸性洗滌劑或檸檬酸。

(Otherwise, toxic gas may be produced, which is harmful to your health.)

(否則可能產生有毒氣體，危害健康。)

Notice 提示事項

- Wipe the main unit clean with a well wrung-out soft cloth when you find it dirty. Wiping with a hard cloth may cause scratch the surface.
發現主機有髒漬時，請用擰乾的柔軟抹布擦拭。如果使用質地較硬的布用力擦拭，可能會劃傷表面。
- Do wipe the power plug with a dry cloth.
擦拭電源插頭時請務必使用乾布。
- As the degree of dirtiness varies with the water quality and operating environment, maintenance may be required even before the cleaning reset indicator lights on or before the specified time is reached, as long as there is an unpleasant odor or the water in the tank is reduced at a slower speed.
根據水質和使用環境情況，髒漬程度也不盡相同，因此即使在清潔復位指示燈亮起之前，或未達到規定期限，只要有臭味或水箱的水下降得慢時，也要進行維護保養。

MAINTENANCE

維護保養

	Electrode unit 電極組件	Dust filter 集塵過濾網	Sterilization filter 除菌過濾網	Anti-fungus assembly 防霉組件
User routine cleaning 用戶定期清潔	-	About once a month 約每月1次	About once a month 約每月1次	About once a month 約每月1次
Replacement cycle 定期更換	About 5 years 約5年	About 2 years 約2年	About 5 years 約5年	About 5 years 約5年

Please contact the dealer for purchase or replacement of the above accessories.
以上配件購買或更換請聯繫經銷商。

Cleaning frequency varies with water quality and operating environment.
清洗時間及次數應根據水質和使用環境情況調節。

Tank <Every day> 水箱 <每天>

Flush the water supply tank and drain tank clean.
沖洗供水水箱、排水水箱。

- Do not remove the floater.
請勿取下浮子。
(If the floater is not installed correctly, the product cannot operate and water may leak.)
(如未正確裝上將無法運轉，可能導致漏水。)
- If the floater is shifted:
浮子移位時的處理方法。
Fit both protrusions into the corresponding holes of appropriate sizes.
將突出部插入孔的適當大小的一端。

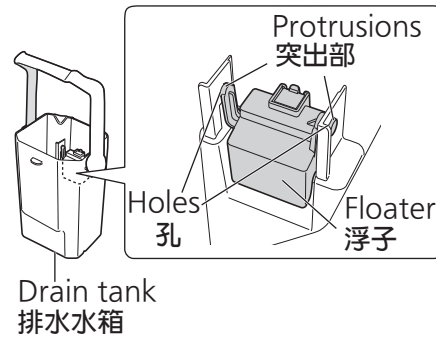

CAUTION 注意

- 

■ Make sure that no water spills out when carrying the water supply tank, drain tank or tray. If any water spills out, wipe it off immediately.
在搬運供水水箱，排水水箱，水盤時，請確保在水不會灑出的狀態下搬運。如果有水灑出，請及時擦掉。
(If water spills out on the floor, etc., discoloration or deterioration may be caused due to the bleaching effect of hypochlorous acid.)
(水如果灑到地板等上面，會由於次亞鹽素酸的漂白作用而導致變色或變質。)
- 

■ When draining the water, turn on the tap to flush the sink clean.
排水處理時，請同時打開自來水，將水槽沖洗乾淨。
(Otherwise, the sink and water pipe may oxidize to form rust.)
(否則有可能導致水槽和水管管道等氧化(生鏽)。)
- 

■ Do not clean the product with gasoline or other volatile mixture solvents, and avoid contacting with spray insecticides.
禁止使用汽油或其他揮發性混合溶劑擦拭產品，以及把殺蟲劑噴到產品上。
(Otherwise, the product may crack or short circuit with the possibility of injury, fire or electric shock.)
(否則產品可能會出現裂紋或短路，導致受傷、火災或觸電。)

MAINTENANCE

維護保養

Pre-filter <About once a month> 預過濾網 <約每月1次>

1 Remove the pre-filter and the dust filter.

卸下預過濾網和集塵過濾網。

Remove the pre-filter and the dust filter in turn.

依次卸下預過濾網和集塵過濾網。

① Pull the top of the pre-filter forward to remove the pre-filter.

將預過濾網前端向前拉，拆下預過濾網。

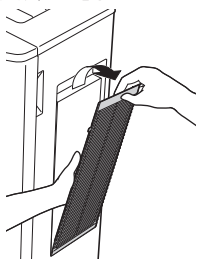

② Remove the dust filter.

拆下集塵過濾網。

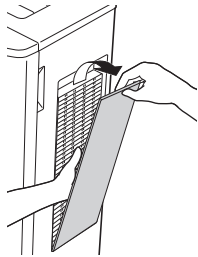

2 Remove the dirt with a vacuum cleaner, etc.

用吸塵器等除污。

Dust filter
集塵過濾網



Pre-filter
預過濾網

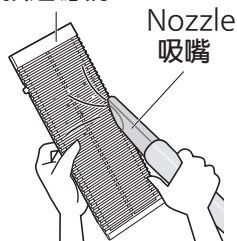

● Do not wash the dust filter with water.
請勿對集塵過濾網進行水洗。

● As the degree of dirtiness varies with the operating environment, maintenance may be required even before the specified time is reached, as long as there is an unpleasant odor or the water in the tank is reduced at a slower speed.

根據使用環境情況，髒污程度也不盡相同，因此即使未達到規定期限，只要有臭味或水箱的水下降得慢時，也要進行維護保養。

Dust filter <About once a month> 集塵過濾網 <約每月1次>

● Do not operate the product with the dust filter or pre-filter removed. (Otherwise, dust may build up inside the main unit, thus resulting in malfunction.)

請勿在拆下集塵過濾網或預過濾網的情況下運轉。
(否則會導致主機內部灰塵積聚，引起故障。)

3 Install the pre-filter and dust filter back.

裝回預過濾網和集塵過濾網。

Install the dust filter and pre-filter back in turn.

依次安裝集塵過濾網和預過濾網。

① Install the dust filter.

安裝集塵過濾網。

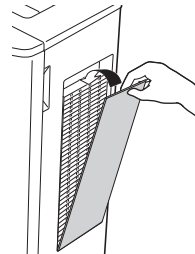

② Insert the protrusions (two) of the pre-filter into the holes (two) on the main unit.

將預過濾網的突出部(2處)插到主機的孔(2處)裡。

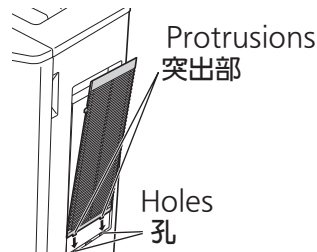

③ Push it in until it clicks into place.

推入直至發出“咔嗒”聲。

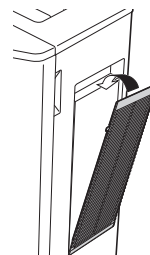

Reference replacement cycle of the dust filter

更換集塵過濾網的參考時間

Replacement cycle 更換期限	About once* every 2 years 約2年1次
Conditions 條件	The product runs 12 hours a day. 每天12小時運轉時

(Optional accessories: Page 24)
(自選配件: 第24頁)

※ As the degree of dirtiness varies with the operating environment, replacement may be required even within 2 years if there is still an unpleasant odor or the water in the tank is reduced at a slower speed upon maintenance.

根據使用環境情況，髒污程度也不盡相同，如在維護保養後仍發出臭味或水箱的水下降得慢時，即使在2年以內也請更換。

● After replacement, fill in the replacement date, etc. on the "(Check records)" label on the inner surface of the front panel.
更換後請在前面板內側的“(點檢記錄)”標籤上填寫更換日期等。

MAINTENANCE

維護保養

Tray · Partition panel <About once a month> 水盤 · 分隔板 <約每月1次>

1 Remove the tray from the main unit. 從主機上取出水盤。

- ① Slide up the slider latch to the top.※1
將把手移動到最上方。
- ② Remove the tray.
把水盤取出。

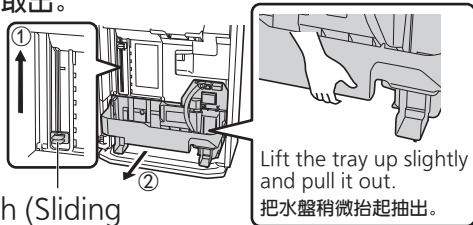

Slider latch (Sliding while pinching.) 把手(捏住同時移動)

※1 You cannot take the tray out without lifting the slider latch (electrode unit). Therefore, be sure to check that the electrode unit is lifted before taking the tray out.
如不抬起把手(電極組件)就無法取出水盤。務必在確認電極組件已經升起後再取出水盤。

2 Remove the partition panel, sterilization filter assembly and anti-fungus assembly from the tray, and clean them one by one. 從水盤上拆下分隔板、除菌過濾網組件、防霉組件，並分別進行維護保養。

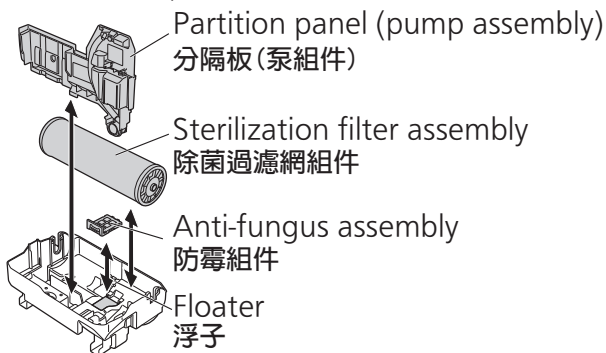

■ Do not remove the floater (expanded polystyrene). (The product may not work if they are not installed correctly.)
請勿取下浮子(發泡聚苯乙烯)。(如未正確裝上會導致不運轉。)

■ If the floater is shifted:
Put the protrusions under the buckle.
浮子移位時的處理方法：將突出部放入別扣的下方

- ① While pressing them in the arrow direction, 一邊沿箭頭方向按，
- ② insert them into the holes. 一邊插進孔。

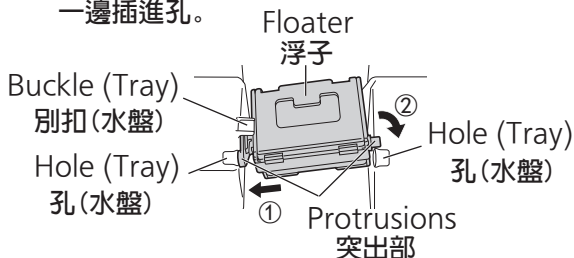

3 Empty the tray and flush thoroughly. 倒掉水盤裡的水，進行沖洗。

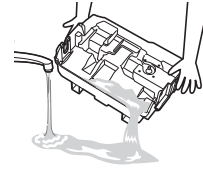

- Remove the incrustation and any other dirt with a soft cloth moistened in water.
使用浸過水的軟布去除水垢等污漬。
- Wipe the dirt with a swab, or use a toothbrush to scrub it.
用棉棒或牙刷等去除細微處的污垢。

4 Install the partition panel, sterilization filter assembly and anti-fungus assembly onto the tray. 將分隔板、除菌過濾網組件、防霉組件安裝到水盤上。

- ① Place the anti-fungus assembly horizontally into the recess.
防霉組件水平放入凹部。
- ② Insert the partition panel along the groove.
分隔板順著溝槽插入。
- ③ Install the gear of the sterilization filter assembly into the recess of the tray.
除菌過濾網組件將齒輪裝到水盤的凹處。

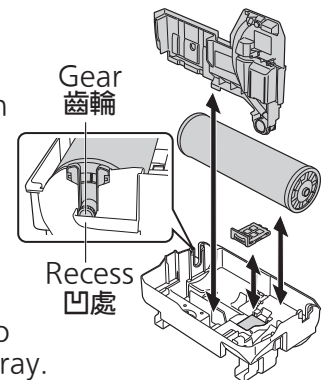

5 Install the tray back to the main unit. 將水盤裝回主機。

- ① Set slider latch at the top position.
確認把手在最上方。
- ② Install the tray.
裝上水盤。
- ③ Slide down the slider latch to the bottom.※2
將把手拉到最下方。

Slider latch (Sliding while pinching.)
把手(捏住同時移動)

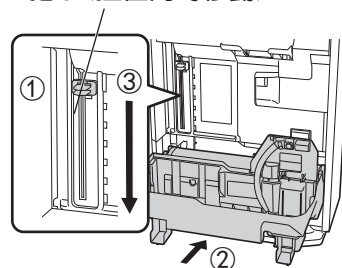

※2 You cannot close the front panel without pulling the slider latch to the bottom.
把手如不拉到最下方則無法關閉前面板。

MAINTENANCE

維護保養

Pump assembly <About once every 6 months>

泵組件 <約每6個月1次>

1 Remove the pump assembly from the partition panel.
從分隔板上拆下泵組件。

① Unscrew the hand screw and remove the coupler from the partition plate.
拆下手擰螺釘，從分隔板上拆下接頭。

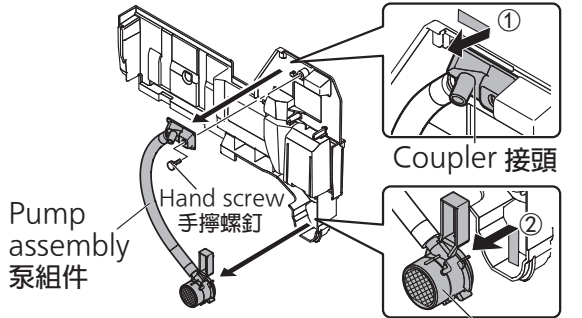

② Lift the drain pump up to pull it out.
將排水泵向上抬起抽出。

2 Remove the pump filter and impeller from the pump assembly.
從泵組件上拆下泵過濾網和葉輪。

Rotate the cover on the opposite side to the pump filter in the arrow direction (①) and remove the impeller.
按箭頭方向(①)轉動泵過濾網相反一側的蓋子，拆下葉輪。

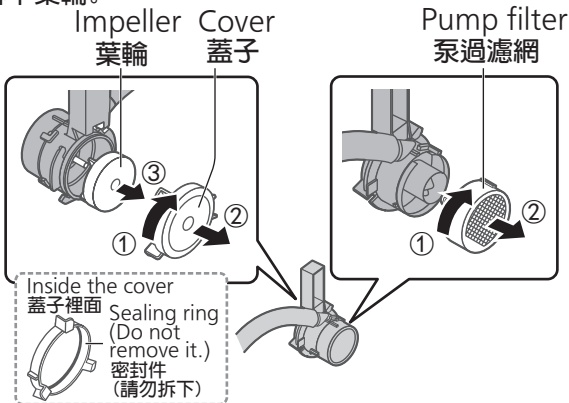

3 Wash it with water.
用水清洗。

- Do not remove the hose or the sealing ring.
軟管、密封件請勿拆下。
- Wipe the dirt off the pump filter with a cotton swab, or use a toothbrush to scrub it.
用棉棒和牙刷等清除泵過濾網等部位的髒漬。

Install the removed parts back properly; otherwise:
請將拆下的零件準備安裝上去，否則：

- The tank cannot supply water to the main unit anymore.
水箱的水不能再供應給主機。
- Water may leak out or the product may malfunction.
會導致漏水和故障。

Make sure that the sealing ring is installed correctly.
請確認密封件已正確安裝。

4 Install the pump filter and impeller onto the pump assembly.
將泵過濾網和葉輪安裝到泵組件上。

Install the pump filter, impeller and cover.
安裝泵過濾網和葉輪、蓋子。

(Align the pump filter and the cover with the respective positioning marks, and fasten the buckles (three).)
(將泵過濾網和蓋子分別對準定位標記，把別扣(3處)卡住)

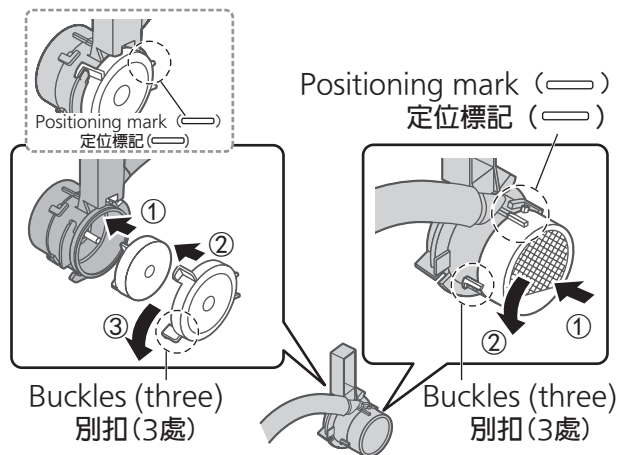

5 Install the pump assembly onto the partition plate.
將泵組件安裝到分隔板上。

Align the buckles (two) of the coupler with the notches and insert them in.
將接頭的別扣(2處)對準缺口部插入。
Buckles (two) 別扣(2處)

Install the hand screw onto the partition plate.
將手擰螺釘安裝到分隔板上。

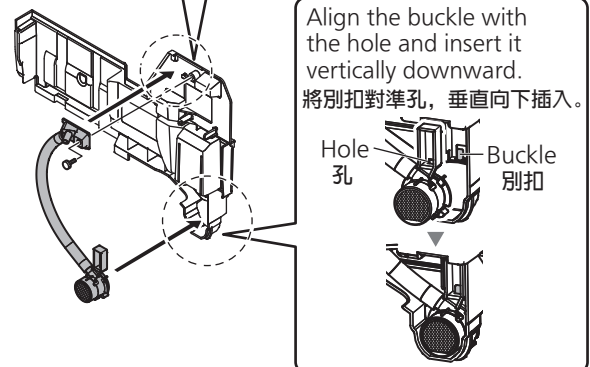
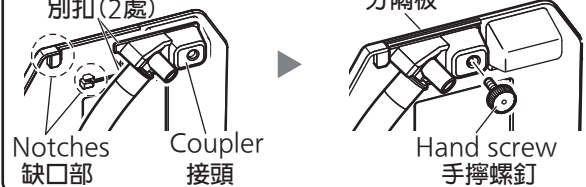

Suggested time—Cleaning frequency varies with water quality and operating environment. It is suggested to clean it at least about once every 6 months.

建議時間—清洗時間及次數應根據水質和使用環境情況調節，建議最少6個月清洗1次。

MAINTENANCE

維護保養

Anti-fungus assembly <About once a month> 防霉組件 <約每月1次>

Wash it with water.
用水清洗。

- Do not scrub it with a brush, nor disassemble it.
請勿用刷子刷洗或分解。
- Check whether the mesh of the anti-fungus assembly is damaged.
確認防霉組件的網是否破損。
→ If damaged, replace it.
如果破損，請更換。
- Check whether the housing of the anti-fungus assembly is dirty.
確認防霉組件的外殼是否有髒漬。
→ If dirty, wipe it clean with a soft cloth.
如果已有髒漬，請用柔軟的布擦拭乾淨。

Notice 提示事項

- The anti-fungus assembly may have powder sometimes. This is normal and not a problem with use.
防霉組件中有時會出現粉末，並不影響使用。
- The anti-fungus agent will be small along with the use. This is not a problem with the anti-fungus performance.
防霉劑伴隨使用會變小，並不影響防霉性能。
- The anti-fungus agent has its own special smell, harmless to humans.
防霉劑有其特殊的氣味，對人體無害。



Reference replacement cycle of the anti-fungus assembly 更換防霉組件的參考時間

Replacement cycle 更換期限	About once every 5 years 約5年1次
Conditions 條件	The product runs 12 hours a day. 每天12小時運轉時

(Optional accessories: Page 24)
(自選配件：第24頁)

- After replacement, fill in the replacement date, etc. on the "(Check records)" label on the inner surface of the front panel.
更換後請在前面板內側的“(點檢記錄)”標籤上填寫更換日期等。

Sterilization filter assembly <About once a month> 除菌過濾網組件 <約每月1次>

1 Disassemble 拆卸

Remove the filter plate and sterilization filter from the filter frame.
從過濾網框架上依次拆下過濾網壓板、除菌過濾網。

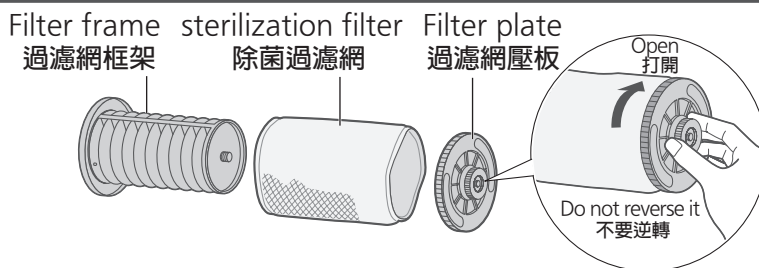

2 Wash 清洗

- Press and wash sterilization filter with clean/warm water.
用清水或溫水按壓清洗除菌過濾網
- Do not scrub it with a brush or wash it with a washing machine.
請勿用刷子刷洗或用洗衣機清洗。
- Do not dry it with a drier. (Doing this may cause shrinkage)
請勿使用乾燥機乾燥。(可能導致縮小)
- Wash the filter frame and filter plate with water
用水清洗過濾網框架和過濾網壓板。



3 Install 安裝

- ① Insert the sterilization filter into the filter frame.
將除菌過濾網插入過濾網框架。
 - ② Install the filter plate onto the filter frame.
將過濾網壓板安裝到過濾網框架上。
- Do not leave a gap between the sterilization filter and the filter plate as well as the filter frame, nor press the round parts of both ends.
(Otherwise, performance degradation may be caused.)
請勿在除菌過濾網和過濾網壓板及過濾網框架之間留下空隙，或壓住兩端的圓形部分。
(否則會導致性能下降)

MAINTENANCE

維護保養

Reference replacement cycle of the sterilization filter

更換除菌過濾網的參考時間

Replacement cycle 更換期限	About once every 5 years* 約5年1次
Conditions 條件	The product runs 12 hours a day. 每天12小時運轉時

(Optional accessories: Page 24)
(自選配件: 第24頁)

※ As the degree of dirtiness varies with the water quality and operating environment, replacement may be required even within 5 years if there is still an unpleasant odor or the water in the tank is reduced at a slower speed upon maintenance.

根據水質和使用環境情況，髒漬程度也不盡相同，如維護保養後仍發出臭味或水箱的水下降得慢，即使在5年以內也請更換。

● Please dispose of the used sterilization filter as non-combustible garbage. However, do not discard the filter frame and filter plate.

廢棄除菌過濾網時，請將其作為非可燃垃圾處理。但請勿丟棄過濾網框架和過濾網壓板。

● After replacement, fill in the replacement date, etc. on the "(Check records)" label on the inner surface of the front panel.

更換後請在前面板內側的“(點檢記錄)”標籤上填寫更換日期等。

When replacing the electrode unit

更換電極組件時

When the electrode reset indicator blinks

當電極復位指示燈閃爍時

● When the electrode reset indicator blinks, replace the electrode unit.

當電極復位指示燈閃爍時，請予以更換。

● The electrode reset indicator will become steady on after blinking for about one month. (When the electrode reset indicator becomes steady on, the product cannot operate.)

閃爍約1個月後電極復位指示燈將會常亮。

(當電極復位指示燈常亮時，將無法運轉)

● About once every 5 years. (In the case that the product runs 12 hours a day.)

約5年1次。(每天12小時運轉時)

● The replacement cycle may vary with the water quality and operating environment.

根據水質和使用環境情況，更換時間也會有所不同。

● After replacement, fill in the replacement date, etc. on the "(Check records)" label on the inner surface of the front panel.

更換後請在前面板內側的“(點檢記錄)”標籤上填寫更換日期等。

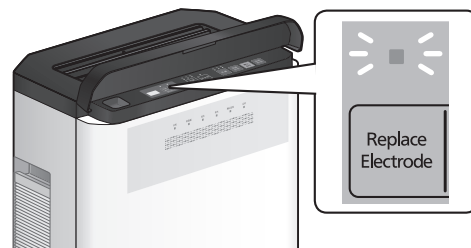

Requirements

要求

● Be sure to use the electrode unit dedicated for this product. (See "Optional accessories" on Page 24.)
請務必使用本機專用的電極組件(“自選配件”第24頁)。

● When lifting up or pressing down the electrode unit, please pinch the slider latch to move it.
抬起或按下電極組件時，請捏住把手移動。

MAINTENANCE

維護保養

Removing/Installing the electrode unit 電極組件的拆卸/安裝方法

■ Removing 拆卸方法

- ① Disconnect the power plug.
拔下電源插頭。
- ② Open the front panel.
打開前面板。
- ③ Take the water supply tank and drain tank out.
取出供水水箱和排水水箱。
- ④ Lift the slider latch up and place the electrode unit into the main unit.
抬起把手，將電極組件放到主機內部。
- ⑤ Remove the tray from the main unit.
從主機上取出水盤。
- ⑥ Press the slider latch down and take the electrode unit out from the main unit.
按下把手，從主機內部取出電極組件。

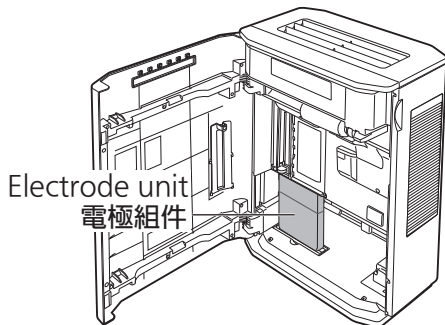

- ⑦ Remove the housing of the electrode unit.
拆下電極組件的外罩。

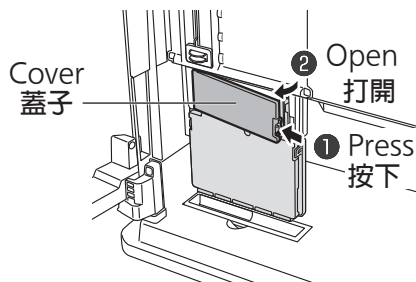

- ⑧ Remove the connector.
拆下連接器。

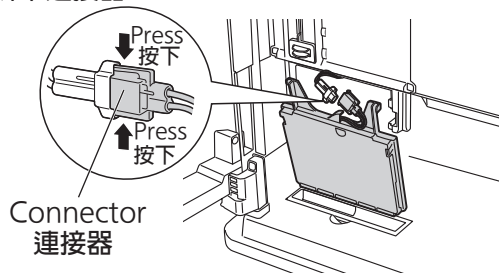

■ Installing 安裝方法

- ① Install the connector of the new electrode unit onto the main unit.
安裝新的電極組件的連接器，安裝到主機上。
Insert the protrusions (two) into the recesses (two).
將突出部 (2處) 嵌入凹面 (2處)。

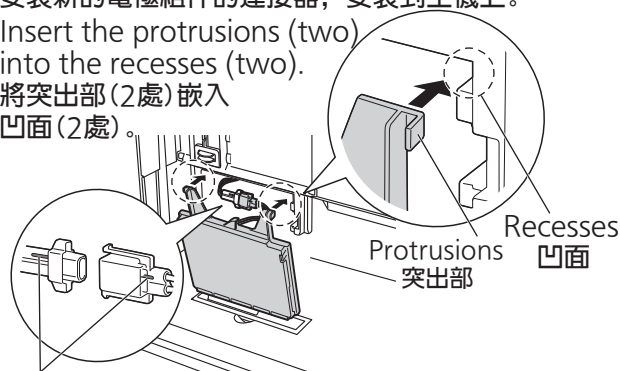

Align with the direction of the line
對準線的方向

- ② Install the housing onto the electrode unit.
將外罩安裝到電極組件上。

① Align the buckles with the holes.
將別扣對準孔

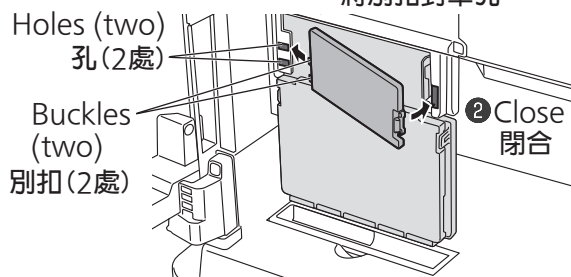

Insert the housing completely to the end.
將外罩切實嵌入到底。

(If not installed securely, the housing may fall off when you lift the slider latch.)
(如未安裝牢靠，抬起把手時有可能造成外罩脫落。)

- ③ Lift the slider latch up and place the electrode unit into the main unit.
抬起把手，將電極組件放到主機內部。
- ④ Install the tray back to the main unit.
將水盤裝回主機。
- ⑤ Pull the slider latch down.
將把手拉到下方。
- ⑥ Install the water supply tank and drain tank back to the main unit.
將供水水箱和排水水箱裝回主機。
- ⑦ Insert the power plug into the power outlet, and press and hold **Replace Electrode** for about 3 seconds.
將電源插頭插入電源插座，按 **Replace Electrode** 約3秒鐘。
- ⑧ Close the front panel.
關閉前面板。

Disposing of the electrode unit 關於電極組件的廢棄

- The electrode unit is a mixture of plastic and metal. Please dispose of it according to your local garbage classification rules.
電極組件是塑膠與金屬的混合物，請遵照所居住地區的垃圾分類方法進行廢棄。



MAINTENANCE

維護保養

When idle for a long time
長期間置時

- ① Disconnect the power plug.
拔下電源插頭。
- ② Empty the water supply tank, drain tank and tray, and clean the product.
倒掉供水水箱、排水水箱、水盤裡的水，並對產品進行維護保養。
- ③ Wipe each part dry and install them back to the main unit. The water refill indicator, drain indicator and salt input confirm indicator will blink.
將各部位的水完全擦乾之後再裝回主機，加水提示燈、排水提示燈和確認鹽粒提示燈閃爍。
- ④ Insert the power plug into the power outlet to enter drying operation of the sterilization filter.
(To prevent mildew and miscellaneous bacterium breeding)
將電源插頭插入電源插座，進行除菌過濾網乾燥運轉。(為防止發霉和產生雜菌)

Drying operation of the sterilization filter
除菌過濾網乾燥運轉

Press and hold both  and  for about 2 seconds.

同時按住  和  約2秒鐘。

The product will start the drying operation of the sterilization filter in the [H] mode.
在[高]運轉下開始除菌過濾網乾燥運轉。
It will stop automatically after about 2 hours.
約2個小時後自動停止。

To cancel it halfway, press and hold these two buttons for about 2 seconds again.
中途如需解除時，再次按約2秒鐘。

Notice 提示事項

If the drying operation is canceled halfway, the sterilization filter may not be completely dried.
如在中途解除除菌過濾網乾燥運轉，可能無法充分乾燥。





(The status indicator blinks alternately at two positions.)
(狀態提示燈的2處位置交替閃爍)

- ⑤ After the operation is stopped, disconnect the power plug and cover the main unit with a plastic bag or the like.
停止運轉後，拔下電源插頭，用塑膠袋等蓋上主機。
- ⑥ Store the product in a dry, level and stable place in an upright position.
請在乾爽、水平、穩定的場所立起來保存。

OPTIONAL ACCESSORIES

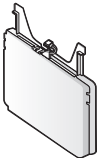
自選配件

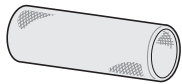
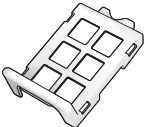



<p>● Replacement salt tablets 更換用鹽粒</p>  <p>Part No.: 型號: F-ZPL10Z</p>	<p>● Replacement electrode unit 更換用電極組件</p>  <p>Part No.: 型號: JDJPL7000016</p>	<p>● Replacement dust filter (2 pieces) 更換用集塵過濾網 (2片裝)</p>  <p>Part No.: 型號: JDJPL7000012</p>	<p>● Replacement sterilization filter 更換用除菌過濾網</p>  <p>Not include filter plate and filter frame. 不含過濾網框架和過濾網壓板。 Part No.: 型號: JDJPL7000020</p>	<p>● Replacement anti-fungus assembly 更換用防霉組件</p>  <p>Part No.: 型號: JDJPL7000023</p>
---	---	--	---	---

Please contact the dealer for purchase or replacement of the above accessories.
以上配件購買或更換請聯繫經銷商。

TROUBLESHOOTING



故障排除

If a problem is encountered, please investigate it by going through the following items. If the problem still persists, please disconnect the power plug and contact the dealer for repair. 首先請確認以下內容，執行此操作後仍無法修復時，請拔下電源插頭，並聯繫經銷商進行檢查、維修。

Possible situation 可能發生的狀況	Please confirm the following 請確認以下內容
① The air volume is small. 出風量少	<ul style="list-style-type: none"> ● Is the pre-filter or the dust filter clogged with dust or the like? 預過濾網、集塵過濾網(進風口)是否被灰塵等堵塞? → Clean the filter. (Page 18) 請消除堵塞。(第18頁) ● Is there incrustation or dust accumulated on the sterilization filter assembly? 除菌過濾網組件上是否附有水垢和灰塵? → Remove the incrustation and dust. (Page 21) 請清除水垢和灰塵。(第21頁)
② No air is blown out. 不吹風	<ul style="list-style-type: none"> ● Have 20 seconds elapsed after  is pressed? 按下  後是否等了20秒鐘? → The product enters preparatory operation in about 20 seconds after  is pressed. (Page 12) 按下  後約20秒鐘為預備運轉時間。(第12頁) If no air is blown out even after 20 seconds have elapsed, contact the dealer. 即使等上20秒鐘仍完全不吹風時，請聯繫經銷商。 ● Is the salt input confirm indicator blinking? 確認鹽粒提示燈是否在閃爍? → Make sure that you have added one tablet of salt into the tray and then pressed the salt input confirm button. (Page 15) 確認已向水盤內放入1粒鹽粒後再按確認鹽粒按鈕。(第15頁) ● Is the door open indicator blinking? 門開啟提示燈是否在閃爍? → Make sure that the front panel is closed. (Pages 12 and 15) 請確認已關好前面板。(第12和15頁)
③ Chlorine is smelt. 發出氯(消毒)的氣味	<ul style="list-style-type: none"> ● That is because hypochlorous acid decomposes dirt and odor. 因為次亞鹽素酸分解了污垢和臭氣。 → If you do not like the smell of chlorine, adjust the electrolysis strength to "L". (Page 12) 不喜歡氯(消毒)的氣味時請將電解強度調到“低”。(第12頁)
④ The air coming out from the air outlet smells bad. 出風口吹出的風有臭味	<ul style="list-style-type: none"> ● Are the tray and sterilization filter dirty, or are you not using new tap water? 水盤、除菌過濾網是否有髒漬，或未使用新的自來水? → Clean the tray, sterilization filter and water supply tank (Pages 17, 19 and 21) and refill with new tap water. (Page 15) 請進行水盤、除菌過濾網、供水水箱的維護保養(第17、19和21頁)，換上新的自來水。(第15頁)
⑤ Water in the water supply tank dose not decrease. 供水水箱水量不減少	<ul style="list-style-type: none"> ● Is the pre-filter or the dust filter (air inlet) clogged with dust or the like? 預過濾網、集塵過濾網(進風口)是否被灰塵等堵塞? → Clean the filter. (Page 18) 請消除堵塞。(第18頁) ● Is there incrustation or dust accumulated on the sterilization filter assembly? 除菌過濾網組件上是否附有水垢和灰塵? → Remove the incrustation and dust. (Page 21) 請清除水垢和灰塵。(第21頁)

TROUBLESHOOTING

故障排除

Possible situation 可能發生的狀況	Please confirm the following 請確認以下內容
<p>⑤ Water in the water supply tank dose not decrease. 供水水箱水量不減少</p>	<ul style="list-style-type: none"> ● Is the humidity high or the room temperature low? 是否濕度高或室溫低? →When the humidity is high or it's cold, the water in the water supply tank decreases slowly. 濕度高時或寒冷的日子裡，供水水箱裡的水減少得慢。 ● Is the front panel closed? 是否關閉好了前面板? →Be sure to close the front panel properly. (Pages 12 and 15) 請務必關閉好前面板。(第12和15頁)
<p>⑥ There is still water remaining in the drain tank even after you have emptied the drain tank and installed it back. 倒掉排水水箱裡的水並裝回去，可排水水箱裡仍有存水</p>	<ul style="list-style-type: none"> ● To keep the water in the tray clean, the drain pump will pump out the remaining water in the tray. 為保持水盤裡的水清潔，排水泵會抽走水盤內殘留的水。 →It is not abnormal. Please continue to use the product. 並非故障，請繼續使用。
<p>⑦ A "click" sound is heard at the beginning of operation. 剛開始運轉時發出“喀啦喀啦”聲</p>	<ul style="list-style-type: none"> ● This is the sound of pumping water made by the drain pump in the main unit. 這是主機內的排水泵抽水的聲音。 →It is not abnormal. Please continue to use the product. 並非故障，請繼續使用。
<p>⑧ A "puchee" sound is heard. 發出“撲嗒”“撲嗒”聲</p>	<ul style="list-style-type: none"> ● This is the sound of supplying water from the water supply tank. 這是從供水水箱進行供水的聲音。 →It is not abnormal. Please continue to use the product. 並非故障，請繼續使用。
<p>⑨ A rumbling sound is heard. 發出“咕嚕咕嚕”的水流聲</p>	<ul style="list-style-type: none"> ● This is the sound of pumping water made by the drain tank. You need to wait for a while when the room temperature is low in winter or when the water temperature is low. 這是排水水箱抽水的聲音。 當冬季室溫較低時或水溫較低時可能需要等上一段時間。 →It is not abnormal. Please continue to use the product. 並非故障，請繼續使用。
<p>⑩ The indicator does not light on even after is pressed. 即使按 ，指示燈也不亮起</p>	<ul style="list-style-type: none"> ● Is the power plug disconnected? 電源插頭是否已拔下? →Make sure the power plug is inserted into the power outlet and press . 請確保電源插頭插入電源插座，按 .
<p>⑪ Water has already flowed into the water supply tank, but the water refill indicator and drain indicator are still blinking. 水已經進入供水水箱，但加水提示燈、排水提示燈仍閃爍</p>	<ul style="list-style-type: none"> ● Are the water supply tank and drain tank installed properly? 是否已正確安裝供水水箱、排水水箱? →Install the water supply tank and drain tank correctly. (Page 15) 請正確安裝供水水箱、排水水箱。(第15頁) ● Is the drain tank emptied? 排水水箱裡的水是否已倒掉? →Empty the drain tank. (Page 15) 請倒掉排水水箱裡的水。(第15頁)
<p>⑫ Water has already flowed into the drain tank, but the drain indicator is still blinking. 水已經進入排水水箱，但排水提示燈仍閃爍</p>	<ul style="list-style-type: none"> ● The drain indicator keeps blinking until sufficient water has been supplied to the tray. 排水提示燈一直閃爍到向水盤內供應足夠的水為止。 →Add water to the water supply tank and install it onto the main unit. (Page 15) 請向供水水箱加水並安裝到主機上。(第15頁)

TROUBLESHOOTING

故障排除

Possible situation 可能發生的狀況	Please confirm the following 請確認以下內容
⑬ The main unit is tilted or falls over. 主機已經傾斜或傾倒	① Disconnect the power plug. 拔下電源插頭。 ② Right the main unit. (Wipe any water off it.) 扶起主機。(擦掉附著的水) ③ Leave the product idle for more than half a day. (If water enters the inside, let it dry completely.) 停置半日以上，不使用。 (若內部進了水，則要使其徹底乾燥。) ④ After water supply/drainage has finished (Pages 13~15), insert the power plug back to resume the operation. 進行供水/排水作業(第13~15頁)後再次插上電源插頭運轉。

List of error codes 異常碼一覽表

- The digital display shows error codes.
Check the error code, disconnect the power plug and do the following.
數字顯示屏上發出異常碼通知。
請在確認異常碼後拔下電源插頭，進行以下處理。

Error code 異常碼	Cause 原因	Action 處置方法
U11	Foreign matter is adhered to the electrode unit. 電極組件上有異物附著。	Clear any foreign objects around the electrode unit. 請清除電極組件周圍的異物。 Reinsert the power plug. 請重新插電源插頭。
U12	The slider latch (electrode unit) is at the top position. 電極組件的把手在滑動槽的上方。	Lower the electrode unit. (Page 19) 請降下電極組件。(第19頁) Reinsert the power plug. 請重新插電源插頭。
	The main unit is tilted or falls over. 主機已經傾斜或傾倒。	Refer to "TROUBLESHOOTING" (Page 27). 請參考“故障排除”(第27頁)。
U13	The drain tank is dirty. 排水水箱污濁。	Clean the drain tank. (Page 17) 請維護保養排水水箱，清除髒漬。(第17頁) Reinsert the power plug. 請重新插電源插頭。
	The tray is not set securely. 水盤放置不正確。	Place the tray securely and be sure to close the front panel properly. (Pages 15 and 19) 請將水盤放穩，務必關好前面板。(第15和19頁) Reinsert the power plug. 請重新插電源插頭。
U14	The water in the tray is not clean. 水盤內的水污濁。	Empty the tray and keeps the water clean. (Page 19) 請倒掉水盤裡的水並進行維護保養。(第19頁) Reinsert the power plug. 請重新插電源插頭。

If the problem still persists after you have finished the above operations, please contact the dealer.
進行上述操作仍未恢復正常時，請聯繫經銷商。

Error code 異常碼	Cause 原因	Action 處置方法
F01	The main unit is faulty. 主機發生故障。	Please contact the dealer for repair. 請聯繫經銷商維修。

SPECIFICATIONS

規格

Model No. 型號	F-JPT70H		
Power supply 額定電壓/頻率	220 V ~ 50 Hz		
Air volume mode 風量運轉模式	High 高	Med 中	Low 低
Power consumption (W) ^{※1} 額定輸入功率 (W) ^{※1}	72	31	20
Noise (dB) ^{※2} 噪音 (dB) ^{※2}	49	37	20
Air volume (m ³ /min) 風量 (m ³ /min)	7.0	4.0	2.0
Continuous operation time with full water (h) ^{※3} 滿水連續運轉時間 (h) ^{※3}	9.6	14.0	22.6
Tank capacity (L) 水箱容量 (L)	About 7.8 (Net capacity: About 7.0) 約7.8 (淨容量: 約7.0)		
Power cord length (m) 電源線長度 (m)	2		
Product dimension (mm) 產品尺寸 (mm)	730 (H) x 510 (W) x 307 (L) 高730 × 寬510 × 長307		
Product weight (kg) 產品重量 (kg)	About 17 約17		

※1 The power consumption is about 1 W when the power plug is inserted into the power outlet and the operation is "Off". (17 W for cleaning operation)

在將電源插頭插入電源插座的狀態下，運轉為“關”時的消耗功率約1 W。（清潔運轉時17 W）

※2 The noise is A-weighted sound pressure level, measured in a total silencing laboratory environment. 噪音為A計權聲壓級，在全消音噪音實驗室環境下測得。

※3 The continuous operation time with full water is obtained in an environment where the room temperature is 20 °C and the relative humidity is 30%. The continuous operation time may differ depending on the room temperature and humidity.

滿水連續運轉時間為室內溫度20 °C、濕度30% 環境下的數值。根據室內溫度和濕度情況，連續運轉時間也不一樣。

Panasonic Corporation

Web site: <http://www.panasonic.com>

© Panasonic Corporation 2020

Issue date: 09/2020

發行: 2020年09月

P0920-0 JPT7H8950 C