



# Panasonic®

## OPERATING INSTRUCTIONS

### 使用說明書

## Humidifying Air Purifier 加濕空氣清新機

Model No. 型號 **F-VXV70H**

This product is for indoor use only

本產品為室內專用

### CONTENTS

SAFETY PRECAUTIONS .....	2~6
SETTING AND OPERATING REQUIREMENTS .....	7
PRODUCT FEATURES .....	8~10
MAIN PARTS IDENTIFICATION .....	11~12
SETUP .....	13~15
OPERATION .....	16~20
• POWER OFF/ON • CLEAN/HUMIDIFYING .....	16
• AIR VOLUME • AIRFLOW .....	17
• ECONAVI • HUMIDITY SETTING .....	18
• SPOT AIR • TIMER .....	19
• CHILD LOCK .....	20
MAINTENANCE .....	20~25
• CLEANING METHOD .....	21~24
• FILTER REPLACEMENT .....	25
• WHEN IDLE FOR A LONG TIME .....	25
FURTHER INFORMATION .....	26~29
FAQ .....	30~31
TROUBLESHOOTING .....	32~34
WHEN THE LOUVER SHIFTS .....	35
SPECIFICATIONS .....	35~BACK COVER
OPTIONAL ACCESSORIES .....	BACK COVER

### 目錄

安全注意事項 .....	2~6
設置與使用要求 .....	7
產品特點 .....	8~10
主要部件名稱 .....	11~12
設置 .....	13~15
使用方法 .....	16~20
• 運轉 關/開 • 空氣淨化/加濕 .....	16
• 風量 • 氣流 .....	17
• ECONAVI • 濕度設定 .....	18
• 定向氣流 • 定時 .....	19
• 兒童安全鎖 .....	20
維護保養 .....	20~25
• 清潔方法 .....	21~24
• 更換過濾網 .....	25
• 長期閒置時 .....	25
更多信息 .....	26~29
常見問題解答 .....	30~31
故障排除 .....	32~34
導風板移位時 .....	35
規格 .....	35~末頁
自選配件 .....	末頁

確認與設置  
CONFIRMATION  
AND SETUP

使用方法  
OPERATION

維護保養  
MAINTENANCE

其他信息  
OTHER  
INFORMATION

### Warranty card attached

Thank you very much for purchasing this Panasonic product.  
Please read these instructions carefully before operating or maintenance.  
Also, be sure to read the "SAFETY PRECAUTIONS" (P.2~6) section before operation.  
Failure to comply with instructions could result in injury or property damage.  
Make sure that the correct information is written on the warranty card, including the date of purchase and the name of the dealer. Keep the warranty card in a safe place along with the instructions for future reference.

### 附保證書

感謝您選購Panasonic產品。  
使用和維護產品前，請仔細閱讀本使用說明書。  
使用前，請務必先閱讀“安全注意事項”（第2~6頁）。  
不遵照本說明書進行操作有可能導致受傷或財產損失。  
請確認保證書中已填寫“購買日期、經銷商名稱”等信息後，將其與使用說明書一同進行妥善保管。

# SAFETY PRECAUTIONS

## 安全注意事項

Please follow strictly  
請務必遵守

- Disconnect power supply before maintenance and filling water.  
維護保養和加水前先斷電。
- For cleaning and descaling see "maintenance" and regarding filling (water supply) see "SETUP".  
清潔和除垢詳情請參照[維護保養]。關於加水詳情請參照[設置]。
- If the supply cord is damaged, it must be replaced by the manufacturer, its service agent or similarly qualified persons in order to avoid a hazard.  
如果電源軟線損壞，為了避免危險，必須由製造商、其維修部或類似部門的專業人員更換。
- This product is not intended for use by persons (including children) with reduced physical, sensory or mental capabilities, or lack of experience and knowledge, unless they have been given supervision or instruction concerning use of the product by a person responsible for the safety. Children should be supervised to ensure that they do not play with the product.  
本產品不適合有殘疾、智障或精神障礙的人士或缺乏經驗、常識者(包括兒童)維護使用，除非在負責他們安全的人士的看護或指導下使用。兒童應該有人進行看護，以防將產品當作玩具。

The safety precautions should be strictly followed in order to prevent injury or damage to properties.  
為了避免對您或其他人造成傷害或財物損害，請務必遵守安全注意事項。

- The following symbols differentiate the levels of danger or injury that may result if the product is not used correctly as instructed.  
以下標誌是根據不按指示使用產品所產生的危險或受傷程度進行分類。

### **WARNING 警告**

Those things shown in this column indicate that there is possibility of causing death or severe injury.  
本標誌所表示的內容為“不遵守的話可能造成人員死亡或重傷”。

### **CAUTION 注意**

Those things shown in this column indicate that there is possibility of causing minor injury or damage to properties.

本標誌所表示的內容為“不遵守的話可能造成人身輕傷或財物損害”。

- The following symbols are used to indicate the type of instructions that need to be followed.  
(The symbols given below are examples)  
以下標誌為務必遵守的指示種類。(下列標誌為例子)



This symbol indicates an action that must not be performed.  
此標誌表示禁止事項。



This symbol indicates an action that must be performed.  
此標誌表示強制事項。

### **WARNING 警告**



- Do not touch the power plug with wet hands.  
禁止用濕手接觸電源插頭。  
(Otherwise, electric shock may occur.)  
(否則可能會導致觸電。)



- Do not let the product get wet.  
禁止弄濕機體。
  - Do not place cups, etc. on the product.  
禁止在機體上放置水杯等。  
(Otherwise, the product may short circuit with the possibility of fire or electric shock.)  
(否則產品可能會短路，導致火災或觸電。)



- Do not insert your fingers, metallic objects or others into the air inlet, air outlet or gaps.  
禁止將手指或金屬物等異物放入進風口、出風口或縫隙中。  
(Otherwise, you may be hurt by the inner units with the possibility of electric shock or injury.)  
(否則可能會接觸到產品內部，導致觸電或受傷。)

# SAFETY PRECAUTIONS

## 安全注意事項

Please follow strictly  
請務必遵守

### WARNING 警告



■ Do not pull the power cord when carrying or storing the product.

移動或存放時禁止拉扯電源線。  
(Otherwise, the power cord may be damaged with the possibility of fire or electric shock.)  
(否則電源線可能會損壞,導致火災或觸電。)

■ Do not damage the power cord or power plug.

禁止損壞電源線或電源插頭。  
• Do not cut, modify, excessive distort, twist, squeeze the power cord, and do not place it near heat sources, place heavy weight on it, etc.  
禁止切割、改裝、過度扭曲、擰絞、擠壓電源線、使電源線靠近熱源以及在電源線上壓放重物等。  
(Otherwise, the power cord may be damaged with the possibility of fire or electric shock.)  
(否則電源線可能會損壞,導致火災或觸電。)

■ Do not use chloric or acid detergents.

禁止使用氯類以及酸性的洗滌劑。  
(Toxic gases given off by the detergent may be harmful to your health.)  
(洗滌劑中散發出的有毒氣體損害健康。)

■ Do not use power other than the rated voltage.

禁止使用額定電壓以外的電源。  
(Otherwise, the power cord may be overheated and induce fire.)  
(否則電源線可能會過熱,導致火災。)



■ Prevent wheels from damaging power cord when you move product.

移動時禁止讓輪子損壞電源線。  
(Otherwise, electric shock or fire may occur.)  
(否則可能會導致觸電或火災。)



■ Do not disassemble or modify the product.

禁止擅自拆開或改裝本產品。  
(Otherwise, the product may catch fire or malfunction, thus resulting in fire or electric shock.)  
(否則產品可能導致起火或運作異常,引發火災或觸電。)

→ Contact the dealer for repair.  
需要維修時請聯繫經銷商進行維修。



■ In case of any abnormality or malfunction, stop using the product immediately and disconnect the power plug.

當有以下的任何情況出現時,請立即停止使用本產品並拔出電源插頭。  
(Otherwise, electric shock, fire or smoke may occur.)

(否則可能會導致觸電、起火或冒煙。)

<Examples of abnormality/malfunction>  
<異常·故障的例子>

- Leakage. 漏水。
  - The product stops operating when moving the power cord.  
移動電源線時,產品運轉停止。
  - If any buttons do not work.  
如果任何控制按鈕故障。
  - If the circuit breaker is tripped or when fuse blows.  
如果斷路器起作用或保險絲燒毀。
  - If the power cord or power plug becomes abnormally hot.  
如果電源線或電源插頭異常發熱。
  - If you notice a burning smell or an abnormal sound or vibration.  
如果您發覺有燒焦的異味或異常的聲音或振動。
  - If there is any other abnormalities or malfunctions.  
如果有其他任何異常現象或故障。
- Please stop using the product immediately and disconnect the power plug, and contact the dealer to check and repair.  
立即停止使用,拔出電源插頭,聯繫經銷商進行檢查、維修。

# SAFETY PRECAUTIONS

## 安全注意事項

Please follow strictly  
請務必遵守

### WARNING 警告

-  **■ Clean the power plug regularly.**  
請定期清潔電源插頭。  
(If dust is found on the power plug, insulation may be damaged by humidity and fire may occur.)  
(如果電源插頭上有灰塵，濕氣可能會破壞電源插頭的絕緣部分，導致火災。)
  - Disconnect the power plug and wipe it with dry cloth.  
拔出電源插頭，用乾布擦淨。
  - When the product will not be used for a long period, disconnect the power plug.  
長期不使用產品時，應拔出電源插頭。

-  **■ Insert the power plug completely.**  
請將電源插頭完全插入電源插座。  
(If the power plug is not fully inserted, the power cord may be overheated, thus resulting in fire or electric shock.)  
(如果電源線沒有完全插牢，可能會使電源線過熱導致火災或觸電。)
  - Do not use damaged power plug or loose power socket.  
禁止使用已損壞的電源插頭或鬆動的電源插座。

### CAUTION 注意

-  **■ Do not clean the product with gasoline or other volatile mixture solvents, and avoid contacting with spray insecticides.**  
禁止使用汽油或其他揮發性混合溶劑擦拭產品，以及把殺蟲劑噴到產品上。  
(Otherwise, the product may crack or short circuit with the possibility of injury, fire or electric shock.)  
(否則產品可能會破裂或短路，導致受傷、火災或觸電。)
- Do not sit on or lean against this product.**  
禁止坐、靠本產品。  
(Otherwise, the product may fall over and injury may occur, the water may spill out and fire, electric shock may occur or wet furniture, etc.)  
(否則產品可能會翻倒，導致受傷，水灑出會導致火災、觸電、沾濕傢具等。)
  - Families with children should pay more attention.  
有小孩的家庭要多加注意。
- Do not place the product near combustible materials such as lighted cigarette, incense, etc.**  
禁止將點燃的香煙、香燭等可燃物接近產品。  
(Otherwise, these may be absorbed into the product with possibility of fire.)  
(否則產品吸入易燃物後可能會起火，導致火災。)

-  **■ Do not operate this product in places where indoor fumigation type insecticides are being used.**  
煙熏型殺蟲劑使用時禁止使用本產品。  
(Chemical residue may build up inside the product and discharge from the air outlet, and cause damage to health.)  
(否則產品內可能會積聚藥物，然後從出風口排出，危害身體健康。)
  - Ventilate the room with fresh air thoroughly after using insecticides before operating the product.  
使用殺蟲劑後，應先讓房間徹底通風，然後才可使用本產品。
- Do not push over or overturn the product.**  
禁止推倒或倒置本產品。  
(Otherwise, the water may spill out and fire, electric shock may occur or wet furniture, etc.)  
(否則水灑出可能會導致火災、觸電或沾濕傢具等。)

# SAFETY PRECAUTIONS

## 安全注意事項

Please follow strictly  
請務必遵守

### ⚠ CAUTION 注意



#### ■ Do not use a punctured or damaged tank.

禁止使用開孔或破損了的水箱。  
(Otherwise, the water spill out and may wet furniture, etc.)  
(否則水灑出可能會沾濕傢具等。)

#### ■ Do not use the following water.

禁止使用以下各種水。

- Water mixed with chemicals, air fresheners, alcohol and essential oil.  
加入化學藥品、空氣清新劑、酒精、芳香劑的水。  
(Otherwise, the tank may be damaged and may wet furniture, etc.)  
(否則可能會導致水箱破損，沾濕傢具等。)
  - Water from a water purifier, alkaline ion water, mineral water and well water (where the mildew and miscellaneous bacterium multiply fast).  
淨水器的水、鹼離子水、礦物質水以及井水。  
(因為霉菌及各種細菌繁殖較多。)
- When you feel uncomfortable, please consult a doctor at once.  
當身體感覺不適時，請立即諮詢醫生。



#### ■ When disconnecting the power plug, hold the power plug instead of the power cord.

請手持電源插頭部位拔出電源插頭。  
(Otherwise, the power cord may be damaged with the possibility of fire or electric shock.)  
(否則電源線可能會損壞，導致火災或觸電。)

#### ■ Keep the room well-ventilated when using the product together with a burner.

與燃燒器具一起使用時，需保持空氣流通。  
(Otherwise, carbon monoxide poisoning may occur.)  
(否則可能會導致一氧化碳中毒。)

- This product cannot remove carbon monoxide.  
本產品不能去除一氧化碳。



#### ■ Do not place the product in the following places.

- 禁止放置本產品於以下場所。
- Incline and unstable place.  
不平穩的場所。  
(Otherwise, the product may fall over and injury may occur, the water may spill out and fire, electric shock may occur or wet furniture, etc.)  
(否則產品可能會翻倒，導致受傷，水灑出會導致火災、觸電、沾濕傢具等。)
  - Where the temperature or humidity is extremely high, or watery area, such as bathroom.  
浴室等高溫、高濕或會弄濕產品的場所。  
(Otherwise, current may leak with the possibility of fire or electric shock.)  
(否則產品可能會漏電，導致火災或觸電。)
  - Where oil fume is emitted, such as in kitchens.  
廚房等排放油煙的場所。  
(Otherwise, the product may crack and injury may occur.)  
(否則產品可能會破裂，導致受傷。)
  - Where oil or inflammable gas is present and may be leaked.  
使用油或可燃性氣體並可能出現洩漏的場所。  
(Otherwise, a fire may occur due to ignition in the product.)  
(否則吸入產品內可能會起火，導致火災。)
  - Where the air outlet faces animals or plants directly.  
出風口正對動植物的場所。  
(Otherwise, it may cause discomfort to animals and dry out plant.)  
(否則可能會導致動物不適、植物風乾。)



#### ■ Please pull out the tray slowly.

取出水盤時，請緩慢將水盤拉出。  
(If pull out quickly, the water may spill out and wet furniture, etc.)  
(快速拉出水盤時，水可能會灑出，沾濕傢具等。)

### ⚠ CAUTION 注意

#### ! ■ Discharge water after removing the tray, and do not discharge water from the product directly.

進行水盤的排水時，請務必取出水盤後排水，不能從機體上直接排水。  
(Otherwise, fire or electric shock may be caused due to short circuit.)  
(否則產品可能會短路，導致火災或觸電。)

#### ■ Be sure to always keep the water in the tank and interior of the product clean.

要一直保持水箱中的水及主機內部清潔。

- Replace the water in the tank with new tap water every day.  
經常用新的自來水更換水箱中的水。
- Maintain the interior of the product periodically.

要定期清潔保養機體內部。

(If the interior is contaminated by dirt or incrustation, a foul odor may occur due to mildew and miscellaneous bacterium breed, and thus do harm to your health, depending on individual constitution.)

(當內部被污漬以及水銹污染後，因霉菌和各種細菌繁殖而產生惡臭，同時因個人體質不同也可能會危害身體健康。)

- When you feel uncomfortable, please consult a doctor at once.  
當身體感覺不適時，請立即諮詢醫生。

#### ! ■ When carrying the product.

移動產品時。

- Turn off the product and disconnect the power plug, take out the tank, and pour water out of the tray.

請停止運轉產品並拔出電源插頭，再取出水箱，倒掉水盤中的水。

(Otherwise, the water may spill out and fire, electric shock may occur or wet furniture, etc.)

(否則水灑出可能會導致火災、觸電或沾濕傢具等。)

- Hold the left and right handles, but not the louver, front panel or tank handle to carry the product.

請握住左右把手，不可握住導風板、前面板或水箱把手移動產品。

(Otherwise, the product may fall off injury may occur.)

(否則可能會發生滑落，導致受傷。)



#### ■ When moving the product by the wheels.

用輪子移動產品時。

- Before moving the product, please unlock the fixed hook from wheels first.

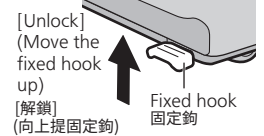

先解除輪子的固定鉤再移動。

(Otherwise, the product is easily turned over and result in injury.)

(否則產品可能會翻倒，導致受傷。)

#### ■ Move the product horizontally.

請橫向移動產品時。

(Otherwise, the floor or carpet may be scratched.)

(否則可能會刮傷地板或地毯。)

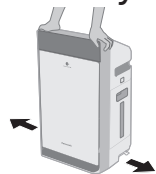

#### ■ Hold the handles to lift up and carry the product onto the carpet.

請握住把手向上將產品抬到地毯上。

(Otherwise, the carpet may be scratched.)

(否則可能會刮傷地毯。)

# SETTING AND OPERATING REQUIREMENTS

## 設置與使用要求

### Area that can enhance the effectiveness!

在這些場所使用，非常有效！



#### ■ Place it on the floor as a countermeasure against pollen.

針對花粉等室內揚塵，將產品放置在地面上。

Since dust or pollen is likely to float in the air near the floor, we recommend you put the product on the flat floor in the room.

由於花粉、灰塵等容易落到地板附近，建議將本產品放在房間平坦的地面上。

#### ■ Way to circulate air more effectively.

使房間裡的空氣有效循環。

Set the product with its left, right and top about 30 cm or more away from walls, furniture or curtains, etc., otherwise, the pollutants are difficult to be cleared.

To ensure effectiveness of this product, keep its back at least 1 cm away from the wall.

請將本產品設置在其左右與上方距離牆壁、傢俱、窗簾等約30 cm以上的地方，否則污染物難以被吸入機體。

為了更有效地使用本產品，請保持產品背部距離牆壁至少1 cm。

#### ■ Do not set the product in the following places.

請勿設置本產品於以下場所。

- Where the product will be exposed directly to sunlight, outlet of air conditioner or heat, etc.

陽光直射、被空調吹到或受熱等場所。

(Otherwise, deformation, degeneration, discolor or malfunction may be occurred.)

(否則可能會造成變形、老化、變色或故障。)

- Near equipment such as TV and radio.

電視機及收音機等物體附近。

(Otherwise, visual disturbances or noises may be caused.)

(否則可能會導致影像紊亂以及雜音。)

- Keep the product 1 m or above away from such devices.

距離1 m以上設置。

- Where window or other objects may obstruct the humidity sensor.

窗邊等可能擋住濕度感應器的場所。

(Otherwise, the sensor may not work normally.)

(否則可能會導致濕度感應器工作不正常。)

#### ■ Do not place obstacles on the product air inlet and outlet.

請勿在產品進風口和出風口處放置障礙物。

(Otherwise it may affect product performance.)

(否則可能會影響產品性能。)

#### ■ If the product is used in the same place for a long period.

在同一場所長時間使用時。

It may result in dirty surrounding walls or floor. We recommend that you move the product away from where it is placed when maintaining it.

產品周圍的牆壁及地板會有污漬，進行產品維護保養時，建議改變設置場所。

#### ■ When there may be freezing, please empty the tank and tray.

有可能發生凍結時，請倒掉水箱和水盤中的水。

(If the product operates in the frozen status, malfunction may be caused.)

(在結冰狀態下運轉，產品可能會發生故障。)

#### ■ Do not use the same power socket with TV, radio, etc.

請勿與電視機、收音機等設備使用同一電源插座。

(Otherwise, visual disturbances or noises may be caused.)

(電源插頭插入時有可能會產生影像紊亂以及雜音。)

- In this case, insert the power plug into another power socket.

請將電源插頭插到其他電源插座上。

#### ■ Do not place any object on the product.

請勿在產品上放置物品。

(Otherwise, an operation error or malfunction may be caused.)

(否則產品可能會誤操作或故障。)

- Do not place magnet or metal objects on the product.

請勿在產品上放置磁鐵或金屬物品。

(May be induced with the product's built-in magnet, resulting the check indicator lights on, and the product cannot be operated.)

(可能會與產品操作面板內的磁鐵感應，導致檢查指示燈亮起，產品無法操作。)

## PRODUCT FEATURES

### 產品特點

The “Mega catcher” and humidifying function can bring moist and clean air to you.

- When the sensor detects contaminated indoor air, the front panel will automatically glide upward to implement strong adsorption. [Equipped with double layer louver]
- It is activated by the human activity sensor to operate beforehand to prevent indoor pollutants from dispersing and collect dust at high speed.
- Equipped with nanoe<sup>®</sup> X technology.
- The Econavi mode enables the product to operate in power saving mode.

“Mega catcher”與加濕功能給您帶來濕潤、潔淨的空氣

- 感應器檢測到室內空氣污染物時，前面板會自動向上打開，強力吸入污染物 [配備雙層導風板]
- 通過人體感應先行運轉，防止室內污染物擴散，高速集塵
- 配備nanoe<sup>®</sup> X技術
- 通過Econavi模式，省電運轉



# PRODUCT FEATURES

## 產品特點

### ■ About nanoe® X

#### 關於nanoe® X

- The so-called nanoe® X are charged water purification particles generated by applying high voltage to separate water molecules.  
所謂nanoe® X，是通過施加高電壓來分離水分子而產生的帶電淨水粒子。
- nanoe® X features: high moisture content, small particles, high stability, etc.

nanoe® X特點：水分含量多、顆粒小、穩定性高等。

1. High moisture content (the moisture content is 1,000 times the moisture content of ordinary anions).  
水分含量多(水分含量為一般負離子的含水量的1000倍)。
2. Small particles (about 5 nm - 20 nm (nanometers) in size, able to penetrate deep into the fiber and stratum corneum).  
顆粒小(大小約為5 nm - 20 nm(納米)，可滲透到纖維及角質層深處)。
3. High stability (6 times more stable than a common ion, covering a distance of 10 m or above).  
穩定性高(比一般負離子穩定性高6倍，覆蓋距離高達10 m以上)。
4. More hydroxyl radicals (up to 4,800 billion of radicals are generated per second).  
OH自由基多(每秒產生OH自由基達48000億個)。
5. Weak acidity (with weak acidity features close to that of hair and skin).

弱酸性(具有與髮質和皮膚接近的弱酸性特性)。

All of the above features have been tested by SGS-CSTC Standards Technical Services Co., Ltd.

上述特點均經過SGS通標標準技術服務有限公司檢測。

Note: nanoe® and the nanoe® mark are trademarks of Panasonic Holdings Corporation.

注：nanoe® 和nanoe® 標記為松下電器產業株式會社商標。

nanoe® X are particulate ions containing hydroxyl radicals whose amount is 10 times that of nanoe®.

nanoe® X 是含有nanoe® 10倍量的OH自由基的微粒子離子。



# PRODUCT FEATURES

## 產品特點

### ■ About "Mega catcher"

#### "Mega catcher" 介紹

When the sensor (P.27) detects dirt in the air, the front panel opens according to the type and degree of the dirtiness to absorb the dirt by the best airflow. (P.29)

具有通過感應器(第27頁)檢測空氣中的污濁,根據空氣污濁的類型以及程度大小,前面板打開,利用最佳空氣流動吸收污濁的功能。(第29頁)

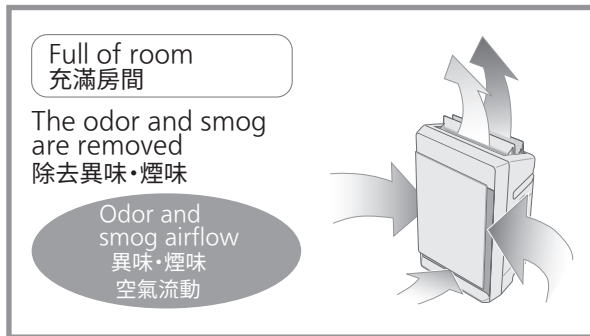

### ■ About "Human activity sensor"

#### 關於“人體感應器”

The product can automatically adjust the air volume when it detects an action of a person or pet. It predicts generation of indoor dust and operates before indoor air pollutants disperse.

(When "Auto Vol.", "Full Auto", "Econavi" is selected.)

(Not all the pet actions can be detected.)

檢測到人或寵物的動作,自動調節風量。預測到室內灰塵的產生,在室內空氣污染擴散前先行運轉。

(選擇“風量自動”、“全自動”、“Econavi”時)

(並非能檢測到所有寵物的動作)

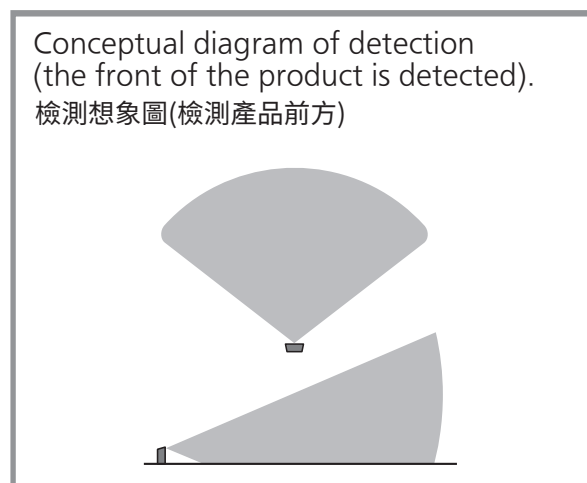

### ■ About "Sleep Mode Auto Operation" (P.27~28)

#### 關於“睡眠自動運行模式”(第27~28頁)

Detects the indoor brightness by the light sensor, and automatically adjusts the brightness of indicators on control panel and front indication, and the air volume.

通過亮度感應器檢測室內亮度,自動調節操作面板的指示燈及前方指示燈的亮度以及風量大小。

# MAIN PARTS IDENTIFICATION

## 主要部件名稱

### Front 正面

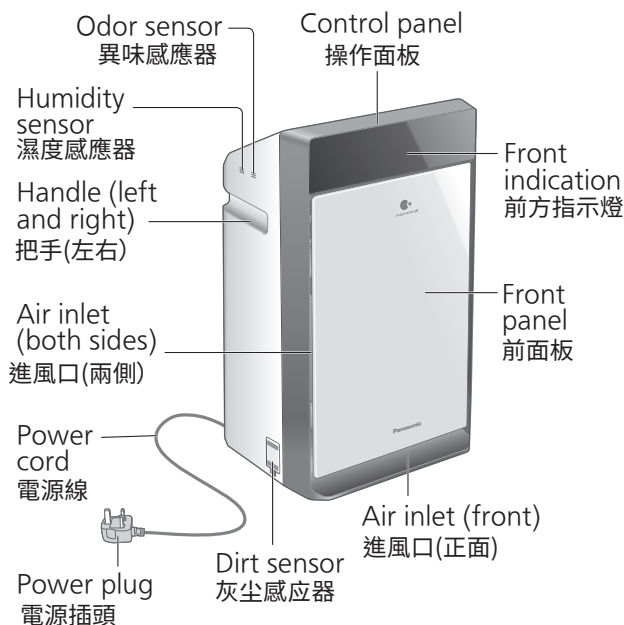

### Back 背面

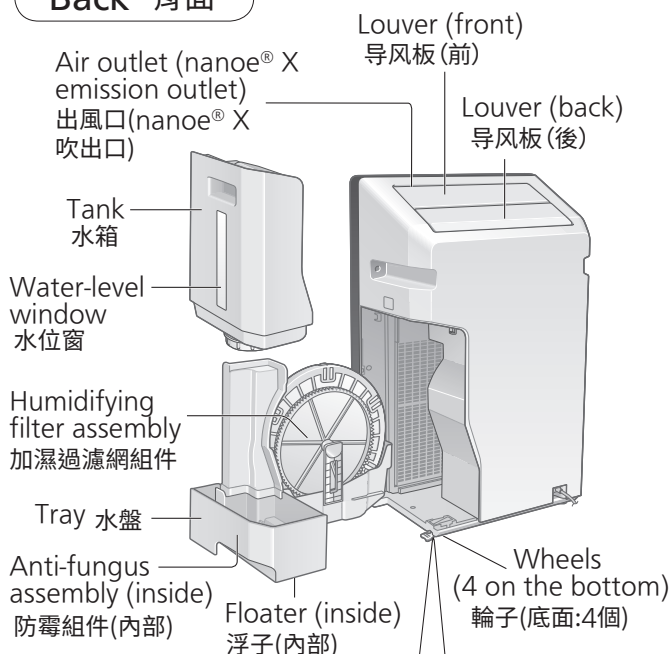

確認與設置  
CONFIRMATION  
AND SETUP

■ Lock the wheels: press down the fixed hook.

鎖定：按下固定鉤

Unlock the wheels: move the fixed hook up.

解鎖：向上提固定鉤

(The product may move on a slippery floor even if wheels are locked.)

(在比較滑的地面上，即使固定了輪子，產品也有可能滑動。)



### Control panel 操作面板

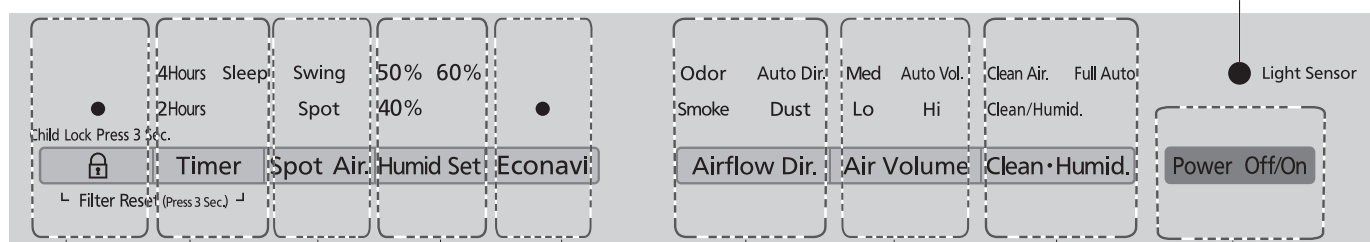

Child lock button/  
indicator  
兒童安全鎖  
按鈕/指示燈

Timer button/  
indicator  
定時按鈕/  
指示燈

Spot air button/  
indicator  
定向氣流  
按鈕/  
指示燈

Humidity setting button/  
indicator  
濕度設定  
按鈕/  
指示燈

Econavi button/  
indicator  
Econavi  
按鈕/指示燈

Airflow button/  
indicator  
氣流按鈕/  
指示燈

Air volume button/  
indicator  
風量按鈕/  
指示燈

Clean/  
Humidifying  
button/  
indicator  
空氣淨化/加濕  
按鈕/指示燈

Power Off/On  
button  
運轉關/開按鈕

### Front indication panel 前方指示燈面板

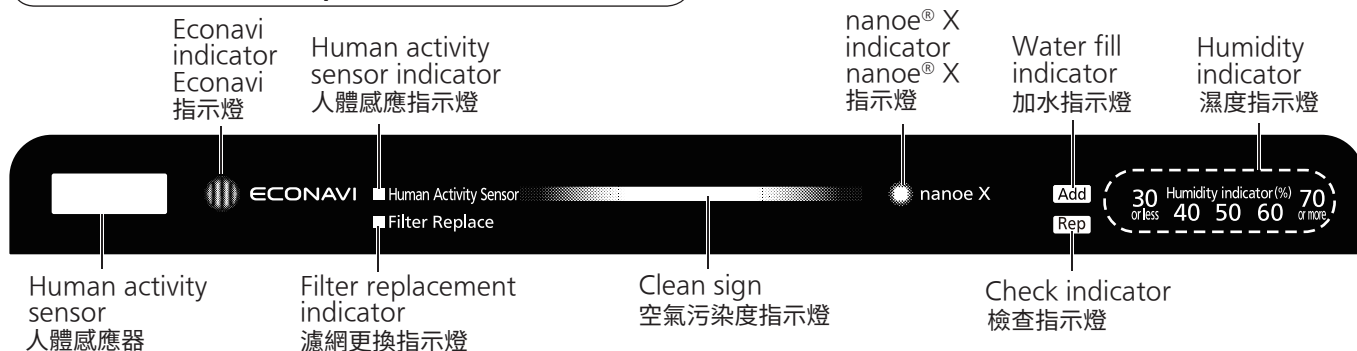

# MAIN PARTS IDENTIFICATION

## 主要部件名稱

### ■ Human activity sensor (P.10)

人體感應器(第10頁)

It detects human activities and prompts you through the human activity sensor indicator (indicator lights on).

The sensor sensitivity is changeable. (P.31)

檢測人的動作，通過指示燈(指示燈亮起)提示。

感應器靈敏度可變。(第31頁)

### ■ Clean sign

空氣污染度指示燈

Show the air pollution levels detected by sensor.

Blue: indicates clean

Purple: indicates slight dirty

Red: indicates dirty

顯示感應器檢測到的空氣污染程度。

藍色：表示乾淨

紫色：表示有點髒

紅色：表示髒

### ■ Dirt sensor and Odor sensor

灰塵感應器和異味感應器

Dirt sensor can detect house dust in air, etc.

Odor sensor can detect odor from cigarettes, etc. The sensor sensitivity is changeable. (P.27)

灰塵感應器可檢測到室內揚塵等，異味感應器可檢測到香煙氣味等。

感應器靈敏度可變。(第27頁)

### ■ Humidity indicator

濕度指示燈

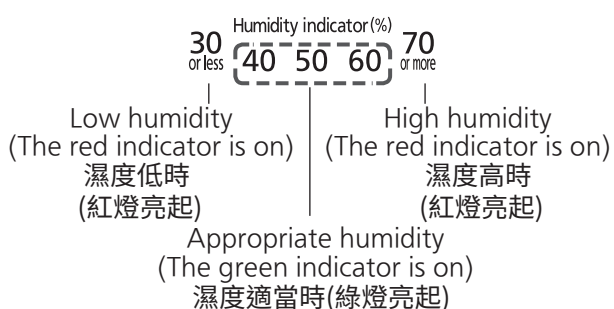

(The indicator displays humidity only, humidity cannot be set.)

(濕度指示燈只是顯示濕度，濕度無法設置。)

The displayed humidity is just an approximate value, which may differ from the value on your hygrometer.

顯示當前室內大概的濕度值，可能會與家中濕度計顯示的數值有差異。

### ■ Light sensor

亮度感應器

The product detects the indoor brightness by the light sensor, and automatically adjusts the brightness of indicators on control panel and front indication, and the air volume. When sleeping, it becomes dark in the room, then the product will enter the "Sleep Mode Auto Operation" mode. (P.27~28)

通過亮度感應器檢測室內亮度，自動調節指示燈的亮度與風量。就寢時，室內變暗，進入“睡眠自動運行模式”。(第27~28頁)

### ■ Water fill indicator

加水指示燈

When the water fill indicator blinks or lights on indicate that you need add water. If you want to humidify, please add water. (P.15)

After filling water, the water fill indicator is off.

- The indicator blinks: The water is used out in "Humidifying mode".
- The indicator lights on: The water is used out in "Auto humidifying mode".

指示燈閃爍或亮起時提示水箱中沒水，需要加濕時，請加水。(第15頁)

加水後，加水指示燈熄滅。

- 指示燈閃爍：加濕模式時水用完。
- 指示燈亮起：自動加濕模式時水用完。

### ■ Check indicator

檢查指示燈

When the check indicator is on (P.34).

檢查指示燈亮起時(第34頁)

### ■ nanoe® X indicator

nanoe® X指示燈

Indicates the nanoe® X is generating when the indicator lights on. nanoe® X will be generated in all operation modes except you switch off it. (P.26)

指示燈亮起表示正在產生nanoe® X。在所有運轉模式下都會產生nanoe® X，除非關閉nanoe® X功能。(第26頁)

# SETUP

## 設置

### Before startup 開機準備

### Install filters 安裝過濾網

- 1** Fill in the label with the first date of use.  
填寫開始使用日期。

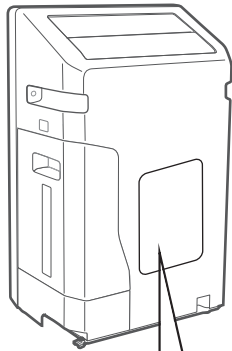

HEPA composite filter replacement	
● Once every 10 years	
Replacement HEPA composite filter	
Part No.	F-ZXKP70Z
Date installed:	
Deodorizing filter replacement	
● Replace a new one when the deodorizing function becomes less effective (Once every 10 years)	
Replacement deodorizing filter	
Part No.	F-ZXFD70Z
Date installed:	
Humidifying filter replacement	
● Once every 10 years (based on operation of 8 hours every day)	
Replacement humidifying filter	
Part No.	F-ZXKE90Z
Date installed:	

#### Notice 提示事項

Be sure to read P.2~6 before startup.  
設置前請務必閱讀第2~6頁。

- 2** Remove the deodorizing filter from poly bag.  
從塑膠袋中取出脫臭過濾網。

- (1) Remove the front panel.  
拆下前面板。

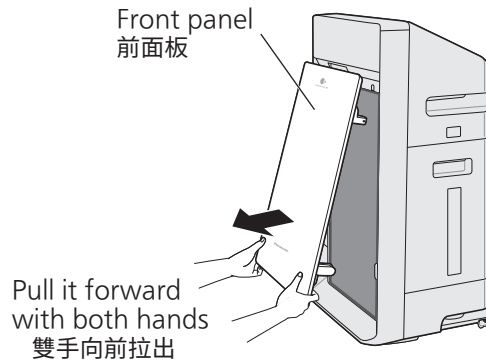

- (2) Toggle the filter hook upward, and remove filters (2 types).  
向上旋轉過濾網鉤，拆下過濾網(2種)。

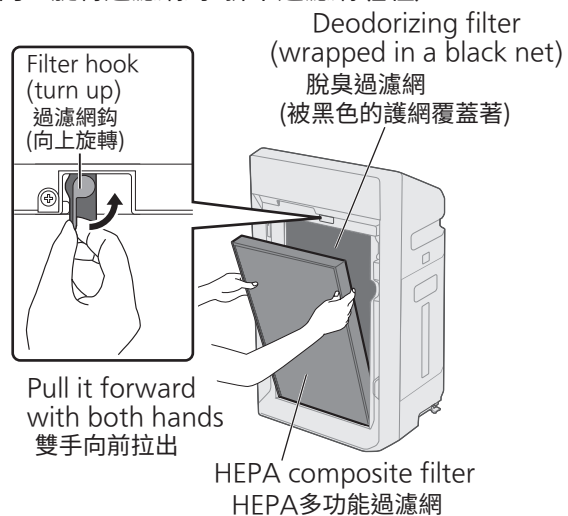

- (3) Remove the deodorizing filter from the poly bag.  
從塑膠袋中取出脫臭過濾網。

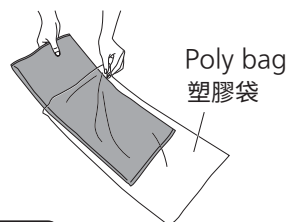

#### Notice 提示事項

Do not remove the black net of deodorizing filter.  
請勿取下脫臭過濾網上黑色的護網。

# SETUP

## 設置

### Install filters 安裝過濾網

## 3 Install the filters (2 types) and the front panel. 安裝過濾網(2種)和前面板。

- (1) Install the deodorizing filter.  
(There is no distinction between inside and outside, upper and lower.)  
安裝脫臭過濾網。  
(無內外、上下的區分)

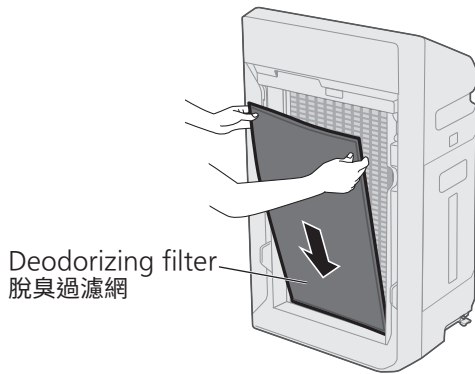

- (2) Install the HEPA composite filter.  
(There is distinction between inside and outside, no distinction between upper and lower.)  
安裝HEPA多功能過濾網。  
(有內外的區分、無上下的區分)

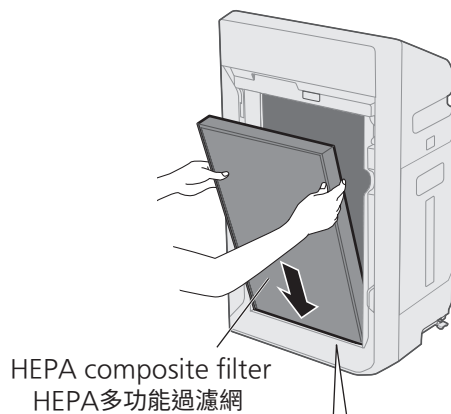

With the black side (front side) towards yourself, fit it into the concave part of the product.  
將黑色面(正面)置於自己跟前，放入主機的凹部。

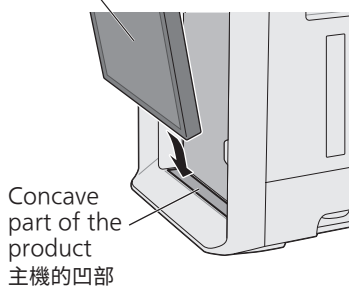

- (3) Toggle the filter hook downward to secure the filter.  
向下旋轉過濾網鉤，固定過濾網。

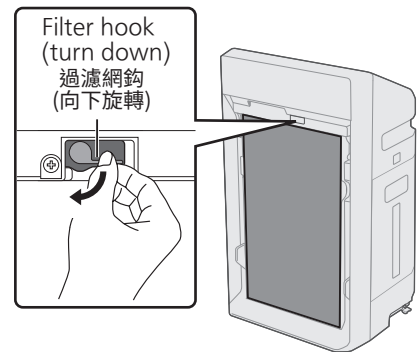

- (4) Install the front panel.  
安裝前面板。

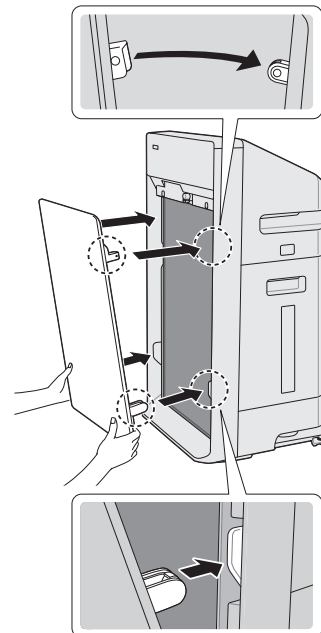

#### Notice 提示事項

Be sure to install the front panel before use.  
使用前請務必安裝好前面板。

# SETUP

## 設置

### Fill water into tank 加水至水箱

- 4 Remove the tank, fill it with water, then install it back.**  
取出水箱加水，加水後，並裝回水箱。  
(Not required if the product operates in the mode of "Clean Air.")  
(空氣淨化模式運轉時，不需要加水。)

■ **Be sure to disconnect the power plug.**  
務必拔出電源插頭。

- (1) Press the hook, remove the tank, then unscrew the tank cover.  
按下掛鉤，取出水箱，然後擰開水箱蓋。

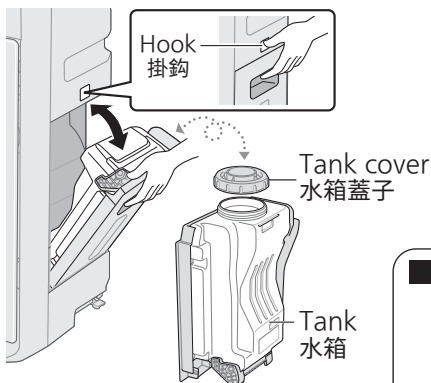

- (2) Fill the tank with water.  
水箱放入水。

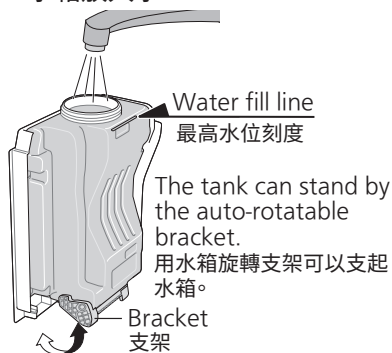

- (3) Screw the tank cover tightly.  
擰緊蓋子。

- Hold the tank to avoid tilting.  
手緊握固定水箱，避免其傾倒。

- (4) Put the tank back.  
將水箱裝回。

- Overturn the tank and install it with the tank cover down.  
翻轉水箱並將水箱蓋朝下安裝。



### Power-on 接通電源

- 5 Connect the power plug.**  
插入電源插頭。  
(Before plugging, wipe off the water on the power plug and your hands.)  
(插入前，請擦乾電源插頭及手上沾的水。)

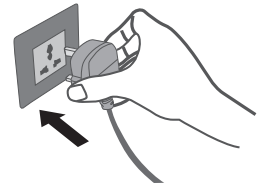

- When inserting the power plug, as the odor sensor uses the degree of cleanliness at this time as the standard, we recommend that you plug it in when the air is fresh (when there is no cigarette smoke). (The standard of the odor sensor automatically updates itself according to the degree of the indoor cleanliness.)

因為異味感應器以插入電源插頭時的空氣潔淨度作為基準，所以建議當室內空氣潔淨時(如沒有煙味時)，插入電源插頭。(異味感應器的基準會根據室內的空氣清潔度自動更新。)

- Press **Power Off/On** button, then the clean sign blinks for about 5 seconds.  
按下 **Power Off/On** 後，空氣污染度指示燈閃爍約為5秒。

■ **Be sure to use the tap water.**

請務必使用自來水。

Because chlorination has been performed generally for tap water and hence the miscellaneous bacterium is difficult to breed. (因為一般都經過了氯化處理，各種細菌難以繁殖。)

■ **Do not use the following water.**

禁止使用以下各種水。

- Hot water above 40 °C, or water mixed with detergents. (Otherwise, the tank deformation may be caused.)  
40 °C 以上的溫水或者加入洗滌劑的水。  
(否則可能會導致水箱變形。)
  - Water mixed with chemicals, air fresheners, alcohol and essential oil. (Otherwise, tank malfunction may be caused and may wet furniture, etc.)  
加入化學藥品、空氣清新劑、酒精、芳香劑等的水。  
(否則可能會導致水箱破損，沾濕傢俱等。)
  - Water from a water purifier, alkaline ion water, mineral water and well water (where the mildew and miscellaneous bacterium multiply fast).  
淨水器的水、鹼離子水、礦物質水以及井水。  
(因為霉菌及各種細菌繁殖較多。)
- When you feel uncomfortable, please consult a doctor at once.  
當身體感覺不適時，請立即諮詢醫生。

**Notice** 提示事項

- If you have to use the well water (drinkable), please maintain and clean the tray, humidifying filter assembly and anti-fungus assembly more frequently.

不得已情況下使用井水(可飲用)時，請增加清潔水盤、加濕過濾網組件、防霉組件的次數。

- A tank of water can operate for about 5 hours. (Under the condition of room temperature 20 °C and humidity 30% when the product operates in high speed.)

一箱水可持續運轉大約5個小時。(在產品高速運轉狀態且室內溫度約20 °C，濕度約30%的條件下。)

# OPERATION

## 使用方法

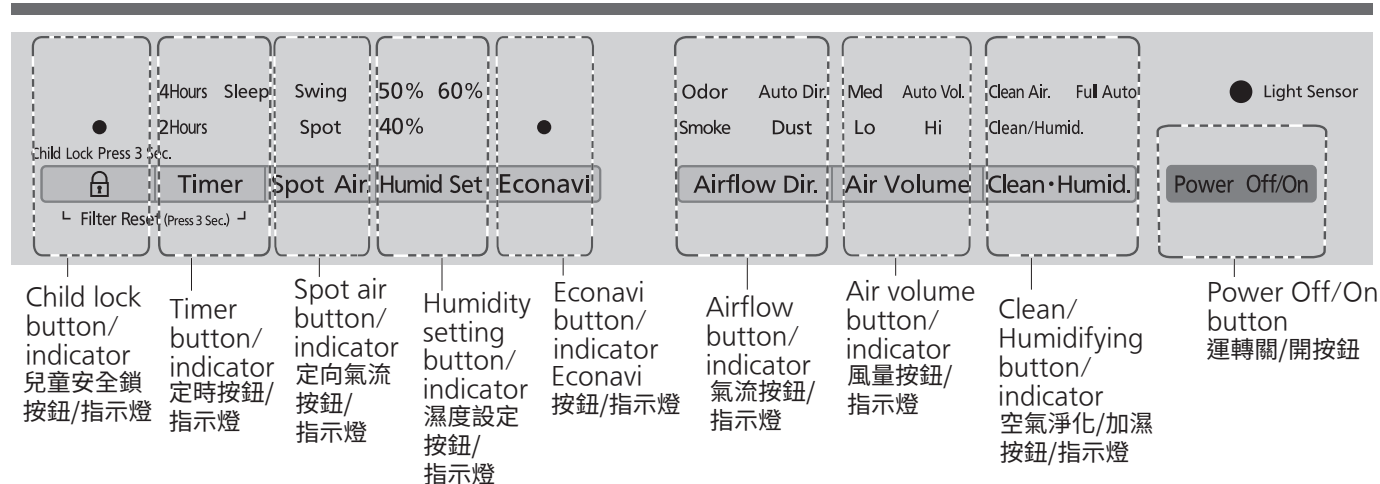

### Power Off/On 運轉 關/開

Power Off/On

**Turn on or off the product. 開始或停止運轉產品。**

Press the button to operate.

The product operates in full auto mode for first time usage, then it will operate based on the last used mode when it is resumed.

按下按鈕產品開始運轉。

初次運轉時以全自動模式運轉，之後以上次停止時的模式運轉。

- Press the button again, the product stops operating.  
再次按下按鈕，產品停止運轉。

### Clean/Humidifying 空氣淨化/加濕

Clean·Humid.

**Select operation mode. 選擇運轉模式。**

The indicator will be changed sequentially as below each time the button is pressed.

每按一下，指示燈將按下圖順序進行切換。

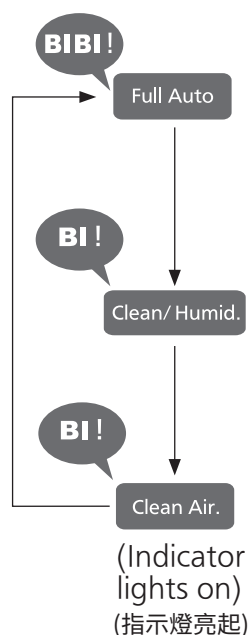

**To operate automatically 想自動運轉時**

- The product will purify the air and adjust the best humidity automatically according to the degrees of the dirt and humidity. The airflow and air volume are controlled automatically. (They cannot be switched manually.)

根據污染和濕度的程度，自行運轉淨化空氣，調節最佳濕度。空氣流動和風量為自動控制。(無法手動切換)

- If there is no water in tank, the product cannot humidifying. 若水箱中沒水，則無法加濕。

**Clean air and humidifying mode**

加濕空氣淨化模式

- If there is no water in tank, the product cannot humidifying. 若水箱中沒水，則無法加濕。

**Clean air mode 空氣淨化模式**

- Water is not required. 不需要在水箱中加水。

■ When water remains in the tank, it will humidify slightly. (Water in the tank will decrease slightly.) If you do not need the humidifying function, please empty the water in tank and tray.

水箱裡有水時，仍會進行少量加濕(水箱中的水會稍微減少)。如不想要加濕效果，請倒掉水箱和水盤中的水。



# OPERATION

## 使用方法

### Air volume 風量

(only for "Clean air and humidifying mode", "Clean air mode")  
(只適用於加濕空氣淨化模式、空氣淨化模式)

Air Volume

**Select appropriate air volume for purifying air or humidifying.**

選擇合適的風量淨化空氣或加濕。

The indicator will be changed sequentially as below each time the button is pressed.  
每按一下，指示燈將按下圖順序進行切換。

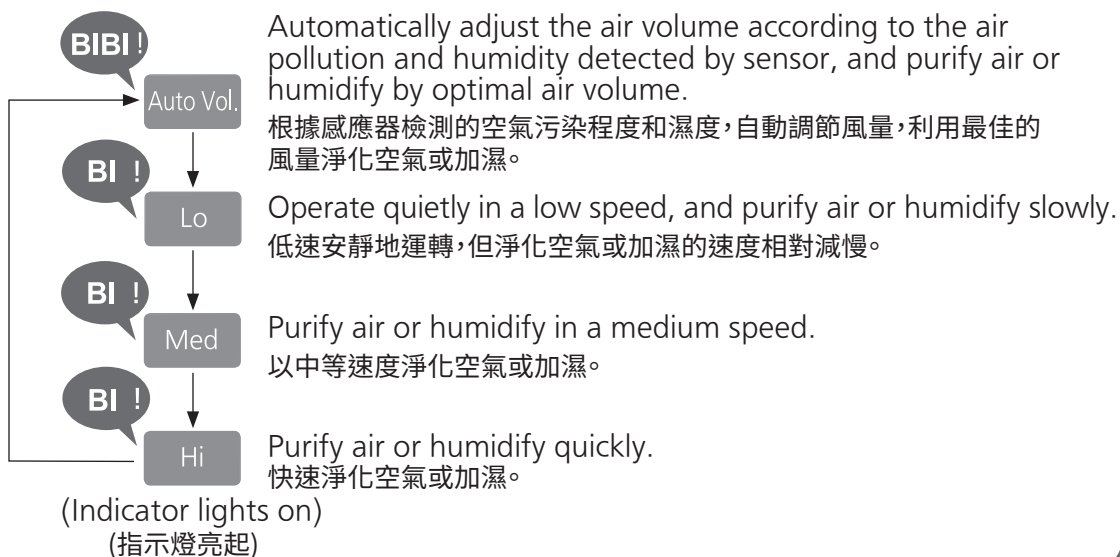

### Airflow 氣流

(only for "Clean air and humidifying mode", "Clean air mode")  
(只適用於加濕空氣淨化模式、空氣淨化模式)

Airflow Dir.

**Change the airflow according to the dirt type.**

根據污染的類型，改變氣流。

The product will generate various airflow by the front panel and louver. (P.29)  
通過前面板和導風板工作產生各式空氣流動。(第29頁)

The indicator will be changed sequentially as below each time the button is pressed.  
每按一下，指示燈將按下圖順序進行切換。

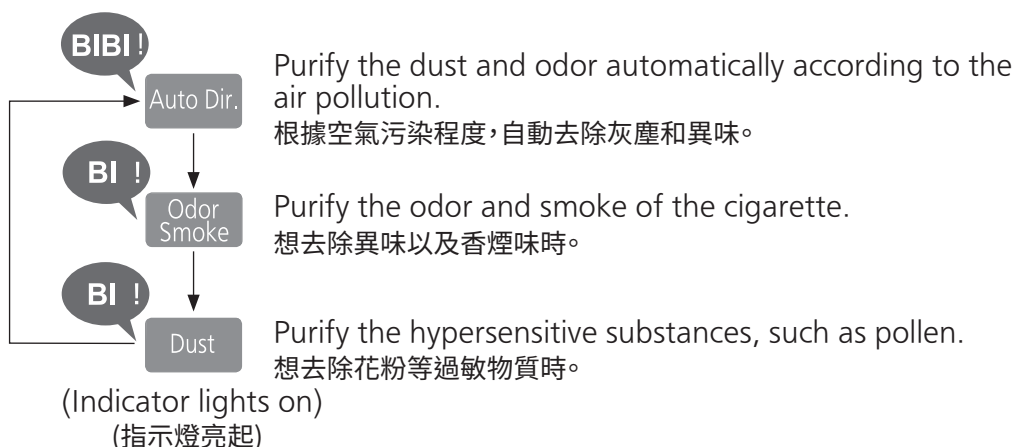

# OPERATION

## 使用方法

### Econavi Econavi

#### Econavi

#### Smart power-saving mode.

省電智能運轉。

Econavi is a smart power-saving operation by combining the "patrol mode" with "learning mode", and adjusts the air volume automatically. (P.28~29)  
Econavi是由“偵測模式”與“學習模式”組合而成的省電運轉模式，並能自動調節風量。(第28~29頁)

■ Press the button again to cancel. (Indicator lights off)

再次按下此按鈕取消。(指示燈熄滅)

(When "Clean Air." or "Clean/Humid." is set, the Econavi can also be canceled by pressing the **Air Volume** button.)

(當以“空氣淨化”或“加濕空氣淨化”模式運轉時，可通過按 **Air Volume** 按鈕進行取消。)



(Indicator lights on)  
(指示燈亮起)

### Humidity setting 濕度設定

(For full auto mode and humidified air purifying mode only [Auto Vol.]

(只適用於全自動模式、加濕空氣淨化模式下的[風量自動]模式)

#### Humid Set

#### Set the humidity.

設定濕度。

The indicator will be changed sequentially as below each time the button is pressed.

每按一下，指示燈將按下圖順序進行切換。

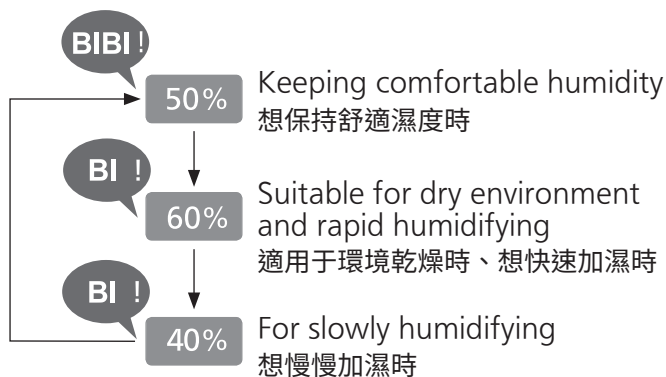

(Indicator lights on)

(指示燈亮起)

Humidity setting (Target)  
濕度設定(目標)

Approximately 50%  
約50%

Approximately 60%  
約60%

Approximately 40%  
約40%

#### Notice 提示事項

■ Due to influence of the surroundings (such as the humidity, temperature or room size), the set humidity may not be reached completely. (P.30 Q7, P.33)

受周圍環境影響(濕度、溫度或房間大小)有可能不能完全達到設定的濕度。(第30頁 Q7，第33頁)

■ When the water fill indicator is on, cannot set humidity.

In the "Clean/Humid." mode, if you set "Econavi" when "Auto Vol." is not set, you can set humidity.

加水指示燈亮起時，不能進行濕度設定。

加濕空氣淨化模式下，當“風量自動”未設定時，如果設定Econavi，可進行濕度設定。

# OPERATION

## 使用方法

### Spot air 定向氣流



**Change the air blow direction by adjust the louver.**

通過調節導風板來改變出風方向。

The indicator will be changed sequentially as below each time the button is pressed.

每按一下，指示燈將按下圖順序進行切換。

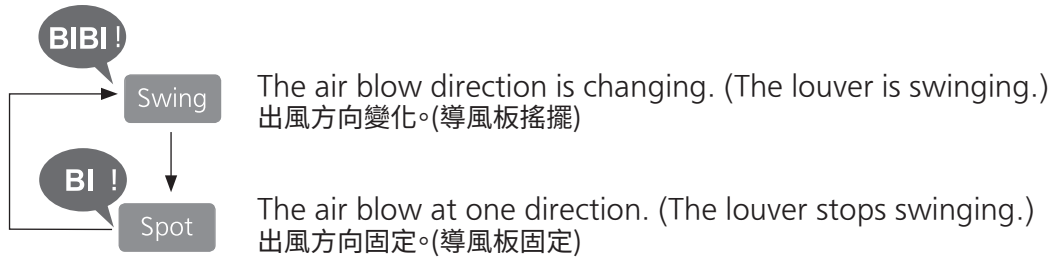

(Indicator lights on)  
(指示燈亮起)

- Press **Air Volume** or **Airflow Dir.** buttons to cancel.  
(Indicator lights off)  
按 **Air Volume** 或 **Airflow Dir.** 按鈕取消。  
(指示燈熄滅)

**Notice 提示事項**

“Econavi” cannot be set in the “Spot Air.” mode.  
“定向氣流”模式下，無法設定“Econavi”。

### Timer 定時



**2 hours, 4 hours or sleep (8h) timer operation.**

2小時、4小時或睡眠模式(8小時)定時運轉。

The indicator will be changed sequentially as below each time the button is pressed.

每按一下，指示燈將按下圖順序進行切換。

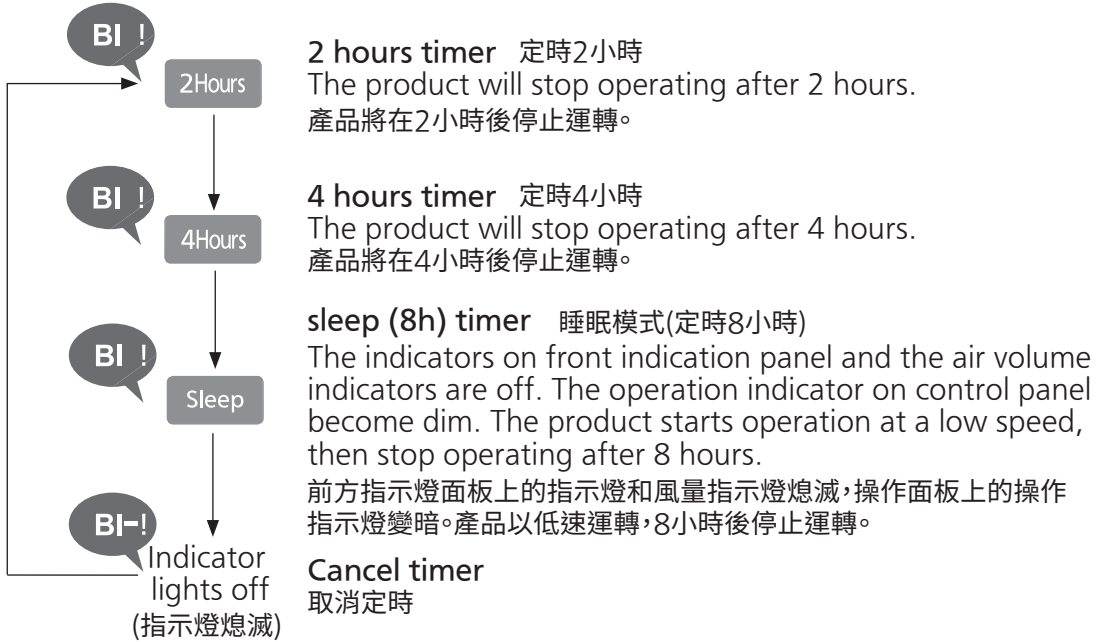

# OPERATION

## 使用方法

### Child lock 兒童安全鎖



(Press 3 sec.)  
(按3秒)



(Indicator lights on)  
(指示燈亮起)

#### To prevent child from wrong pressing.

防止兒童誤操作。

Press the button for about 3 seconds, then the child lock is set.

With this setting, other buttons cannot operate as you press them, it will generate "BI-BI-" sound.

按此按鈕3秒，完成設置。

設置後，按此按鈕以外的其他按鈕將無法操作，並發出“BI-BI-”的提示音。

■ Press the button for about 3 seconds again to cancel. (Indicator lights off)  
再次按3秒取消設置。(指示燈熄滅)

#### Notice 提示事項

When the product is operating, do not adjust the front panel or louver manually.

(Otherwise, the angle and moving range will change.)

→ If you adjusted them manually, please stop the product.

(The product can reset to the normal state when starts again.)

運轉中請勿用手撥動前面板和導風板。(否則角度和移動範圍會改變。)

→ 用手撥動之後，請停止運轉。(再次開始運轉時，能恢復為正常狀態。)

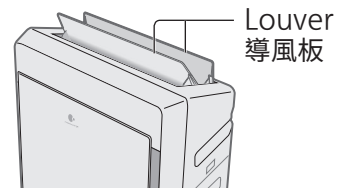

# MAINTENANCE

## 維護保養



### WARNING

#### 警告



Make sure to disconnect the power plug before cleaning the product.

維護保養產品前，請務必拔出電源插頭。  
(Otherwise, the product might operate with the possibility of electric shock or injury.)

(否則產品可能會突然運轉，導致觸電或受傷。)



### CAUTION

#### 注意



Discharge water after removing the tray, and do not discharge water from the product directly.

進行水盤的排水時，請務必取出水盤後排水，不能從機體上直接排水。  
(Otherwise, fire or electric shock may be caused due to short circuit.)

(否則產品可能會短路，導致火災或觸電。)

#### Notice 提示事項

■ Do not use the detergents shown on the right. (The oxygenic bleach can be used only for the humidifying filter.)

請勿使用右方所示洗滌劑。

(僅加濕過濾網可使用氧類漂白劑。)

■ When using chemically treated cloth, be sure to follow the instructions carefully.

使用經過化學處理的抹布時，請務必按說明操作。



# MAINTENANCE

## 維護保養

- For installation and removal methods of front panel, filters and tank, please see P.13~P.15.  
前面板、過濾網及水箱的拆卸及安裝方法見第13~15頁。
- When maintenance, do not leave the removed parts unattended.  
(Otherwise, it may cause tripping or damage.)  
進行維修時,請勿隨意擺放拆卸的零部件。  
(否則可能會絆倒路人或造成零件損壞。)
- Do not operate the product when the HEPA composite filter is removed.  
(Dust will be inhaled into product inner parts, and causes the product breakdown. The HEPA composite filter cannot function while it is removed.)  
HEPA多功能過濾網未安裝時,請勿使用本產品。  
(將失去除塵效果,灰塵進入產品內將造成故障。)
- Do not operate the product when the deodorizing filter is removed.  
(The deodorizing filter cannot function while it is removed.)  
脫臭過濾網未安裝時,請勿使用本產品。  
(否則將失去脫臭效果。)
- Do not operate the product when the humidifying filter is removed.  
(The humidifying filter cannot function while it is removed.)  
加濕過濾網未安裝時,請勿使用本產品。  
(將失去加濕效果。)
- Do not operate the product when the anti-fungus assembly is removed.  
(The anti-fungus assembly cannot function while it is removed.)  
防霉組件未安裝時,請勿使用本產品。  
(將失去防霉效果。)

## Cleaning method 清潔方法

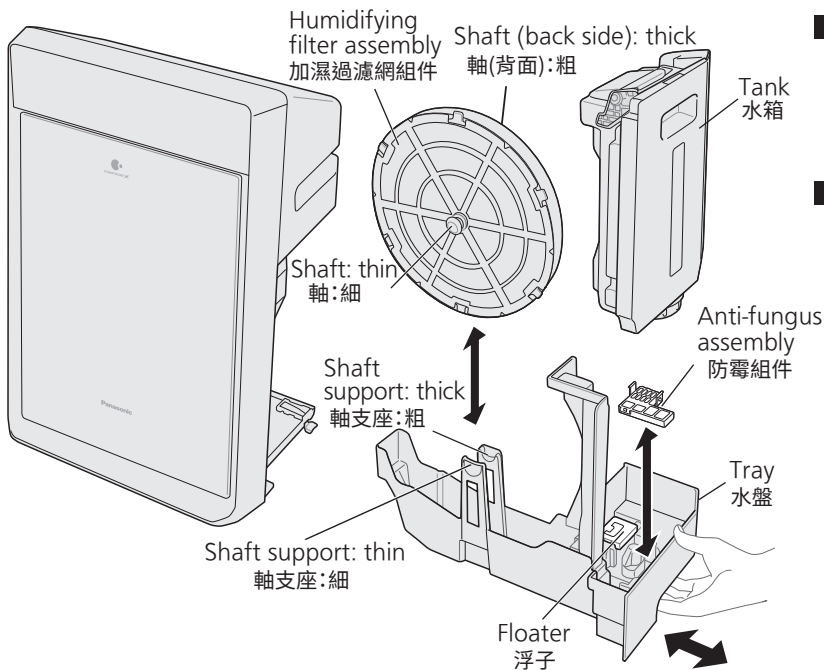

- The humidifying filter assembly has thick shaft and thin shaft. Please be cautions when installing it back to tray. 加濕過濾網組件有粗軸和細軸,裝回水盤時請注意。

- Remove the tank, then pull the tray slowly. 拆下水箱,再緩慢抽出水盤。

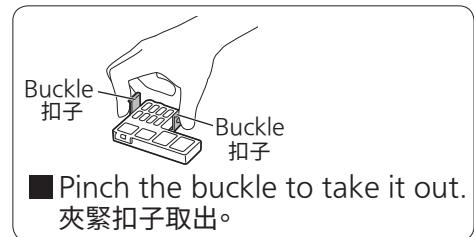

### Tank <every day> 水箱 <每天>

#### Wash it with water 進行水洗

If there is hard stains, please wipe it off with a soft cloth moistened with warm water or water containing neutral detergent for kitchen purpose.  
對於頑固污漬,將抹布放入溫水或加有中性廚用洗滌劑的液體中浸濕,然後擦洗去除污漬。



# MAINTENANCE

## 維護保養

Tray <about once a month<sup>\*1</sup>>  
水盤 <約每月1次<sup>\*1</sup>>

### Wash it with water

進行水洗

(after removing the anti-fungus assembly)  
(取出防霉組件後)

- Wipe the dirt with a swab, or use the toothbrush to scrub it.  
用棉花棒及牙刷去除細微處的污漬。
- Do not remove the floater.  
請勿取下浮子。
- If there is hard stains, please wipe it off with a soft cloth moistened with warm water or water containing neutral detergent for kitchen purpose.  
對於頑固污漬，將抹布放入溫水或加有中性廚用洗滌劑的液體中浸濕，然後擦洗去除污漬。

Anti-fungus assembly <about once a month<sup>\*1</sup>>  
防霉組件 <約每月1次<sup>\*1</sup>>

### Immerse it in kitchen-purpose neutral detergent solution and clean it.

用加有中性廚用洗滌劑的溫水進行浸泡清洗。

- Please soak it in warm water containing neutral detergent for kitchen purpose 30 mins, then wash it 2~3 times with clean water.  
請放入加有中性廚用洗滌劑的溫水中浸泡30分鐘左右，然後再用清水沖洗2~3次。
- Do not disassemble it, scrub it with a brush.  
請勿拆分清洗及勿用刷子刷洗。
- Please keep it level when installing, and fit into the concave part of tray.  
安裝時儘量保持水平，放入水盤的凹部。

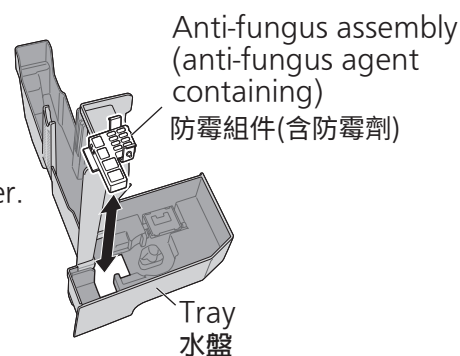

#### Notice 提示事項

- The anti-fungus assembly may have powder sometimes. It has no effect for use.  
防霉組件中有時會出現粉末，並不影響使用。
- The anti-fungus agent will become small along with use. It has no effect for anti-fungus.  
防霉劑伴隨使用會變小，並不影響防霉性能。
- The anti-fungus agent has its own special smell, but harmless to humans.  
防霉劑有其特殊的氣味，對人體無害。
- Function of the anti-fungus assembly  
防霉組件的功能  
Inhibit the mold bacteria with the anti-fungus agent.  
利用防霉劑抗霉菌  
Testing authority: Boken Quality Evaluation Institute  
試驗機構：一般財團法人紡檢品質評價機構  
Testing method: Install the anti-fungus assembly in the tray, and verify the method to prevent mold bacteria (Halo method)  
試驗方法：在水盤內安裝防霉組件，利用防霉試驗方法（暈圈法）進行確認  
Testing result: Verify the effectiveness of preventing mold bacteria.  
試驗結果：確認有抑制效果

※1 As the dirtiness varies with the water quality, maintenance may be required even within one month after the last maintenance if there is unpleasant odor or the water in the tank is reduced in slow speed.

根據水質的不同，污濁狀況會有所不同，因此在清潔後1個月內，若氣味難聞或水箱中的水減少很慢時，也應進行清潔保養。

# MAINTENANCE

## 維護保養

### Humidifying filter assembly <about once a month\*1> 加濕過濾網組件 <約每月1次\*1>

#### 1 Disassembly 拆卸

Remove the 6 hooks from the filter frame.  
拆下過濾網框架上6處掛鉤。

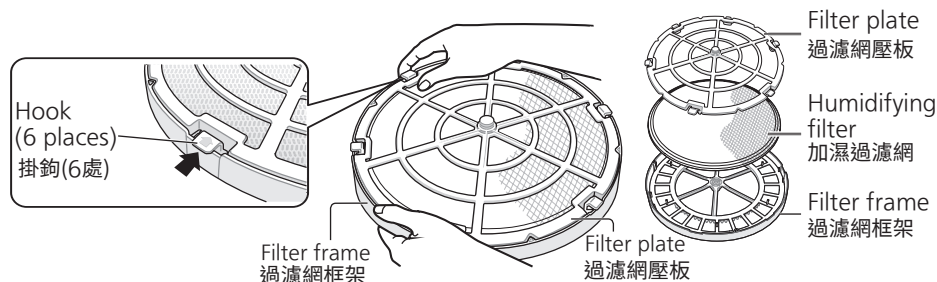

#### 2 Washing 清洗

##### ■ Humidifying filter 加濕過濾網

Press and wash it with clean or warm water (below 40 °C).

用清水、溫水(約40 °C以下)進行按壓清潔。

- Do not scrub it with a brush or wash it with a washing machine.  
請勿用刷子刷洗或用洗衣機清洗。
- Do not dry it with a drier.  
(Doing this may cause shrinkage)  
請勿使用乾燥機乾燥。(可能導致縮小)

- If hard stains is hard to remove, please immerse the heavily stained filter in warm water containing neutral detergent for kitchen purpose or in the solution of citric acid for about 30 minutes and scrub it, then wash for 2~3 times with clean water.  
當污漬或氣味難以去除時,請將過濾網放入加有中性廚用洗滌劑或檸檬酸的溫水中浸泡30分鐘左右,然後用清水沖洗2~3次。

- Wash the filter frame and filter plate with water.  
水洗過濾網框架和過濾網壓板。



##### Notice 提示事項

- Be sure to use the neutral detergent or solution of citric acid. If the alkaline detergent is used, deformation and performance degeneration may be caused.  
請務必使用中性廚用洗滌劑或檸檬酸。鹼性洗滌劑等可能會造成變形,導致性能下降。
- The proportion of citric acid and warm water is 20 g:3 L.  
檸檬酸與溫水的比例為20 g:3 L。

#### 3 Reassembly 安裝

- ① Attach the humidifying filter onto the filter frame.  
(No distinction between inside and outside for the humidifying filter)

將加濕過濾網放入過濾網框架。(加濕過濾網無內外之分)

- Do not make the humidifying filter protrude from the filter frame, or rumple it.  
(Otherwise, the humidifying amount may be reduced.)  
請注意加濕過濾網不要從過濾網框架上露出,也不要弄皺。  
(否則可能導致加濕量變少)

- ② Embed the filter plate into the 6 hooks by aligning it with the filter frame.  
(The protrusions of the triangle align with its indentions.)  
將過濾網壓板對準過濾網框架,全部嵌入6個掛鉤處。  
(三角的突起對準三角的深入部。)

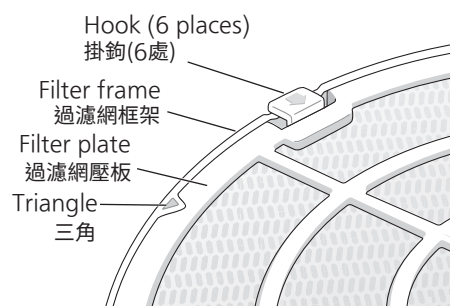

\*1 As the dirtiness varies with the water quality, maintenance may be required even within one month after the last maintenance if there is unpleasant odor or the water in the tank is reduced in slow speed.

根據水質的不同,污濁狀況會有所不同,因此在清潔後1個月內,若氣味難聞或水箱中的水減少很慢時,也應進行清潔保養。

# MAINTENANCE

## 維護保養

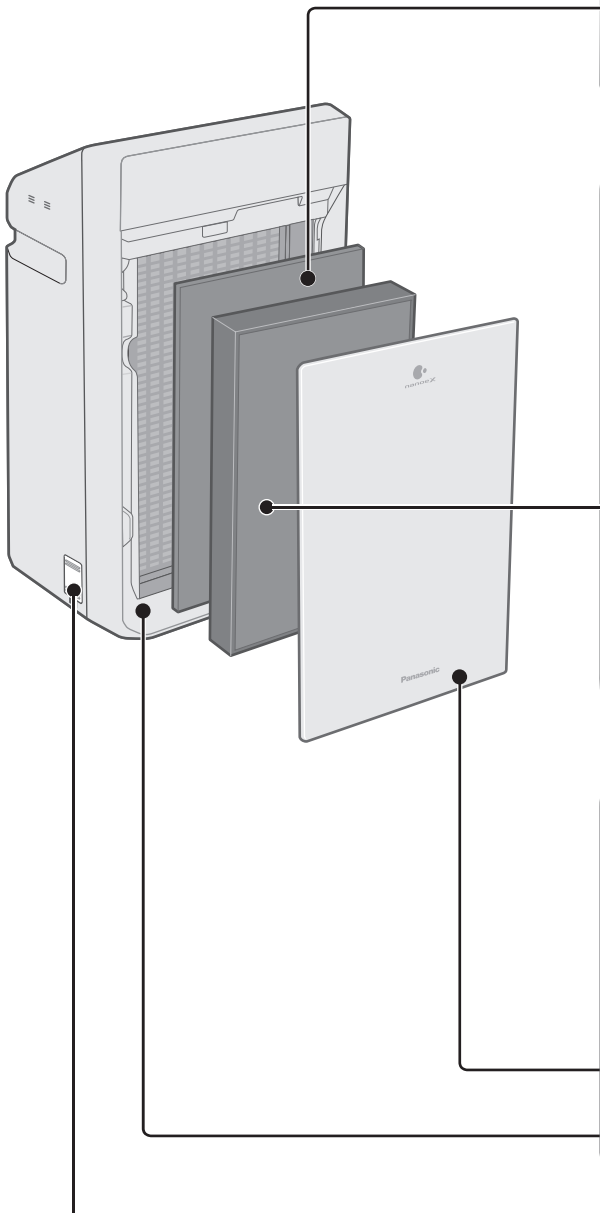

### Deodorizing filter 脫臭過濾網

- When there is dust around the deodorizing filter, remove the dust with a vacuum cleaner, etc. 周圍附著塵埃時，請用吸塵器等吸出清除。
- Do not wash the filter with water. 請勿水洗。

### HEPA composite filter < about once every 2 weeks > HEPA多功能過濾網 <約2周1次>

#### Clean the black side (front side) with a vacuum cleaner, etc.

用吸塵器等去除黑色面(正面)的灰塵

- Please do not apply too much pressure, otherwise the filter may be damaged. 請勿用力按壓，否則過濾網可能會受損。
- Maintenance is unnecessary for the white side (back side). 白色面(背面)無需進行維護保養。
- Do not wash the filter with water. 請勿水洗。

Dusting brush nozzle or gap suction nozzle  
毛刷吸嘴或縫隙吸嘴

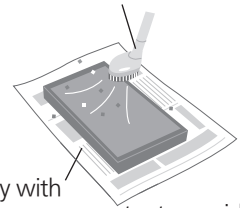

Lay with newspapers etc. to avoid dust messing floor.  
墊上報紙等物品，以免灰塵弄髒地面。

### Body and Front panel < about once a month > 機體及前面板 <約每月1次>

#### Wipe off any dust and dirt using a well wrung-out soft cloth

使用充分擰乾的軟布擦拭污漬

- Do not wipe it with a hard cloth or hardly. Otherwise, the surface may be damaged. 請勿使用粗布擦拭或過度用力擦拭，否則會損傷表面。
- Wipe the power plug with a dry cloth. 請使用乾布擦拭電源插頭。

### Dirt sensor < about once every 3 months > 灰塵感應器 <約3個月1次>

#### Wipe the dirt off the lens with a dry cotton swab

用乾棉棒去除鏡片上的污漬

- ① Remove the external cover of the dirt sensor. 拆下灰塵感應器外蓋。
- ② Wipe the lens with a dry cotton swab as shown below. 使用如圖所示的乾棉棒進行擦拭。

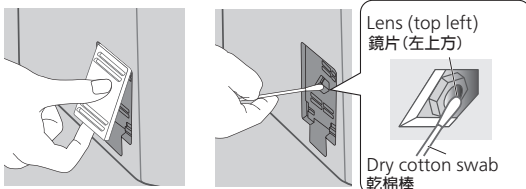

- Wipe the lens periodically. (The sensor may not function normally with accumulation of moisture and smoke from cigarette.) 定期擦拭鏡片。(帶有濕氣以及被香煙的煙油污染後，有可能無法進行正常感應。)
- Do not insert a cotton swab in other parts. 請勿將乾棉棒插入到鏡片以外的其他部位。
- Be sure to disconnect the power before cleaning. 請務必在拔出電源插頭的狀態下進行操作。
- You can use a light to see the lens clearly. 看不清楚鏡片時可用燈光照射。



# MAINTENANCE

## 維護保養

### Filter replacement 更換過濾網

(Optional accessories: back cover)(自選配件:末頁)

	HEPA composite filter HEPA多功能過濾網	Deodorizing filter 脫臭過濾網	Humidifying filter 加濕過濾網
Recommended replacement period 更換週期	When the filter replacement indicator lights on. (About once every 10 years* <sup>1</sup> ) 過濾網更換指示燈亮起時(約10年1次* <sup>1</sup> )		About once every 10 years* <sup>2</sup> 約10年1次* <sup>2</sup>
Conditions 條件	When the product inhales the smoke of 6 cigarettes every day. (Japan Electrical Manufacturers' Association JEM1467) 當產品每天吸入6支香煙排放量時 (日本電機工業協會標準JEM1467)		Based on operation of 8 hours every day (According to an in-house test) 假定1天運轉8小時(本公司內部試驗)

① After replacement (except the humidifying filter), please connect power plug, then press  and **Timer** buttons at the same time for about 3 seconds until the filter replacement indicator turns off then the reset is complete.  
更換過濾網後(除加濕過濾網),請插入電源插頭,再同時按下  和 **Timer** 按鈕約3秒直到過濾網更換指示燈熄滅,則重置完成。

② Fill in installation date on the label attached with filter, then stick it on product to cover the old date. (P.13)  
請在過濾網隨附的標籤上記錄開始使用日期,並粘貼在機體上,覆蓋舊的使用日期。(第13頁)

\*<sup>1</sup> Filter replacement period may be shortened, depending on the environment (such as where smoking is frequent). Please replace it when ineffective.  
根據使用場所等實際情況(如吸煙人數較多的家庭),過濾網的更換週期可能會縮短。當過濾效果不好時請及時更換。

\*<sup>2</sup> The service life of the humidifying filter may vary with the water quality. In any one of the following cases, please replace it immediately.  
根據水質的不同使用壽命會有所變化,出現以下情況時請立即更換。

- After maintaining it, its odor is still not removed.  
清潔後也無法去除氣味。
- The water in tank is not reduced.  
水箱中的水沒有減少。
- It is seriously damaged.  
損傷嚴重。

#### Notice 提示事項

- The filter which needs to exchange cannot be used again even it is cleaned, please dispose the used filter as non-flammable garbage.  
達到更換週期的過濾網即使清潔乾淨也不可再使用,請將它作為不可燃垃圾處理。
- Do not discard the filter frame and filter plate when replacing the humidifying filter.  
更換加濕過濾網時,請勿扔掉過濾網框架及過濾網壓板。
- If the product is used in a room (especially hotel) with strong odor such as aromatic smell, cigarette smoke or barbecue smell, these odors may adhere to the filter. When the adsorption capacity of filter reaches saturation, odor will also be blown out again with the wind because of excess adsorption. When there is above situation, please clean the HEPA composite filter. If the situation persists, please replace the HEPA composite filter and deodorizing filter, even if the filter replacement indicator is off. In addition, if often used in a room with strong odor, please open the windows to ventilate the room regularly.  
如果在有芳香劑、香煙或烤肉等氣味濃烈的環境下(特別是酒店)使用,異味有可能會附著在過濾網上;當過濾網的吸附能力達到飽和後,氣味也會因吸附過盈而隨風再次被吹出。當發生以上情況時,請對HEPA多功能過濾網進行維護保養;若保養後仍有異味吹出,即使過濾網更換指示燈沒有亮起,也請對HEPA多功能過濾網和脫臭過濾網進行更換。另外,若經常在氣味濃烈的環境下使用,建議定期針對室內開窗進行通風換氣。

### When idle for a long time 長期間置時

1. Disconnect power plug after turning off the product. (The product still consumes power even at rest.)  
停止運轉產品,並拔出電源插頭。(因為停止運轉時也耗電。)
2. Please empty the tank and tray, and maintain the product.  
請倒掉水箱和水盤中的水,並對產品進行維護保養。
3. Dry the interior completely. (Otherwise, the product may be failed due to rust.)  
Dry the humidifying filter assembly in a cool place. (Anti-fungus)  
徹底擦乾內部。(否則因生鏽可能導致產品發生故障。)  
加濕過濾網組件要在陰涼處晾乾。(防霉)
4. Put the product into poly bag and carton, and keep it in a dry place.  
(If you overturn it or keep it flat, product malfunctions may occur.)  
放入塑膠袋和紙箱中,並存放於乾爽處。(倒置或平放可能會導致產品發生故障。)

# FURTHER INFORMATION

## 更多信息

### About nanoe® X 關於nanoe® X

#### ■ nanoe® X can be switched off.

nanoe® X 功能可關閉。

During operation, press **Econavi** and **Clean·Humid.** buttons at the same time for about 3 seconds to switch off. (nanoe® X indicator lights off)

Please press the buttons for about 3 seconds again to restart the nanoe® X.

在產品運轉狀態下，同時按下 **Econavi** 和 **Clean·Humid.** 按鈕約3秒即可關閉。(nanoe® X 指示燈熄滅)  
再次按下約3秒，可重新開啟nanoe® X 功能。

#### ■ Conditions for nanoe® X generation

nanoe® X 產生的環境條件

nanoe® X is generated by using the air in the room. Therefore, due to the differences in temperature and humidity nanoe® X may not be generated stably.

利用室內空氣產生，根據溫度和濕度的不同，有時可能無法穩定產生。

- Room temperature: about 5 °C ~ 35 °C (dew-point temperature: 2 °C or above)

室內溫度：約5 °C ~ 35 °C (露點溫度：2 °C 以上)

- Relative humidity: about 30% ~ 85%

相對濕度：約30% ~ 85%

#### ■ When nanoe® X is generated, small amount of ozone will be released. However, the quantity will be far less than the level in natural environment such as forest, and not be harmful to human beings.

產生nanoe® X 的同時，也會產生微量臭氧。但其產生量遠遠不及森林等自然界存在的臭氧量，不會對人體造成傷害。

### About HEPA composite filter 關於HEPA多功能過濾網

The HEPA composite filter which with the Bio-sterilization and Super Allergy-buster can inhibit allergens (pollen, dead mites and feces), bacteria and mold.

HEPA多功能過濾網中集成了生物除菌、抗過敏原，能夠抑制過敏原（花粉、蟎蟲屍體及糞便）、細菌、霉菌。

#### ■ Super Allergy-buster: inhibits the activity of allergens (pollen, dead mites and feces).

抗過敏原：抑制過敏原（花粉、蟎蟲屍體及糞便）的活動。

Testing authority: Osaka Municipal Technical Research Institute

檢測機構：大阪市立工業研究所

Test method: check the decrease of refined house dust mite allergen, by using enzyme immune measuring method.

檢測方法：通過酶免疫測定法確認精製塵蟎過敏原的降低。

Inhibiting method: contact with Super Allergy-buster

去除方法：與抗過敏原接觸

Target: allergens trapped by the filter (mites, pollen)

檢測對象：過濾網收集的過敏原（蟎蟲、花粉）

Test result: inhibited 99% and above. (Daikou research report No. 2127)

檢測結果：抑制99%以上。(大工研報第2127號)

#### ■ The HEPA composite filter may give off unique and harmless smell of "Green Tea Catechin", "Bio-sterilization" and "Super Allergy-buster".

HEPA多功能過濾網會散發出“綠茶兒茶素”、“生物除菌”以及“抗過敏原”特有的氣味，此氣味對人體無害。

#### ■ Removes $\geq 99.97\%$ \* of 0.3 $\mu\text{m}$ particles.

\*it's dust removing performance of filter itself, the effect in the entire room is not same.

粒徑0.3  $\mu\text{m}$  顆粒物的去除率達到99.97%\*。

\*這是過濾網的去除性能。與整個房間的去除性能不同。

Test No.: KJ20222781

Test Standard: JIS B 9908: 2011 Test method of air filter units for ventilation and electric air cleaners for ventilation

檢測報告號：KJ20222781

檢測標準：JIS B 9908: 2011 換氣用空氣過濾網組合·換氣用電氣集塵器的性能試驗方法

# FURTHER INFORMATION

## 更多信息

### About odor sensor/dirt sensor 關於異味感應器/灰塵感應器

The sensor can detect the pollution of the air, and show the pollution level by clean sign. The product can adjust the air volume according to the air pollution automatically and purify air by optimal air volume when the setting of "Full Auto", "Auto Vol.", "Auto Dir."

檢測空氣污染物，通過空氣污染度指示燈顯示污染程度。

當設定為“全自動”、“風量自動”、“立體循環氣流”時，根據空氣污染情況自動調節風量，以最佳的風量淨化空氣。

Sensor 感應器	Sensing scope 感應範圍	May detect 有可能感應
Odor sensor 異味感應器	<ul style="list-style-type: none"><li>Odor from cigarettes, incense, cooking, pets 香煙、香燭、烹飪、寵物的氣味</li><li>Cosmetics, alcohol, sprays, etc. 化妝品、酒精、噴霧劑類等</li></ul>	<ul style="list-style-type: none"><li>Humidity (water vapor), oil 蒸汽(水蒸汽)、油煙</li><li>The wind generated when a door is opened or closed, or sudden temperature changes 開關門時產生的風或急劇的溫度變化等</li></ul>
Dirt sensor 灰塵感應器	<ul style="list-style-type: none"><li>Indoor dust (dust, dead bodies and excreta of ticks, mold spores, pollens, etc.) 室內揚塵(灰塵、壁虱的屍體、排洩物、霉菌孢子、花粉等)</li><li>Smog (cigarettes, incenses, etc.) 煙(香煙、香火等的煙)</li></ul>	<ul style="list-style-type: none"><li>Oil, fog-stated water drip 油煙、霧狀的水滴</li></ul>

■ The sensor's operation may vary depending on the indoor airflow condition if a heater is placed near the product in a room.

在靠近加熱器的場所使用時因室內空氣的流動，感應器的工作狀況有可能會發生變化。

■ The sensor is not designed to detect bacteria and viruses.

不能夠感應細菌以及病毒。

■ The sensitivity of the sensor can be adjusted. (The default setting is "medium sensitivity".)

感應器的靈敏度可調節。(出廠設置為“中感應度”。)

① Stop operating the product, then press **Air Volume** and **Econavi** buttons at the same time for about 3 seconds. (The air volume indicators light on in turn.)

產品停止運轉的狀態下，同時按下 **Air Volume** 和 **Econavi** 按鈕約3秒。(此時指示燈依次亮起。)

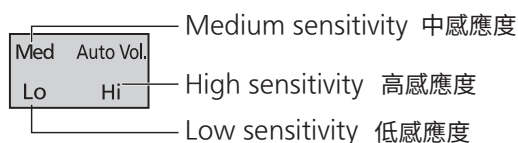

② Please release the buttons, when the sensitivity is set as required.

達到所需設置模式時，請鬆開按鈕。

### About Sleep Mode Auto Operation 關於睡眠自動運行模式

Detects the indoor brightness by the light sensor, and automatically adjusts the brightness of indicators on control panel and front indication, and the air volume.

When sleeping, the room becomes dark, the indicators will be dimmed or turn off and the air volume becomes low.

通過亮度感應器檢測室內亮度，自動調節操作面板和前方指示燈的亮度以及風量大小。

就寢時，室內變暗，指示燈變暗或熄滅，風量會變小。

#### Notice 提示事項

When the air volume is set to "Hi", "Med" or "Lo", the air volume cannot adjust automatically.

風量設置為“高速”、“中速”、“低速”時，不能自動調節風量。

# FURTHER INFORMATION

## 更多信息

■ “Sleep Mode Auto Operation” can be adjusted. (The default setting is “Sleep Mode Auto 1”.)  
 “睡眠自動運轉”模式可設置。(出廠設置為“睡眠自動1”)

① Stop operating the product, then press **Timer** and **Econavi** buttons at the same time for about 3 seconds. (The airflow indicators light on in turn.)

產品停止運轉的狀態下，同時按下 **Timer** 和 **Econavi** 按鈕約3秒。(此時指示燈依次亮起。)

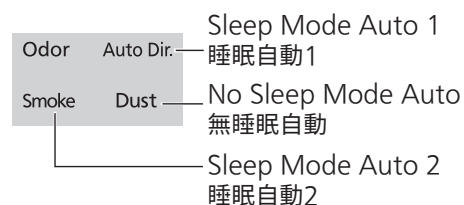

② Please release the buttons, when the sensitivity is set as required.  
 達到所需設置模式時，請鬆開按鈕。

Mode 模式	Indicators 指示燈	Indoor brightness 室內亮度	
		Dim 微暗	Dark 暗
Sleep Mode Auto 1 睡眠自動1	Control panel 操作面板	No change 燈不變	Light low level 燈微亮
	Front indication panel 前方指示燈面板	Light low level 燈微亮	Light off 燈熄滅
Sleep Mode Auto 2 睡眠自動2	Control panel 操作面板	No change 燈不變	Light low level 燈微亮
	Front indication panel 前方指示燈面板	Light low level 燈微亮	Light low level 燈微亮
No Sleep Mode Auto 無睡眠自動	Control panel 操作面板	No change 燈不變	No change 燈不變
	Front indication panel 前方指示燈面板	No change 燈不變	No change 燈不變

## About Econavi 關於Econavi

Econavi mode refers to the automatic operation by combining the “patrol mode” in which the product detects the dirt in the air in the room every hour with the “learning mode” in which the product can forecast the dirt generation by mastering the generation time of dirt every day.

Automatically stops operating when the clean air is detected, meanwhile it also operates in advance to eliminate the dirt effectively before spreading, thus reducing the operation time and saving power.

Econavi是指每小時檢測房間內空氣污染物的“偵測模式”和通過掌握每天污染物產生時間的規律，在污染擴大之前先行運轉產品的“學習模式”共同組合而成的自動運轉。

檢測到空氣潔淨時，自動停止運轉，同時通過先行運轉，在污染擴大前進行有效清除從而縮短執行時間節省電力。

### Patrol mode 偵測模式

The product will stop operating automatically after the air is cleaned. After the operation is paused for 55 mins, the product will operate for 5 mins with air volume set to “Med” in the patrol mode.

空氣變潔淨後會自動停止運轉。運轉中止55分鐘後，以中速風量運轉5分鐘偵測模式。

- While the operation is paused and in the patrol mode, if any dirt is detected, the product will operate with the air volume corresponding to the dirtiness.

在運轉中止及偵測模式期間，若檢測到污垢時將以最佳的風量進行運轉。

- When under the setting of “Full Auto” or “Clean/Humid.”, the product will also operate according to the indoor humidity even if the indoor air is clean.

在“全自動”、“加濕空氣淨化”設置情況下，即使室內空氣潔淨，也會根據室內濕度運轉。

- When the operation is paused, and there is no people in the room, the front indication will be off. If someone in the room, but there is no detection for human activity sensor, the front indication also will be off.

運轉停止時，若室內無人，前方指示燈會熄滅。若室內有人，但人體感應沒有進行檢測的情況下，前方指示燈也會熄滅。

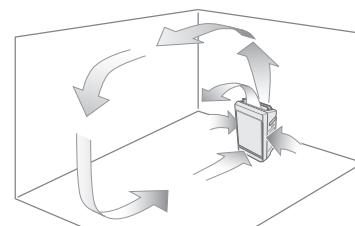

# FURTHER INFORMATION

## 更多信息

### Learning mode 學習模式

The product records the time and dirtiness of air during operation, and takes the preventive operation 5 mins before the recorded dirt is generated in the next day. (Although the records are updated every day, the previous records will be lost once the power plug is disconnected.)

記錄運轉過程中空氣污濁的時間段以及污濁程度，次日將在所記錄的污濁產生時間前5分鐘進行預防運轉。  
(記錄每日更新，但是拔出電源插頭後之前的記錄會全部消除。)

### About airflow 關於空氣流動

The louver and front panel move to the best position according to the type and degree of dirt, and thus the product will operate.

根據室內污染物種類和污染程度，導風板和前面板移動到最佳位置，進行運作。

#### Auto Dir. 立體循環氣流

The product uses the airflow function separately according to the type of dirt in the air, to achieve a good dirt-removal effect.

按照空氣污染的種類，自動選擇不同的氣流運轉方式，達到較好的除塵效果。

■ Status of air dirt and functions of the louver and front panel.  
空氣污濁狀態和導風板以及前面板的功能。

Air quality 空氣污染狀況	Clean sign 空氣污染度 指示燈	Functions of the louver 導風板的功能	Functions of the front panel 前面板的功能	Figure 插圖
Clean status 清潔狀態	Blue 藍色	Switch direction 擺動	Closed 關閉	(A)
Odor and smog are detected 檢測到異味或煙霧	Red 紅色	Upward 向上	Open frontward 向前方打開	(B)
House dust is detected 檢測到室內揚塵	Red 紅色	Front 前方	Open upward 向上方打開	(C)
Odor or smog and house dust are detected 同時檢測到異味或煙霧和 室內揚塵	Red 紅色	Switch direction 擺動	Open upward 向上方打開	(D)

#### To operate manually 手動操作時

##### Odor and smog 異味和煙霧

The whole front panel absorbs odor and smog floating in the air effectively. When people smoke or cook, the odor and smog are removed together. (Figure (B))  
通過整個前面板有效吸收漂浮在空氣中的異味和煙霧。吸煙時以及烹飪時，想集中去除氣味和煙霧。(插圖 (B))

##### House dust 室內揚塵

The lower part of the front panel absorbs house dust such as pollens easy to accumulate around the floor. In the pollen season, especially when there is house dust. (Figure (C))  
通過前面板下方有效吸收容易積存在地板周圍的花粉等室內揚塵。在花粉季節，特別在意室內揚塵時。(插圖 (C))

#### Notice 提示事項

■ When the air volume is set to "Hi", the product will operate with the front panel open.

當風量設置為高速時，產品將以前面板打開狀態運轉。

■ The product will operate with the front panel open after operating for 10 minutes.

開始運轉後10分鐘，產品將以前面板打開狀態運轉。

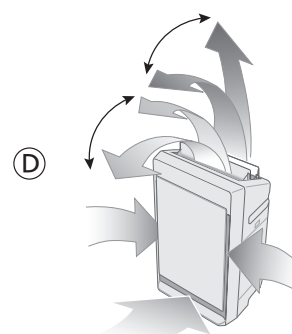
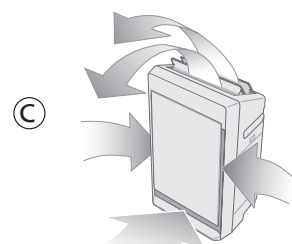
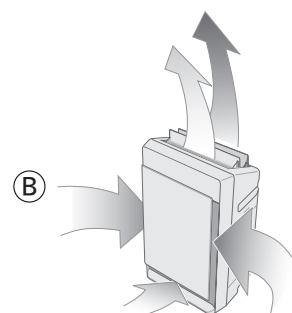
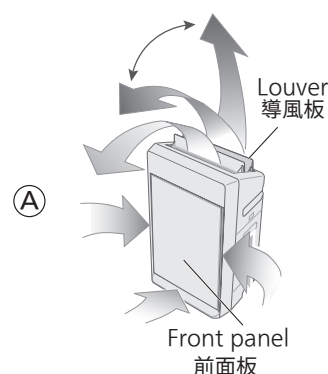

# FAQ

## 常見問題解答

Please confirm the following before you put questions forward or send the product for repair.  
諮詢或送去維修之前，請先確認以下情況。

**Q1** Why is the wind cold during humidifying?  
加濕過程中，為什麼風較冷？

**A**

When operating in "Humidifying mode" or "Humidifying auto mode", the product will blow out the wind below the room temperature since the moisture from the humidifying filter containing water absorbs the heat in the air.

“加濕模式”、“自動加濕模式”運轉時，因為濕氣從含水的加濕過濾網散發出來會吸收空氣中的熱量，所以吹出比室溫低的風。

**Q2** Why is there no steam during humidifying?  
加濕過程中，為什麼無蒸汽？

**A**

This product is just to make the humidifying filter containing water generate moisture when encountering wind but not boil the water, and hence not generate the steam. 此並非使水沸騰的方法，而是採用含水的加濕過濾網遇風而產生濕氣的方法，因此不會產生蒸汽。

**Q3** Why is the humidifying amount reduced?  
加濕量為什麼較少？

**A**

In the rainy season with high humidity or in the cold weather, the humidifying amount may change, depending on the room temperature and humidity, just as the washed clothes are difficult to dry. The humidifying amount will increase when the weather is warm and dry.

與在梅雨季節濕度較高時以及寒冷的天氣，衣服不易晾乾原理相同，根據房間的溫度和濕度不同加濕量會有所變化。溫暖、乾燥的時候加濕量將增多。

**Q4** Why is there dewing on the window and wall?  
窗戶以及牆壁為什麼會結露？

**A**

Even if the humidity in the room is moderate, there may be dewing on a cold window or wall.

即使房間濕度適中，在溫度較低的窗戶以及牆壁等上也會發生結露。

**Q5** Why is a "jee" sound from the emission outlet?  
出風口為什麼發出“噠”的聲音？

**A**

There is a slight sound when nanoe® X is being generated. Depends on the environment and operation mode, the sound may be a bit loud or inaudible but it is not abnormal.

產生nanoe® X時，將發出些許聲音。根據使用環境、運轉模式不同，聲音的大小有所不同，這並非異常。

**Q6**

Why does the color of humidifying filter change?  
加濕過濾網為什麼變色？

**A**

The filter may change in color depending on the water quality. This is not a performance problem.

根據水質的不同有可能發生變色，並非性能上的問題。

**Q7**

Why does the humidity indicator remain red?  
濕度指示燈為什麼一直顯示為紅色？

濕度指示燈為什麼一直顯示為紅色？

30 Humidity indicator (%) 70  
or less 40 50 60 or more

Humidity indicator  
濕度指示燈

■ The indicator **70 or more** is always on.

濕度指示燈 **70 or more** 一直亮起。

The product may not sense the humidity properly depending on the setting place.

放置場所不同，存在無法正確感知濕度的情況。

→ Change the setting place.  
改變放置場所。

■ The indicator **30 or less** is always on.

濕度指示燈 **30 or less** 一直亮起。

The room size is too large for the product?

房間的大小是否過大？

→ Refer to the applicable room size.  
(P.35)

請參考適用面積。(第35頁)

**A**

### Notice 提示事項

■ Please use the humidify sign only as a reference.

請將濕度指示作為參考。

■ It is different from the display of the household hygrometer sometimes.

有時與家庭用濕度計的顯示值不同。

■ The humidity value will vary with the temperature.

根據溫度的變化，濕度值會產生變化。

■ The humidity may also vary with the airflow condition.

空氣流通情況不同，濕度也會不同。

# FAQ

## 常見問題解答

Q8

Why does the clean sign not change or why is the front panel always opened?  
空氣污染度指示燈為什麼不發生變化？為什麼前面板一直是打開狀態？

A

Such problems may occur because of the difference in sensitivity of sensor. (P.27)  
因感應器靈敏度差異影響可能出現此現象。(第27頁)

Q9

To disable the human activity sensor. (Change the sensor sensitivity)

想關閉人體感應器時。(改變感應器靈敏度)

The sensitivity of the sensor can be adjusted.

感應器的靈敏度可調節。

(The default setting is "Standard sensitivity".)

(出廠設置為“標準靈敏度”)

① Stop operating the product, then press **Air Volume** and **Airflow Dir.** buttons at the same time for about 3 seconds.

(The clean/humidifying indicators light on in turn.)

產品停止運轉的狀態下，同時按下 **Air Volume** 和 **Airflow Dir.** 按鈕約3秒。(此時空氣淨化/加濕指示燈依次亮起。)

A

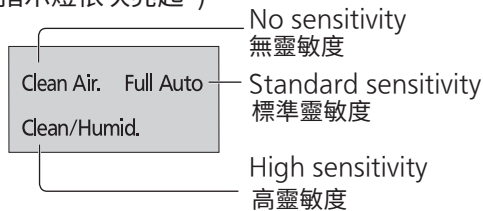

② Please release the buttons, when the sensitivity is set as required.

達到所需設置模式時，請鬆開按鈕。

Q10

Why is the human activity sensor indicator always on without people or pets moving?

為什麼人或寵物沒有活動，人體感應指示燈一直點亮？

A

When you use an electric room heater with swing function, if the indoor temperature changes, the sensor could automatically function even if nobody is moving.

使用擺動功能的電暖氣時，如果室內溫度發生變化，人即使沒有動也可能會自動感應。

Q11

Why is the human activity sensor indicator off?

為什麼人體感應指示燈不亮？

■ The human activity sensor does not operate within 2 minutes after the power supply is connected.

接通電源2分鐘內，人體感應器不運轉。

■ The human activity sensor does not take effect beyond the detectable area or when it is blocked by furniture.

人體感應的感應範圍外，或者有家具等阻擋的情況下無法感應。

■ The human activity sensor may fail to function when the body temperature is the same as the ambient temperature.

人體溫度與周圍溫度無差異的情況下，有可能無法感應。

■ Is the human activity sensor stained?

→ Use a dry cotton swab to clean it.

人體感應器是否髒污？

使用干棉棒清理髒污。

A

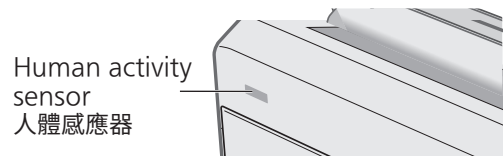

Q12

During operation, indicators on front indication panel are off.

運轉過程中，前方指示燈面板上的指示燈為什麼熄滅了？

■ Detects the indoor brightness, and switches the brightness of indicators automatically with the "Sleep Mode Auto Operation" function. (P.28)

通過“睡眠自動運行模式”功能檢測室內亮度並自動調節指示燈亮度。(第28頁)

■ When the patrol mode of Econavi operation is paused, and there is no people action detected by human activity sensor, the indicators will be off. (P.28)

當Econavi偵測模式運轉停止，人體感應器沒有檢測到人體活動時，指示燈會熄滅。(第28頁)

A

Q13

To turn off the indicators on front indication panel.

想關閉前方指示燈面板上的指示燈時。

■ Please press **Air Volume** and **Clean·Humid.** buttons at the same time for about 3 seconds during operating to turn off the indicators.

想關閉指示燈時，在運轉過程中同時按下

**Air Volume** 和 **Clean·Humid.** 按鈕約3秒。

■ Please press the buttons for 3 seconds again to relight the indicators.

再次按下按鈕約3秒，指示燈重新亮起。

A

# TROUBLESHOOTING

## 故障排除

If a problem is encountered, investigate it by going through the following items.

If the problem still persists, please disconnect the power plug and contact the dealer for repair.

首先請確認以下內容，執行此操作後仍無法修復，請拔下電源插頭，並聯繫經銷商進行檢查、維修。

Possible situation 可能發生的狀況	Please confirm the following 請確認以下內容
① Clean sign remains red even when the operation continues. 即使是持續運轉，空氣污染度指示燈一直為“紅色”	<ul style="list-style-type: none"> <li>■ The indicator may illuminate red when the product is subject to steam in the bathroom or vapor emitting from sprayers. 受到浴室等熱氣、噴霧產生的氣體影響，指示燈可能會變紅。</li> <li>■ When sand flies off. 沙塵較多的場合。</li> <li>■ Is the dirt sensor dirty? (P.24) 灰塵感應器是否髒污？(第24頁)</li> </ul>
② Automatic operation cannot be stopped 自動運轉無法停止	<ul style="list-style-type: none"> <li>■ Under the settings of “Clean Air.”, “Auto Vol.”, the product will also operate by low air volume even if the air in the room is clean. “空氣淨化”、“風量自動”運轉時，即使室內空氣潔淨也會以低風量運轉。</li> <li>■ Under the setting of “Full Auto” or “Clean/Humid., Auto Vol”, the product will also operate according to the indoor humidity even if the air in the room is clean. “全自動”、“加濕空氣淨化·風量自動”運轉時，即使室內空氣潔淨，產品也會根據室內濕度運轉。</li> </ul>
③ Clean sign remains blue even when the air is dirty. 空氣有污濁，但空氣污染度指示燈顯示仍為“藍色”	<ul style="list-style-type: none"> <li>■ Is the product placed in area where polluted air is difficult to be cleared? (P.7, P.35) 請確認產品是否在污染物難以吸入機體的場所使用？(第7頁、第35頁)</li> <li>■ Is the dirt sensor dirty? (P.24) 灰塵感應器是否髒污？(第24頁)</li> </ul>
④ Polluted air is difficult to be removed 難以去除空氣中的污物	<ul style="list-style-type: none"> <li>■ Is the HEPA composite filter dirty? (P.24) HEPA多功能過濾網是否髒污？(第24頁)</li> <li>→ Clean it. If the situation persists, replace the filter with a new one. 維護保養後仍然無改善時，則更換新的過濾網。</li> </ul>
⑤ There is sound 有響聲	<ul style="list-style-type: none"> <li>■ When the humidifying filter assembly is operating, the water drips may drop sometimes. This is normal. 由於加濕過濾網組件轉動運轉，偶爾會有水滴落下的聲音，屬正常現象，並非異常。</li> <li>■ It is water dripping sound when flowing and falling from the tank. This is normal. 水從水箱流動落下時，有可能產生“滴滴”聲，屬正常現象，並非異常。</li> <li>■ After pressing <b>Power Off/On</b>, <b>Airflow Dir.</b> or <b>Spot.Air</b> button, you may hear some sound around the front panel and louver. This is normal. 按下 <b>Power Off/On</b>，<b>Airflow Dir.</b> 或 <b>Spot.Air</b> 按鈕時，在前面板以及導風板附近可能會聽到聲響，屬正常現象，並非異常。</li> <li>■ Have the claws been installed onto the 6 positions of the filter fixing frame of the humidifying filter kit? (P.23) 加濕過濾網組件的過濾網框的6個掛鉤是否安裝到位？(第23頁)</li> </ul>





# TROUBLESHOOTING

## 故障排除

Possible situation 可能發生的狀況	Please confirm the following 請確認以下內容
⑥ The air volume is small 出風量少	<ul style="list-style-type: none"> <li>■ Is the HEPA composite filter or humidifying filter dirty? (P.23~24) HEPA多功能過濾網或加濕過濾網是否髒污? (第23~24頁)</li> <li>→ Clean it. If the situation persists, replace the filter with a new one. 維護保養後仍然無改善時,則更換新的過濾網。</li> </ul>
⑦ The odor from the product is unpleasant 產品的氣味讓人感覺不適	<ul style="list-style-type: none"> <li>■ Is the body, front panel or HEPA composite filter dirty? (P.24) 機體、前面板、HEPA多功能過濾網是否髒污? (第24頁)</li> <li>→ Clean it. If the situation persists, replace the filter with a new one. (The harmful carbon monoxide generated by cigarette cannot be removed) 如果清潔後仍無改善,則更換新的過濾網。 (本產品不能去除香煙中的一氧化碳。)</li> <li>■ Has the product ever been used in a room with strong odor? If the product is used in a room with strong odor such as aromatic smell, cigarette smoke or barbecue smell, the filter replacement period may be shortened. 在濃烈氣味的房間內使用過嗎?如果在有芳香劑、香煙、烤肉或濃烈氣味場所中使用,可能會縮短過濾網的使用週期。</li> <li>→ If you use the product in such environments, it is recommended to open the air ventilation system or open the windows to ventilate the room at the same time. If there is still strong odor to be blown out after the maintenance, please replace the HEPA composite filter and deodorizing filter, even if the filter replacement indicator does not light on. 在這種環境下使用時,建議同時打開房間的換氣系統或適當開窗通風。若維護保養後仍有異味出吹,即使過濾網更換指示燈沒有亮起也請更換HEPA多功能過濾網和脫臭過濾網。</li> <li>■ Is the tank, tray or humidifying filter dirty? (P.21~23) 水箱、水盤及加濕過濾網是否髒污? (第21~23頁)</li> <li>■ Is the water in the tank replaced with new tap water every day? 是否經常更換水箱裡的水?</li> <li>■ When under the setting of "Clean Air.", please empty the water in tray and tank. 空氣淨化模式運轉時,請倒掉水箱及水盤中的水。</li> </ul>
⑧ The water amount in the tank is not reduced, and the product does not humidify, but the operation indicator is on. 水箱水量不減少,且不加濕,但運轉指示燈為亮起狀態	<ul style="list-style-type: none"> <li>■ Is the humidifying filter dirty? (P.23) 加濕過濾網是否髒污? (第23頁)</li> <li>■ Is the tray fit into the interior of the product? 水盤有無安裝到位(安裝直至底部)?</li> <li>■ Is the humidifying filter installed properly? (P.23) 加濕過濾網安裝是否正確? (第23頁)</li> <li>→ When the humidifying is installed incorrectly, the product will sound abnormally, and not humidify. 安裝不正確時,可能會發出異常聲響,以及不加濕。</li> <li>■ Is the anti-fungus assembly installed properly? (P.22) 防霉組件是否安裝正確? (第22頁)</li> <li>■ The product will stop humidifying when reach the set humidity. (At this time, if the air in the room is clean, the louver will close and the product enters the standby mode.) 達到設定的濕度後產品會停止加濕。 (此時,若房間內空氣潔淨,導風板會關閉,產品進入待機模式。)</li> </ul>
⑨ The humidity does not increase 濕度不增加	<ul style="list-style-type: none"> <li>■ Is the room ventilated, or has laid the carpet onto the floor? 是否進行了通風換氣,地板上是否鋪有地毯?</li> <li>→ If there is floor carpet, the humidity may be difficult to increase sometimes, depending on the specific ventilation, floor and wall material. 鋪有地毯時,根據通風狀態、地板以及牆壁材質的不同,有時濕度可能難以提升?</li> <li>■ Is the room size too large for the product? (P.35) 請確認產品是否在面積太大的場所使用?(第35頁)</li> </ul>

# TROUBLESHOOTING

## 故障排除

Possible situation 可能發生的狀況	Please confirm the following 請確認以下內容
⑩ There is condensation inside the tray 水盤內側有結露	<ul style="list-style-type: none"> <li>■ After the product stops operation or when the room is cold, there may be condensation. This is normal. 停止運轉後以及房間較為寒冷時，有可能會發生結露，屬正常現象並非異常。</li> </ul>
⑪ The water fill indicator is blinking or lights on 加水指示燈閃爍或亮起  	<ul style="list-style-type: none"> <li>■ Is the tank filled with water? 水箱中是否已加水？</li> <li>→ If you want to humidify, please fill water into the tank? (P.15) 需繼續加濕時，請向水箱中加水。(第15頁)</li> </ul>
⑫ Even if there is water in the tank, the water fill indicator is still blinking or lights on 水箱中有水，但加水指示燈閃爍或亮起	<ul style="list-style-type: none"> <li>■ Is the tray fit into the interior of the product? 水盤有無安裝到位(安裝直至底部)？</li> <li>■ Is the product tilted? 產品是否傾斜了？</li> <li>→ Please place the product on the level and stable table or floor. 請將產品設置在水平且平穩的檯面或地面上。</li> </ul>
⑬ The check indicator is on 檢查指示燈亮起  	<ul style="list-style-type: none"> <li>■ Is the product overturned? 產品是否翻倒了？</li> <li>→ ① Disconnect the power plug. 拔出電源插頭。</li> <li>② Erect the product. (Wipe the water off it) 扶起產品。(擦掉附著的水)</li> <li>③ Keep the product idle for half a day. (Doing this is to dry the product thoroughly in case water drops into the product.) 停置半日以上不使用。(倘若內部進水，停用半天可以完全晾乾。)</li> <li>④ Power the product on again, and it will operate. 再次接通電源，開始運轉。</li> <li>■ Have you applied actions such as shaking, tilting and impacting onto the product? 是否對產品施加搖晃、傾斜、撞擊等動作？</li> <li>→ Disconnect the power plug, and then reinsert the power plug. 拔出電源插頭，再重新插上。</li> <li>■ Do you put any magnet or metal objects on the product? (P.7) 產品上是否放置了磁鐵或金屬物品？(第7頁)</li> <li>→ Take away the objects, and disconnect the power plug, then reinsert the power plug. 拿開物品，拔出電源插頭，再重新插上。</li> </ul>

If any of the following cases occur, please contact the dealer immediately for repair.  
如遇以下情況，請立即聯繫經銷商進行維修。

The check indicator is on, and all the air volume indicators are blinking 檢查指示燈亮起，風量指示燈閃爍	<ul style="list-style-type: none"> <li>■ Product may be out of order. 產品可能發生故障。</li> <li>→ Please disconnect the power plug and contact the dealer for repair. 請拔出電源插頭，聯繫經銷商進行維修。</li> </ul>
--	--

# WHEN THE LOUVER SHIFTS

## 導風板移位時

### How to install the louver 導風板的安裝方法

**1** Insert the concave projection of the louver (front) into the square hole.

把導風板(前)的凹形突出部插入方形孔。

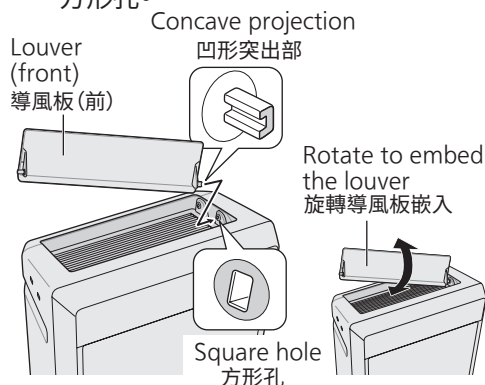

**2** Slightly bend the middle of louver, and insert the other side into the other hole.

稍微彎曲導風板中部，將另一端插入圓形孔。

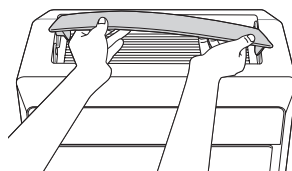

**3** Insert the louver (back) in the same way.

導風板(後)也用同樣的方法安裝。

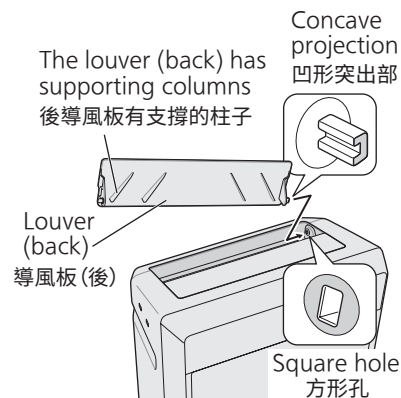

#### Notice 提示事項

Do not mistake the installation of the louvers (front and back).  
請勿錯誤安裝前導風板和後導風板。

## SPECIFICATIONS

### 規格

Model No. 型號	F-VXV70H					
Power supply 額定電壓・頻率	220 V~ 50 Hz					
Operation mode 運轉模式	Clean Air 空氣淨化			Clean/Humid. 加濕空氣淨化		
Air volume settings 風量模式	Hi 高	Med 中	Lo 低	Hi 高	Med 中	Lo 低
Power consumption (W) <sup>*1</sup> 消耗功率 (W) <sup>*1</sup>	66	11	6	58	15	10
Humidifying amount (mL/h) <sup>*2</sup> 加濕量 (mL/h) <sup>*2</sup>	— <sup>*3</sup>	— <sup>*3</sup>	— <sup>*3</sup>	700	400	250
Air volume (m <sup>3</sup> /min) 風量 (m <sup>3</sup> /min)	6.7	2.7	1.1	6.3	3.1	1.9
Floor area capacity 適用面積	Up to 52 m <sup>2</sup> in a standard household room <sup>*4</sup> 普通家庭，最大適用面積52 m <sup>2</sup> <sup>*4</sup>			Up to 32 m <sup>2</sup> in a standard household room <sup>*5</sup> 普通家庭，最大適用面積32 m <sup>2</sup> <sup>*5</sup>		
Capacity of the tank 水箱容量	About 3.5 L 約3.5 L					
Power cord length 電源線長度	2.0 m					
Product dimension 產品尺寸	398 mm x [245 mm+(Foot:20 mm)] x 636 mm (W x D x H) 398 mm x [245 mm+(腳部:20 mm)] x 636 mm (寬×深×高)					
Product weight 產品重量	10.2 kg					

# SPECIFICATIONS

## 規格

- ※1 The power consumption is about 0.8 W when the operation is set to "Off".  
(With the power plug inserted.)  
運轉狀態為“關”時的耗電量為0.8 W。(插上電源插頭的狀態)
- ※2 Humidifying amount in the above table tested under the condition of high speed, room temperature 20 °C and humidity 30%. The humidifying amount may vary with the indoor temperature and humidity.  
加濕量是在高速、室內溫度約20 °C，濕度約30%條件下的測試值。根據室內溫度及濕度的不同，加濕量會有所變化。
- ※3 If there is water in tank, the product uses the water to humidify a little.  
(The water in the tank will be reduced little)  
水箱有水狀態下，產品會進行少量加濕。(水箱中的水會減少些許)
- ※4 Floor area capacity is based on JEM1467, under the condition of high speed operation.  
(Japan Electrical Manufacturers' Association)  
適用面積依據JEM1467，在高速運轉的狀態下測定。(日本電機工業協會標準)
- ※5 Floor area capacity is based on JEM1426, under the condition of high speed operation.  
(Japan Electrical Manufacturers' Association)  
適用面積依據JEM1426，在高速運轉的狀態下測定。(日本電機工業協會標準)

Note: This product cannot remove hazardous substances such as carbon monoxide from the cigarette smoke.

注：本產品不能去除香煙中的一氧化碳。

# OPTIONAL ACCESSORIES

## 自選配件

■ Replacement HEPA composite filter  
更換用HEPA多功能過濾網

Part No.: F-ZXKP70Z  
型號：



■ Replacement deodorizing filter  
更換用脫臭過濾網

Part No.: F-ZXFD70Z  
型號：



■ Replacement humidifying filter  
更換用加濕過濾網

Part No.: F-ZXKE90Z  
型號：

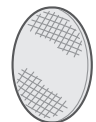

Without filter frame and filter plate  
不附帶過濾網框架和過濾網壓板

## Call the dealer 出現下列情況時，請聯繫經銷商進行維修

- The check indicator is on, and all the air volume indicators are blinking.  
Product may be out of order. Please disconnect the power plug and contact the dealer for repair.  
檢查指示燈亮起，風量指示燈全部閃爍。  
產品可能發生故障。請拔出電源插頭，聯繫經銷商進行維修。

Panasonic Corporation

Web site: <http://www.panasonic.com>

© Panasonic Corporation 2022

Issue date: 12/2022  
發行日期: 12/2022  
P1222-0 VXV7H8950