

- 6 - A free length of "EARTH" wire which must be longer than the "LIVE" and "NEUTRAL" wires and of at least 600 mm, must be provided to ensure Earth continuity in the event of mounting failure of the unit.
- This free length of "EARTH" wire must be measure from the "Anchor point" to the "Fan body" to ensure that the "EARTH" wire remains intact even after mounting failure and when the "Safety Wire" is in operation.
- 通常“地”(EARTH)線一定長過“火”(LIVE)線與“中”(NEUTRAL)線至少 600 mm，這將使“地”(EARTH)線產生其作用，如果本機不幸失常而墮下。
- 這條“地”(EARTH)線的長度測量法將從安全線螺絲至本機體，這將確定如果固定座失效或鬆掉而“地”(EARTH)線將發揮其作用仍然綁於天花牆上。

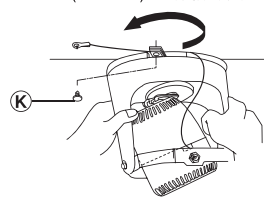

7 Tighten the set screw (K).
擰緊固定螺絲 (K)。

- Be sure to tighten the set screw; otherwise the unit will drop.
注意:
- 請肯定的已經裝上固定螺絲然後綁緊，不然本機會墮下。

WARNING
警告



Prohibited
禁止



Do not tangle motor lead with power cord.
不要讓馬達電線和電源線糾纏在一起。

HOW TO INSTALL THE REGULATOR / 安裝速度調節器之順序

CAUTION / 注意

This must be a double pole switch with minimum 3mm contact gap in the fixed installation circuit. "Double Pole" 型必須裝配，在安裝線於最低 3mm 間隙接點。

- 1 Disassemble as follows.
Use a Philips screwdriver to remove the cover set screw.
拆卸程序
用螺絲批把外殼固定螺絲鬆出。

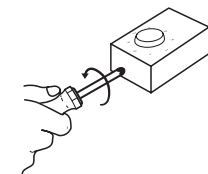

- 2 Fix the regulator base on the wall.
將調整器底殼安裝在牆上。

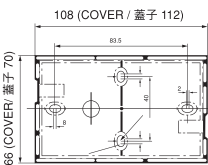

- 3 Ensure that the wiring follow wiring diagram.
確保接線按照接線圖連接。

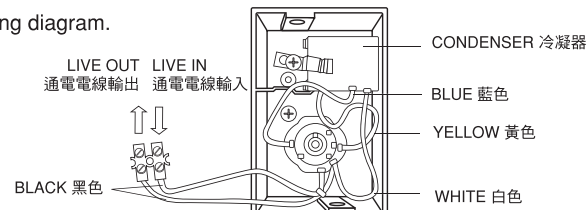

- 4 Reassemble in the reverse of the step 3 above.
倒置程序 3 的次序，重新裝配。

WIRING DIAGRAM 結線圖

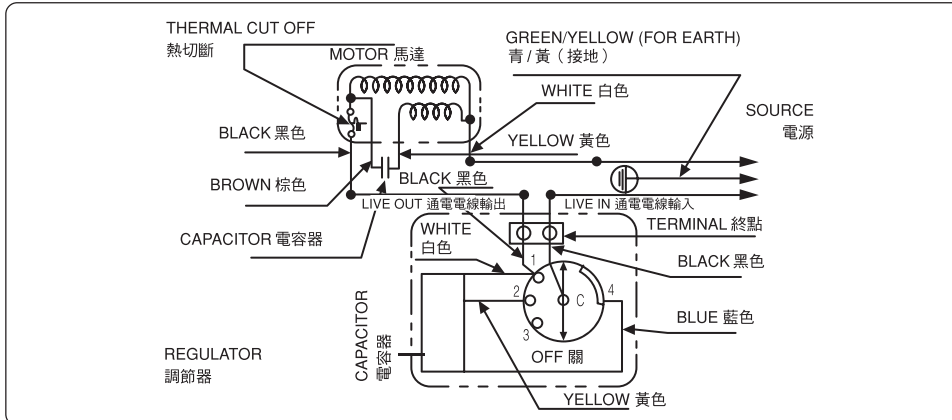

CAUTION / 注意



This product is not provided with cord and plug with other means for disconnection from the supply. When connect or change the power cord or lead wire, it must be performed by qualified personnel in order to avoid a hazard. Please use 227IEC53 (RVV) or thickness of tube is 1mm or above. (Other requirements such as diameter of lead wire, please use according to the regulation of the country). This product should be installed with a double poles single throw switch (Breaker Switch) with a minimum 3mm contact gap in the fixed installation circuit.

此產品沒有提供電纜和插頭或其他用作接駁電源的附件。當連接或替換電纜或電線時，這項工作必須交由能勝任的人員執行以防危險。請使用 227IEC53 (RVV) 或厚度超過 1 毫米的導管。(其他要求，例如電線直徑等等，請遵守相關國家的條例)。此產品必須在固定安裝電路上裝上觸點間隙為最少 3 毫米的雙極單投開關 (斷路開關)。

OPERATION / 使用要領

SPEED CONTROL / 速度控制

Rotary switch control
旋轉式開關型

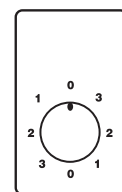

- To turn on the fan, simply turn the switch knob to any positions (1, 2, or 3). To turn it off, turn the switch knob to the (0) position.
- 使用時把開關旋鈕轉到 (1, 2 或 3) 位置。轉回 (0) 位隨即關閉。

ADJUSTMENT OF CIRCULATING ANGLE / 旋轉角度之調整

The oscillation angle can be adjusted to 15, 30 or 50 degrees.
擺動弧可以調整 15、30 或 50 度。

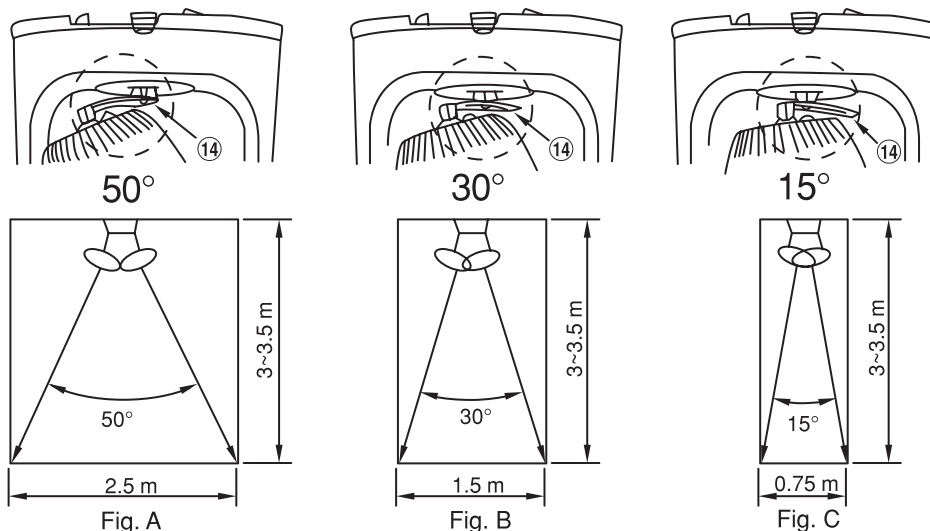

Note

This model is without plug because it is permanently connecting to fix wiring and mounting on the ceiling.
(This model to be installed by contractor.)

备注

由於此產品永久接駁於固定電路及安裝於天花，所以不提供電插頭。
(此產品應由承建商負責安裝。)

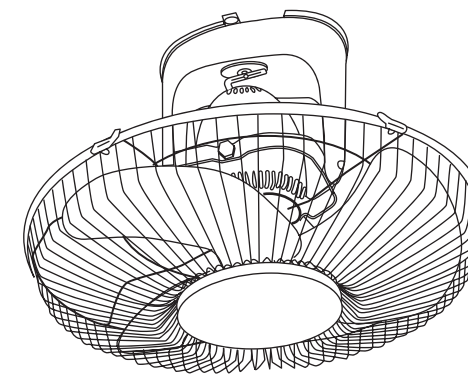

Net Weight / 淨重 : 4.1 kg

Panasonic

Electric Fan (Cycle Fan)
電風扇 (循環式風扇)

Model No. 型號

F-405QH

Operating Instructions

使用說明書

SPECIFICATION / 規格

VOLTAGE (V)	FREQ. (Hz)	POWER (W)
220 - 240	50	47.5 - 54.5
VOLTAGE (V)	FREQ. (Hz)	AIR DELIVERY (m ³ /min)
220	50	78

Before operating this set, please read these instructions completely.
使用前務請詳細閱讀本書所載事項。

Do not use power supply other than rated voltage mentioned.
切勿使用本文指定的額定電壓以外的電源。

If the supply cord is damaged, it must be replaced by the manufacturer, its authorized dealer or similarly qualified persons in order to avoid a hazard.
如果電源線已損壞，必須由製造商、授權經銷商或相關合格人員更換，以免發生危險。

Switch off power supply and wait until the Blade is fully static, before cleaning or doing any maintenance jobs.
清掃或進行任何維修工作前，關閉所有電源並等待扇翼完全靜止。

This appliance is not intended for use by persons (including children) with reduced physical, sensory or mental capabilities, or lack of experience and knowledge, unless they have been given supervision or instruction concerning use of the appliance by a person responsible for their safety. Children should be supervised to ensure that they do not play with the appliance.
除非由安全監護人就本產品進行監督或指導，否則身體、感官或智力有功能障礙者，或者缺乏相關經驗和知識的人士 (包括兒童) 請勿使用本電器。為了確保年幼的小孩不玩此電器，它們該受到監督。

To avoid the possibility of causing injury to users or damage to properties, please follow all the explanation written in this manual. The manufacturer will not be responsible for any accidents and injuries caused by defective, deficient installation or installation which does not follow to instruction manual.
為避免導致用戶受傷或財物損壞的可能性，請遵守本說明書內的所有指示。製造商對任何因不正確的安裝或不按照說明書指示的安裝所造成的任何意外和損傷將不負任何責任。

Thank you for purchasing this product.
感謝您選購此產品。

Panasonic Corporation
Web Site: <http://panasonic.net>



400QS80010M

ASSEMBLE AND INSTALLATION INSTRUCTION / 組合及安裝指示

- WARNING:** If unusual oscillating movement is observed, immediately stop using the fan and contact the manufacturer, its service agent or suitably qualified persons.
警告: 如果發生異常擺動,請立即停止使用風扇並聯絡製造商、其服務代理商或合適的有資格人員。
 - The replacement of parts of the safety suspension system device shall be performed by the manufacturer, its service agent or suitably qualified persons.
安全懸掛系統裝置部件的更換應由製造商、其服務代理商或合資格人員進行。
 - Installation and wiring should be done by dealer or authorized person.
安裝及接駁電線應由分銷商或指定人員負責。
 - Ensure that the fixing means for attachment to the ceiling such as hooks or other devices shall be fixed with a sufficient strength to withstand 10 times the weight of fan.
確保連結天花板的固定裝置例如鉤子或其他裝置,應以足夠的強度固定以承受 10 倍風扇的重量。
- CAUTION / 注意**
- This fan is specially design for mounting above 2.3 m from the floor. (Mounting height shall be 2.3 m)
這架風扇是特別設計用作安裝在離開地面 2.3 米的高度。(安裝高度是 2.3 米)
 - The mounting of the suspension system shall be performed by the manufacturer, its service agent or suitably qualified persons.
確保懸掛系統的安裝由製造商、其服務代理商或合適的有資格人員進行。
 - The fan suspension system should be examined at least once every two years.
建議每兩年至少檢查風扇懸掛系統一次。

CLEANING AND MAINTENANCE / 清洗和維修



Switched off
關閉

Ensure that the fan is switched off from supply main before cleaning or maintenance.
進行清洗或維修前必須先確定風扇的電源已經被關閉。

Other wise it may cause the sets to move suddenly, injuries and electric shock.
否則它可能會導致本機突然移動,進而引致受傷和電擊。

- Keep in a dry place, free of excessive humidity and water.
 - Keep the fan clean. Wipe away dirt with a clean soft cloth, ordinary soap and water, wipe dry. Do not use solvents.....etc.(gasoline or petroleum).
 - Do not spray with insecticides.
1. 應該保存在乾燥收藏、切忌潮濕。
2. 要保持電風扇清潔。使用潔淨布片和普通肥皂及水拭擦塵埃污漬、加以擦乾。切無使用汽油或其他化學藥品拭擦。
3. 請不要噴射殺蟲劑。

HOW TO INSTALL / 如何安裝

PARTS IDENTIFICATION / 零件識別說明

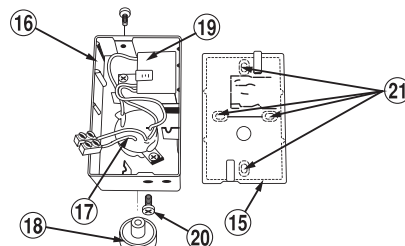
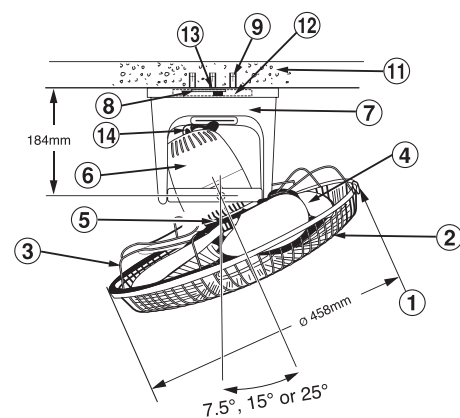

1	Guard clip	保護網環扣
2	Front guard	前網
3	Rear guard	後網
4	Blade	扇葉
5	Wing bolt	扇葉螺絲
6	Motor	馬達
7	Stand	支架
8	Fitting base	固定座
9	Carl bolt plug	支架螺絲
10	Anchor for safety wire	安全線螺絲
11	Ceiling	天花牆壁
12	Supporting plate	支撐木板
13	Set screw	固定螺絲
14	Rod	桿
15	Regulator base	調整器底
16	Regulator cover	調整器外殼
17	Switch	開關
18	Switch knob	開關旋鈕
19	Capacitor	電容器
20	Cover set screw	外殼固定螺絲
21	Fitting hole	固定螺絲孔
22	Safety wire	安全線

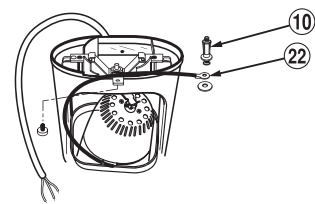

Wiring Termination / 電線總集

Live-Brown (棕線)
Neutral-Blue (藍線)
Earth-Yellow/Green (黃/青線)

HOW TO ASSEMBLE / 裝配方法

Mounting the rear guard / 裝配扇葉後罩

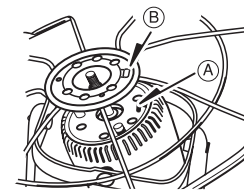

- Align the projection (A) with the hole (B) of the rear guard, and attach the rear guard to the motor.
將突出柱 (A) 安裝於後網之孔 (B) 上,然後把後網裝於馬達上。

- Re-tighten 2 wing bolts (C).
扭緊二根扇葉螺絲 (C)。

CAUTION

Please ensure the wing bolts are fully tighten to avoid guard from drop.

注意
請確保扇葉螺絲被鎖緊以防止後網掉出。

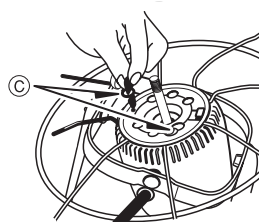

- Place the blade boss (D) onto the shaft, and push it all the way until the groove (E) of the blade boss is correctly fitted to the pin (F) of the shaft.
安裝扇葉片頭 (D) 在軸上,塞它進去直至扇葉片頭的槽 (E) 正確適當地嵌入軸針 (F)。

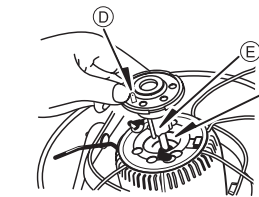

- Align the projection (G) with the hole (H) of the blade, and attach the blade to the blade boss.
將突出柱 (G) 對準扇葉上之孔 (H),然後把扇葉安裝於扇葉片頭上。

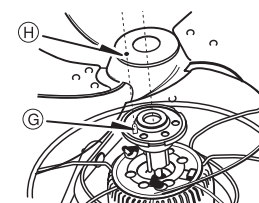

Mounting the blade 裝配扇葉

- Next turn spinner counter clockwise in order to securely tighten the blade.
逆時針方向扭轉旋轉器,使能安定地扭緊扇葉片。

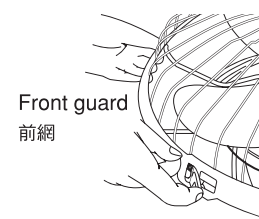
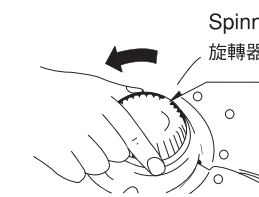

Front guard 前網

- Attach the front guard.
裝配前網。

HOW TO INSTALL THE FAN / 機身固定方法

Recommended position of earth termination point
建議安裝地線端接點的位置

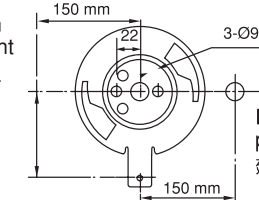

Recommended position of safety wire
建議安裝安全線的位置

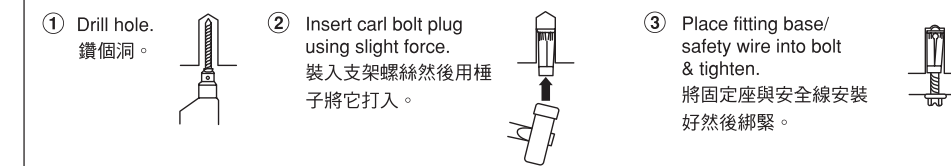

CAUTION: Raw plug & screw are not permitted. Ramsetting is not acceptable.

注意: 一概不准使用其他各類支架與螺絲。其他撞槌式的安裝法將不准使用。



- Remove the set screw and fitting base from stand base before installing the fan.
安裝前把支架的固定螺絲及固定座取下。
- Install the fitting base and carl bolt plug.
把支架及“支架螺絲”裝上。
- Install safety wire using the additional carl bolt provided. **Note:** 4 pieces Carl bolt plug will be provided.
請使用附加“支架螺絲”來安裝安全線。
: 本機提供 4 枝“支架螺絲”。

- Install the safety wire and safety cord anchor.
• A separate anchoring point must be installed according to (Fig. 1).
安裝安全線與安全線螺絲。
• 另一個安全螺絲將安裝在固定座的旁邊(如圖 1)。

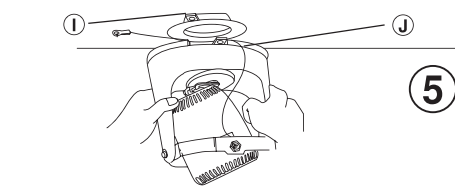

- Fix the body to the fitting base by turning the body so that the hole (J) aligns the screw hole (I).
將機身轉動至孔穴 (J) 和固定座之螺絲孔 (I) 對準。